

PRB10 塑料滚动轴承 Plastic ball bearings



PRB10作为通用性更强的塑料滚动轴承具有良好的强度和耐磨性，由于其材料自身的润滑性噪音较低；此类轴承碱性环境下表现良好但不适合在酸性环境下长期运行。标准配置内外圈材料为：改良POM，保持架材料为：改良PA，滚珠材料为：玻璃球或不锈钢（选配）；长期连续使用温度-40~+80°C。

PRB10 has good strength and wear resistance as a general plastic ball bearings, the operation noise very low because the self-lubrication of the material; These bearings perform well in an alkaline environment but not for long-term operation in an acidic environment. The standard material of inner and outer ring: POM, cage material: PA, ball material: glass or stainless steel; The long-term operation temperature: -40 ~ +80°C.

标准规格 Standard specifications

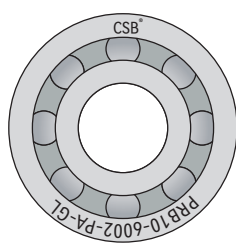
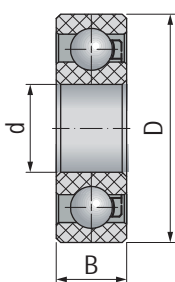

产品编码 Part No.:

PRB10-6002-PA-GL

- GL: 玻璃球 Glass balls
- ES: 不锈钢球 Stainless steel balls
- PA: PA保持架 Cage
- 轴承规格 Specification
- 型号 Type

产品编码 Part No.	产品编码 Part No.	d [mm]	D [mm]	B [mm]	极限静载荷 Max. static load [N]	极限动载荷 Max. dynamic load [N]	极限转速 Max. speed [RPM]	重量 Weight [g]
								-GL -ES
PRB10-694-PA-GL	PRB10-694-PA-ES	4	11	4	12	14	4000	0.3 0.4
PRB10-604-PA-GL	PRB10-604-PA-ES	4	12	4	30	32	3600	0.5 0.7
PRB10-624-PA-GL	PRB10-624-PA-ES	4	13	5	40	60	3600	0.7 0.9
PRB10-634-PA-GL	PRB10-634-PA-ES	4	16	5	40	40	3700	1.0 1.5
PRB10-685-PA-GL	PRB10-685-PA-ES	5	11	3	12	14	4000	0.4 0.5
PRB10-695-PA-GL	PRB10-695-PA-ES	5	13	4	29	30	3500	0.5 0.7
PRB10-605-PA-GL	PRB10-605-PA-ES	5	14	5	32	33	3500	0.8 1.0
PRB10-625-PA-GL	PRB10-625-PA-ES	5	16	5	45	65	3050	1.0 1.4
PRB10-635-PA-GL	PRB10-635-PA-ES	5	19	6	41	43	3200	1.8 2.6
PRB10-686-PA-GL	PRB10-686-PA-ES	6	13	3.5	29	30	3500	0.6 0.8
PRB10-696-PA-GL	PRB10-696-PA-ES	6	15	5	29	30	3500	0.9 1.1
PRB10-606-PA-GL	PRB10-606-PA-ES	6	17	6	50	53	3300	1.3 1.5
PRB10-626-PA-GL	PRB10-626-PA-ES	6	19	6	50	70	2600	1.8 2.8
PRB10-636-PA-GL	PRB10-636-PA-ES	6	22	7	80	94	2200	2.7 4.0
PRB10-687-PA-GL	PRB10-687-PA-ES	7	14	3.5	32	34	3200	0.6 0.8
PRB10-697-PA-GL	PRB10-697-PA-ES	7	17	5	39	41	3000	1.1 1.5
PRB10-607-PA-GL	PRB10-607-PA-ES	7	19	6	50	70	2600	1.5 2.2
PRB10-627-PA-GL	PRB10-627-PA-ES	7	22	7	55	80	2200	2.6 3.9
PRB10-688-PA-GL	PRB10-688-PA-ES	8	16	4	39	41	3000	2.6 3.9
PRB10-698-PA-GL	PRB10-698-PA-ES	8	19	6	60	62	3200	1.5 2.3
PRB10-608-PA-GL	PRB10-608-PA-ES	8	22	7	55	80	2200	2.4 3.6
PRB10-628-PA-GL	PRB10-628-PA-ES	8	24	8	100	110	2300	3.4 5.6
PRB10-638-PA-GL	PRB10-638-PA-ES	8	28	9	110	130	2200	5.7 7.8
PRB10-689-PA-GL	PRB10-689-PA-ES	9	17	4	40	42	2500	0.9 1.3
PRB10-699-PA-GL	PRB10-699-PA-ES	9	20	6	43	45	2250	1.7 2.1
PRB10-609-PA-GL	PRB10-609-PA-ES	9	24	7	60	90	2050	6.6 7.8
PRB10-629-PA-GL	PRB10-629-PA-ES	9	26	8	70	100	1900	4.1 6.3
PRB10-6800-PA-GL	PRB10-6800-PA-ES	10	19	5	43	45	2250	1.7 2.1
PRB10-6900-PA-GL	PRB10-6900-PA-ES	10	22	6	60	64	2000	2.0 3.3
PRB10-6000-PA-GL	PRB10-6000-PA-ES	10	26	8	90	130	1900	4.1 6.2

产品编码 Part No.	产品编码 Part No.	d [mm]	D [mm]	B [mm]	极限静载荷 Max. static load [N]	极限动载荷 Max. dynamic load [N]	极限转速 Max. speed [RPM]	重量 Weight [g]	
								-GL	-ES
PRB10-6200-PA-GL	PRB10-6200-PA-ES	10	30	9	110	160	1650	6.5	8.9
PRB10-6300-PA-GL	PRB10-6300-PA-ES	10	35	11	190	280	1400	11.3	17.4
PRB10-6801-PA-GL	PRB10-6801-PA-ES	12	21	5	60	64	2000	1.4	1.8
PRB10-6901-PA-GL	PRB10-6901-PA-ES	12	24	6	80	83	1800	2.1	3.1
PRB10-6001-PA-GL	PRB10-6001-PA-ES	12	28	8	110	160	1750	4.6	7.1
PRB10-6201-PA-GL	PRB10-6201-PA-ES	12	32	10	150	220	1550	7.7	11.9
PRB10-6301-PA-GL	PRB10-6301-PA-ES	12	37	12	210	310	1300	13.4	21.8
PRB10-6802-PA-GL	PRB10-6802-PA-ES	15	24	5	80	83	1800	1.5	2.5
PRB10-6902-PA-GL	PRB10-6902-PA-ES	15	28	7	90	94	1700	3.1	4.4
PRB10-16002-PA-GL	PRB10-16002-PA-ES	15	32	8	130	190	1500	5.5	8.0
PRB10-6002-PA-GL	PRB10-6002-PA-ES	15	32	9	140	200	1500	6.4	9.1
PRB10-6202-PA-GL	PRB10-6202-PA-ES	15	35	11	170	250	1400	9.4	14.3
PRB10-6302-PA-GL	PRB10-6302-PA-ES	15	42	13	260	370	1200	17.5	27.3
PRB10-6803-PA-GL	PRB10-6803-PA-ES	17	26	5	90	94	1700	1.7	2.8
PRB10-6903-PA-GL	PRB10-6903-PA-ES	17	30	7	90	94	1700	0.8	1.4
PRB10-16003-PA-GL	PRB10-16003-PA-ES	17	35	8	160	240	1400	6.6	9.6
PRB10-6003-PA-GL	PRB10-6003-PA-ES	17	35	10	170	260	1400	8.4	11.4
PRB10-6203-PA-GL	PRB10-6203-PA-ES	17	40	12	220	320	1250	13.9	19.1
PRB10-6303-PA-GL	PRB10-6303-PA-ES	17	47	14	260	370	1050	24.5	37.5
PRB10-6804-PA-GL	PRB10-6804-PA-ES	20	32	7	100	120	1500	3.6	5.2
PRB10-6904-PA-GL	PRB10-6904-PA-ES	20	37	9	140	144	1150	6.8	9.8
PRB10-16004-PA-GL	PRB10-16004-PA-ES	20	42	8	190	290	1150	9.8	13.8
PRB10-6004-PA-GL	PRB10-6004-PA-ES	20	42	12	200	300	1150	14.2	20.7
PRB10-6204-PA-GL	PRB10-6204-PA-ES	20	47	14	270	420	1050	22.1	33.4
PRB10-6304-PA-GL	PRB10-6304-PA-ES	20	52	15	350	500	950	31.7	48.6
PRB10-6805-PA-GL	PRB10-6805-PA-ES	25	37	7	140	144	1150	4.2	6.5
PRB10-6905-PA-GL	PRB10-6905-PA-ES	25	42	9	160	162	900	4.5	4.5
PRB10-16005-PA-GL	PRB10-16005-PA-ES	25	47	8	210	310	1050	10.9	19.1
PRB10-6005-PA-GL	PRB10-6005-PA-ES	25	47	12	240	360	1050	1.6	23.8
PRB10-6205-PA-GL	PRB10-6205-PA-ES	25	52	15	320	480	950	27.0	39.6
PRB10-6305-PA-GL	PRB10-6305-PA-ES	25	62	17	400	600	725	49.5	76.4
PRB10-6806-PA-GL	PRB10-6806-PA-ES	30	42	7	190	193	850	10.1	13.2
PRB10-6906-PA-GL	PRB10-6906-PA-ES	30	47	9	380	400	1000	17.0	28.5
PRB10-16006-PA-GL	PRB10-16006-PA-ES	30	55	9	240	370	900	17.3	26.2
PRB10-6006-PA-GL	PRB10-6006-PA-ES	30	55	13	280	420	900	24.2	35.4
PRB10-6206-PA-GL	PRB10-6206-PA-ES	30	62	16	360	550	800	41.6	63.4
PRB10-6306-PA-GL	PRB10-6306-PA-ES	30	72	19	460	700	675	72.0	113.8
PRB10-16007-PA-GL	PRB10-16007-PA-ES	35	62	9	270	410	800	21.8	32.3
PRB10-6007-PA-GL	PRB10-6007-PA-ES	35	62	14	320	480	800	32.0	47.4
PRB10-6207-PA-GL	PRB10-6207-PA-ES	35	72	17	410	620	700	60.3	94.9
PRB10-6307-PA-GL	PRB10-6307-PA-ES	35	80	21	490	750	600	98.7	153.7
PRB10-16008-PA-GL	PRB10-16008-PA-ES	40	68	9	300	450	750	29.3	37.7
PRB10-6008-PA-GL	PRB10-6008-PA-ES	40	68	15	350	520	750	39.4	52.3
PRB10-6208-PA-GL	PRB10-6208-PA-ES	40	80	18	440	660	625	79.8	131.4
PRB10-6308-PA-GL	PRB10-6308-PA-ES	40	90	23	520	800	575	130.7	207.5
PRB10-16009-PA-GL	PRB10-16009-PA-ES	45	75	10	330	500	650	33.6	48.9
PRB10-6009-PA-GL	PRB10-6009-PA-ES	45	75	16	380	560	650	50.6	74.8
PRB10-6209-PA-GL	PRB10-6209-PA-ES	45	85	19	470	720	580	86.3	138.0
PRB10-6309-PA-GL	PRB10-6309-PA-ES	45	100	25	540	900	500	177.1	296.4
PRB10-6010-PA-GL	PRB10-6010-PA-ES	50	80	16	390	580	600	55.9	82.0
PRB10-6210-PA-GL	PRB10-6210-PA-ES	50	90	20	540	770	550	96.5	153.8

PRB15 塑料滚动轴承 Plastic ball bearings

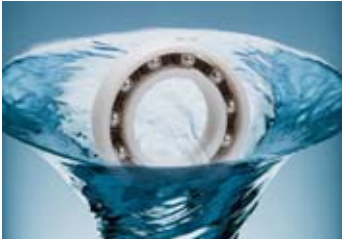

PRB15塑料滚动轴承材料具有极好的强度和耐磨性能，无论是在潮湿环境还是水下均保持良好的尺寸稳定性；对有机溶剂以及过氧化氢等具有良好的抗性；标准配置内外圈材料为：改良PETR，保持架材料为：改良PA，滚珠材料为：玻璃或不锈钢（选配）；长期使用温度：-50~+120°C。

PRB15 plastic ball bearings are with excellent strength and wear resistance. The dimensions of the bearings are remaining stable either in the humidity environment or in the water. It has good chemical resistance against the organic solvents or Hydrogen peroxide. The standard material of the inner and outer ring is PETR, the ball cage is PA, and the balls are glass or stainless steel. The working temperature range is -50 ~ +120°C.

标准规格 Standard specifications

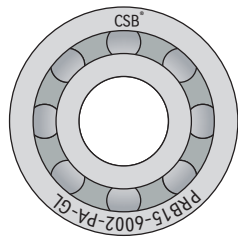
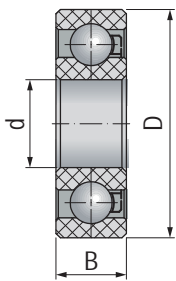

产品编码 Part No.:

PRB15-6002-PA-GL

GL: 玻璃球 Glass balls

ES: 不锈钢球 Stainless steel balls

PA: PA保持架 Cage

轴承规格 Specification

型号 Type

产品编码 Part No.	产品编码 Part No.	d [mm]	D [mm]	B [mm]	极限静载荷 Max. static load [N]	极限动载荷 Max. dynamic load [N]	极限转速 Max. speed [RPM]	重量 Weight [g]	-GL	-ES
PRB15-694-PA-GL	PRB15-694-PA-ES	4	11	4	13	15	2600	0.3	0.4	
PRB15-604-PA-GL	PRB15-604-PA-ES	4	12	4	32	34	2340	0.5	0.7	
PRB15-624-PA-GL	PRB15-624-PA-ES	4	13	5	43	64	2340	0.7	0.9	
PRB15-634-PA-GL	PRB15-634-PA-ES	4	16	5	43	43	2405	1.0	1.5	
PRB15-685-PA-GL	PRB15-685-PA-ES	5	11	3	13	15	2600	0.4	0.5	
PRB15-695-PA-GL	PRB15-695-PA-ES	5	13	4	31	32	2275	0.5	0.7	
PRB15-605-PA-GL	PRB15-605-PA-ES	5	14	5	34	35	2275	0.8	1.0	
PRB15-625-PA-GL	PRB15-625-PA-ES	5	16	5	48	70	1983	1.0	1.4	
PRB15-635-PA-GL	PRB15-635-PA-ES	5	19	6	44	46	2080	1.8	2.6	
PRB15-686-PA-GL	PRB15-686-PA-ES	6	13	3.5	31	32	2275	0.6	0.8	
PRB15-696-PA-GL	PRB15-696-PA-ES	6	15	5	31	32	2275	0.9	1.1	
PRB15-606-PA-GL	PRB15-606-PA-ES	6	17	6	54	57	2145	1.3	1.5	
PRB15-626-PA-GL	PRB15-626-PA-ES	6	19	6	54	75	1690	1.8	2.8	
PRB15-636-PA-GL	PRB15-636-PA-ES	6	22	7	86	101	1430	2.7	4.0	
PRB15-687-PA-GL	PRB15-687-PA-ES	7	14	3.5	34	36	2080	0.6	0.8	
PRB15-697-PA-GL	PRB15-697-PA-ES	7	17	5	42	44	1950	1.1	1.5	
PRB15-607-PA-GL	PRB15-607-PA-ES	7	19	6	54	75	1690	1.5	2.2	
PRB15-627-PA-GL	PRB15-627-PA-ES	7	22	7	59	86	1430	2.6	3.9	
PRB15-688-PA-GL	PRB15-688-PA-ES	8	16	4	42	44	1950	2.6	3.9	
PRB15-698-PA-GL	PRB15-698-PA-ES	8	19	6	64	66	2080	1.5	2.3	
PRB15-608-PA-GL	PRB15-608-PA-ES	8	22	7	59	86	1430	2.4	3.6	
PRB15-628-PA-GL	PRB15-628-PA-ES	8	24	8	107	118	1495	3.4	5.6	
PRB15-638-PA-GL	PRB15-638-PA-ES	8	28	9	118	139	1430	5.7	7.8	
PRB15-689-PA-GL	PRB15-689-PA-ES	9	17	4	43	45	1625	0.9	1.3	
PRB15-699-PA-GL	PRB15-699-PA-ES	9	20	6	46	48	1463	1.7	2.1	
PRB15-609-PA-GL	PRB15-609-PA-ES	9	24	7	64	96	1333	6.6	7.8	
PRB15-629-PA-GL	PRB15-629-PA-ES	9	26	8	75	107	1235	4.1	6.3	
PRB15-6800-PA-GL	PRB15-6800-PA-ES	10	19	5	46	48	1463	1.7	2.1	
PRB15-6900-PA-GL	PRB15-6900-PA-ES	10	22	6	64	68	1300	2.0	3.3	
PRB15-6000-PA-GL	PRB15-6000-PA-ES	10	26	8	96	139	1235	4.1	6.2	

产品编码 Part No.	产品编码 Part No.	d [mm]	D [mm]	B [mm]	极限静载荷 Max. static load [N]	极限动载荷 Max. dynamic load [N]	极限转速 Max. speed [RPM]	重量 Weight [g]	
								-GL	-ES
PRB15-6200-PA-GL	PRB15-6200-PA-ES	10	30	9	118	171	1073	6.5	8.9
PRB15-6300-PA-GL	PRB15-6300-PA-ES	10	35	11	203	300	910	11.3	17.4
PRB15-6801-PA-GL	PRB15-6801-PA-ES	12	21	5	64	68	1300	1.4	1.8
PRB15-6901-PA-GL	PRB15-6901-PA-ES	12	24	6	86	89	1170	2.1	3.1
PRB15-6001-PA-GL	PRB15-6001-PA-ES	12	28	8	118	171	1138	4.6	7.1
PRB15-6201-PA-GL	PRB15-6201-PA-ES	12	32	10	161	235	1008	7.7	11.9
PRB15-6301-PA-GL	PRB15-6301-PA-ES	12	37	12	225	332	845	13.4	21.8
PRB15-6802-PA-GL	PRB15-6802-PA-ES	15	24	5	86	89	1170	1.5	2.5
PRB15-6902-PA-GL	PRB15-6902-PA-ES	15	28	7	96	101	1105	3.1	4.4
PRB15-16002-PA-GL	PRB15-16002-PA-ES	15	32	8	139	203	975	5.5	8.0
PRB15-6002-PA-GL	PRB15-6002-PA-ES	15	32	9	150	214	975	6.4	9.1
PRB15-6202-PA-GL	PRB15-6202-PA-ES	15	35	11	182	268	910	9.4	14.3
PRB15-6302-PA-GL	PRB15-6302-PA-ES	15	42	13	278	396	780	17.5	27.3
PRB15-6803-PA-GL	PRB15-6803-PA-ES	17	26	5	96	101	1105	1.7	2.8
PRB15-6903-PA-GL	PRB15-6903-PA-ES	17	30	7	96	101	1105	0.8	1.4
PRB15-16003-PA-GL	PRB15-16003-PA-ES	17	35	8	171	257	910	6.6	9.6
PRB15-6003-PA-GL	PRB15-6003-PA-ES	17	35	10	182	278	910	8.4	11.4
PRB15-6203-PA-GL	PRB15-6203-PA-ES	17	40	12	235	342	813	13.9	19.1
PRB15-6303-PA-GL	PRB15-6303-PA-ES	17	47	14	278	396	683	24.5	37.5
PRB15-6804-PA-GL	PRB15-6804-PA-ES	20	32	7	107	128	975	3.6	5.2
PRB15-6904-PA-GL	PRB15-6904-PA-ES	20	37	9	150	154	748	6.8	9.8
PRB15-16004-PA-GL	PRB15-16004-PA-ES	20	42	8	203	310	748	9.8	13.8
PRB15-6004-PA-GL	PRB15-6004-PA-ES	20	42	12	214	321	748	14.2	20.7
PRB15-6204-PA-GL	PRB15-6204-PA-ES	20	47	14	289	449	683	22.1	33.4
PRB15-6304-PA-GL	PRB15-6304-PA-ES	20	52	15	375	535	618	31.7	48.6
PRB15-6805-PA-GL	PRB15-6805-PA-ES	25	37	7	150	154	748	4.2	6.5
PRB15-6905-PA-GL	PRB15-6905-PA-ES	25	42	9	171	173	585	4.5	4.5
PRB15-16005-PA-GL	PRB15-16005-PA-ES	25	47	8	225	332	683	10.9	19.1
PRB15-6005-PA-GL	PRB15-6005-PA-ES	25	47	12	257	385	683	1.6	23.8
PRB15-6205-PA-GL	PRB15-6205-PA-ES	25	52	15	342	514	618	27.0	39.6
PRB15-6305-PA-GL	PRB15-6305-PA-ES	25	62	17	428	642	471	49.5	76.4
PRB15-6806-PA-GL	PRB15-6806-PA-ES	30	42	7	203	207	553	10.1	13.2
PRB15-6906-PA-GL	PRB15-6906-PA-ES	30	47	9	407	428	650	17.0	28.5
PRB15-16006-PA-GL	PRB15-16006-PA-ES	30	55	9	257	396	585	17.3	26.2
PRB15-6006-PA-GL	PRB15-6006-PA-ES	30	55	13	300	449	585	24.2	35.4
PRB15-6206-PA-GL	PRB15-6206-PA-ES	30	62	16	385	589	520	41.6	63.4
PRB15-6306-PA-GL	PRB15-6306-PA-ES	30	72	19	492	749	439	72.0	113.8
PRB15-16007-PA-GL	PRB15-16007-PA-ES	35	62	9	289	439	520	21.8	32.3
PRB15-6007-PA-GL	PRB15-6007-PA-ES	35	62	14	342	514	520	32.0	47.4
PRB15-6207-PA-GL	PRB15-6207-PA-ES	35	72	17	439	663	455	60.3	94.9
PRB15-6307-PA-GL	PRB15-6307-PA-ES	35	80	21	524	803	390	98.7	153.7
PRB15-16008-PA-GL	PRB15-16008-PA-ES	40	68	9	321	482	488	29.3	37.7
PRB15-6008-PA-GL	PRB15-6008-PA-ES	40	68	15	375	556	488	39.4	52.3
PRB15-6208-PA-GL	PRB15-6208-PA-ES	40	80	18	471	706	406	79.8	131.4
PRB15-6308-PA-GL	PRB15-6308-PA-ES	40	90	23	556	856	374	130.7	207.5
PRB15-16009-PA-GL	PRB15-16009-PA-ES	45	75	10	353	535	423	33.6	48.9
PRB15-6009-PA-GL	PRB15-6009-PA-ES	45	75	16	407	599	423	50.6	74.8
PRB15-6209-PA-GL	PRB15-6209-PA-ES	45	85	19	503	770	377	86.3	138.0
PRB15-6309-PA-GL	PRB15-6309-PA-ES	45	100	25	578	963	325	177.1	296.4
PRB15-6010-PA-GL	PRB15-6010-PA-ES	50	80	16	417	621	390	55.9	82.0
PRB15-6210-PA-GL	PRB15-6210-PA-ES	50	90	20	578	824	358	96.5	153.8

PRB20 塑料滚动轴承 Plastic ball bearings

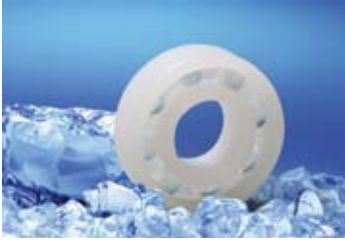

PRB20塑料滚动轴承具有低摩擦以及低温应用特性；此类轴承适合在酸碱交替环境下长期运行。标准配置内外圈材料为：改良UPE，保持架材料为：改良UPE，滚珠材料为：玻璃球或不锈钢（选配）；长期连续使用温度-150 ~ +80°C。

PRB20 series of plastic ball bearings with low friction and low working temperature properties; these bearings are suitable for long-term operation in the acid-base alternate environment. The standard material of inner and outer ring: UPE, cage material: UPE, ball material: glass or stainless steel; The long-term operation temperature: -150 ~ +80°C.

标准规格 Standard specifications

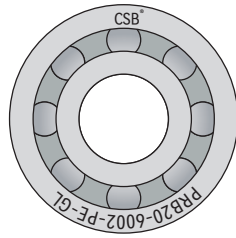
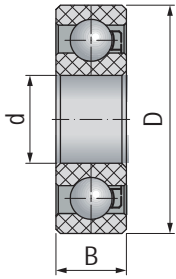

产品编码 Part No.:

PRB20-6002-PE-GL

GL: 玻璃球 Glass balls

ES: 不锈钢球 Stainless steel balls

PE: UPE保持架 cage

轴承规格 Specification

型号 Type

产品编码 Part No.	产品编码 Part No.	d [mm]	D [mm]	B [mm]	极限静载荷 Max. static load [N]	极限动载荷 Max. dynamic load [N]	极限转速 Max. speed [RPM]	重量 Weight [g]	-GL	-ES
PRB20-694-PE-GL	PRB20-694-PE-ES	4	11	4	10	11	1560	0.3	0.4	
PRB20-604-PE-GL	PRB20-604-PE-ES	4	12	4	25	26	1404	0.4	0.7	
PRB20-624-PE-GL	PRB20-624-PE-ES	4	13	5	33	49	1404	0.6	0.9	
PRB20-634-PE-GL	PRB20-634-PE-ES	4	16	5	33	33	1443	0.9	1.4	
PRB20-685-PE-GL	PRB20-685-PE-ES	5	11	3	10	11	1560	0.3	0.5	
PRB20-695-PE-GL	PRB20-695-PE-ES	5	13	4	24	25	1365	0.4	0.7	
PRB20-605-PE-GL	PRB20-605-PE-ES	5	14	5	26	27	1365	0.7	1.0	
PRB20-625-PE-GL	PRB20-625-PE-ES	5	16	5	37	53	1190	0.9	1.3	
PRB20-635-PE-GL	PRB20-635-PE-ES	5	19	6	34	35	1248	1.6	2.5	
PRB20-686-PE-GL	PRB20-686-PE-ES	6	13	3.5	24	25	1365	0.5	0.8	
PRB20-696-PE-GL	PRB20-696-PE-ES	6	15	5	24	25	1365	0.8	1.0	
PRB20-606-PE-GL	PRB20-606-PE-ES	6	17	6	41	43	1287	1.1	1.4	
PRB20-626-PE-GL	PRB20-626-PE-ES	6	19	6	41	57	1014	1.6	2.7	
PRB20-636-PE-GL	PRB20-636-PE-ES	6	22	7	66	77	858	2.3	3.8	
PRB20-687-PE-GL	PRB20-687-PE-ES	7	14	3.5	26	28	1248	0.5	0.8	
PRB20-697-PE-GL	PRB20-697-PE-ES	7	17	5	32	34	1170	1.0	1.4	
PRB20-607-PE-GL	PRB20-607-PE-ES	7	19	6	41	57	1014	1.3	2.1	
PRB20-627-PE-GL	PRB20-627-PE-ES	7	22	7	45	66	858	2.3	3.7	
PRB20-688-PE-GL	PRB20-688-PE-ES	8	16	4	32	34	1170	2.3	3.7	
PRB20-698-PE-GL	PRB20-698-PE-ES	8	19	6	49	51	1248	1.3	2.2	
PRB20-608-PE-GL	PRB20-608-PE-ES	8	22	7	45	66	858	2.1	3.4	
PRB20-628-PE-GL	PRB20-628-PE-ES	8	24	8	82	90	897	3.0	5.3	
PRB20-638-PE-GL	PRB20-638-PE-ES	8	28	9	90	107	858	5.0	7.4	
PRB20-689-PE-GL	PRB20-689-PE-ES	9	17	4	33	34	975	0.8	1.2	
PRB20-699-PE-GL	PRB20-699-PE-ES	9	20	6	35	37	878	1.5	2.0	
PRB20-609-PE-GL	PRB20-609-PE-ES	9	24	7	49	74	800	5.7	7.4	
PRB20-629-PE-GL	PRB20-629-PE-ES	9	26	8	57	82	741	3.6	6.0	
PRB20-6800-PE-GL	PRB20-6800-PE-ES	10	19	5	35	37	878	1.5	2.0	
PRB20-6900-PE-GL	PRB20-6900-PE-ES	10	22	6	49	52	780	1.7	3.1	
PRB20-6000-PE-GL	PRB20-6000-PE-ES	10	26	8	74	107	741	3.6	5.9	

产品编码 Part No.	产品编码 Part No.	d [mm]	D [mm]	B [mm]	极限静载荷 Max. static load [N]	极限动载荷 Max. dynamic load [N]	极限转速 Max. speed [RPM]	重量 Weight [g]	
								-GL	-ES
PRB20-6200-PE-GL	PRB20-6200-PE-ES	10	30	9	90	131	644	5.7	8.5
PRB20-6300-PE-GL	PRB20-6300-PE-ES	10	35	11	156	230	546	9.8	16.5
PRB20-6801-PE-GL	PRB20-6801-PE-ES	12	21	5	49	52	780	1.2	1.7
PRB20-6901-PE-GL	PRB20-6901-PE-ES	12	24	6	66	68	702	1.8	2.9
PRB20-6001-PE-GL	PRB20-6001-PE-ES	12	28	8	90	131	683	4.0	6.7
PRB20-6201-PE-GL	PRB20-6201-PE-ES	12	32	10	123	180	605	6.7	11.3
PRB20-6301-PE-GL	PRB20-6301-PE-ES	12	37	12	172	254	507	11.7	20.7
PRB20-6802-PE-GL	PRB20-6802-PE-ES	15	24	5	66	68	702	1.3	2.4
PRB20-6902-PE-GL	PRB20-6902-PE-ES	15	28	7	74	77	663	2.7	4.2
PRB20-16002-PE-GL	PRB20-16002-PE-ES	15	32	8	107	156	585	4.8	7.6
PRB20-6002-PE-GL	PRB20-6002-PE-ES	15	32	9	115	164	585	5.6	8.6
PRB20-6202-PE-GL	PRB20-6202-PE-ES	15	35	11	139	205	546	8.2	13.6
PRB20-6302-PE-GL	PRB20-6302-PE-ES	15	42	13	213	303	468	15.2	25.9
PRB20-6803-PE-GL	PRB20-6803-PE-ES	17	26	5	74	77	663	1.5	2.7
PRB20-6903-PE-GL	PRB20-6903-PE-ES	17	30	7	74	77	663	0.7	1.3
PRB20-16003-PE-GL	PRB20-16003-PE-ES	17	35	8	131	197	546	5.7	9.1
PRB20-6003-PE-GL	PRB20-6003-PE-ES	17	35	10	139	213	546	7.3	10.8
PRB20-6203-PE-GL	PRB20-6203-PE-ES	17	40	12	180	262	488	12.1	18.1
PRB20-6303-PE-GL	PRB20-6303-PE-ES	17	47	14	213	303	410	21.3	35.6
PRB20-6804-PE-GL	PRB20-6804-PE-ES	20	32	7	82	98	585	3.1	4.9
PRB20-6904-PE-GL	PRB20-6904-PE-ES	20	37	9	115	118	449	5.9	9.3
PRB20-16004-PE-GL	PRB20-16004-PE-ES	20	42	8	156	238	449	8.5	13.1
PRB20-6004-PE-GL	PRB20-6004-PE-ES	20	42	12	164	246	449	12.4	19.7
PRB20-6204-PE-GL	PRB20-6204-PE-ES	20	47	14	221	344	410	19.2	31.7
PRB20-6304-PE-GL	PRB20-6304-PE-ES	20	52	15	287	410	371	27.6	46.2
PRB20-6805-PE-GL	PRB20-6805-PE-ES	25	37	7	115	118	449	3.7	6.2
PRB20-6905-PE-GL	PRB20-6905-PE-ES	25	42	9	131	133	351	3.9	4.3
PRB20-16005-PE-GL	PRB20-16005-PE-ES	25	47	8	172	254	410	9.5	18.1
PRB20-6005-PE-GL	PRB20-6005-PE-ES	25	47	12	197	295	410	1.4	22.6
PRB20-6205-PE-GL	PRB20-6205-PE-ES	25	52	15	262	394	371	23.5	37.6
PRB20-6305-PE-GL	PRB20-6305-PE-ES	25	62	17	328	492	283	43.1	72.6
PRB20-6806-PE-GL	PRB20-6806-PE-ES	30	42	7	156	158	332	8.8	12.5
PRB20-6906-PE-GL	PRB20-6906-PE-ES	30	47	9	312	328	390	14.8	27.1
PRB20-16006-PE-GL	PRB20-16006-PE-ES	30	55	9	197	303	351	15.1	24.9
PRB20-6006-PE-GL	PRB20-6006-PE-ES	30	55	13	230	344	351	21.1	33.6
PRB20-6206-PE-GL	PRB20-6206-PE-ES	30	62	16	295	451	312	36.2	60.2
PRB20-6306-PE-GL	PRB20-6306-PE-ES	30	72	19	377	574	263	62.6	108.1
PRB20-16007-PE-GL	PRB20-16007-PE-ES	35	62	9	221	336	312	19.0	30.7
PRB20-6007-PE-GL	PRB20-6007-PE-ES	35	62	14	262	394	312	27.8	45.0
PRB20-6207-PE-GL	PRB20-6207-PE-ES	35	72	17	336	508	273	52.5	90.2
PRB20-6307-PE-GL	PRB20-6307-PE-ES	35	80	21	402	615	234	85.9	146.0
PRB20-16008-PE-GL	PRB20-16008-PE-ES	40	68	9	246	369	293	25.5	35.8
PRB20-6008-PE-GL	PRB20-6008-PE-ES	40	68	15	287	426	293	34.3	49.7
PRB20-6208-PE-GL	PRB20-6208-PE-ES	40	80	18	361	541	244	69.4	124.8
PRB20-6308-PE-GL	PRB20-6308-PE-ES	40	90	23	426	656	224	113.7	197.1
PRB20-16009-PE-GL	PRB20-16009-PE-ES	45	75	10	271	410	254	29.2	46.5
PRB20-6009-PE-GL	PRB20-6009-PE-ES	45	75	16	312	459	254	44.0	71.1
PRB20-6209-PE-GL	PRB20-6209-PE-ES	45	85	19	385	590	226	75.1	131.1
PRB20-6309-PE-GL	PRB20-6309-PE-ES	45	100	25	443	738	195	154.1	281.6
PRB20-6010-PE-GL	PRB20-6010-PE-ES	50	80	16	320	476	234	48.6	77.9
PRB20-6210-PE-GL	PRB20-6210-PE-ES	50	90	20	443	631	215	84.0	146.1

PRB25 塑料滚动轴承 Plastic ball bearings



PRB25塑料滚动轴承材料是经过摩擦优化的耐磨材料，具有较低的摩擦系数；耐疲劳性较好；允许在高速下运转。耐碱、弱酸以及洗涤剂的腐蚀；标准配置内外圈材料为：改良PA，保持架材料为：改良PA，滚珠材料为：玻璃或不锈钢（选配）；长期使用温度：-40~+100°C。

PRB25 plastic ball bearings material is friction optimized wear resistance material with low friction and good fatigue resistance. It is suitable for the high speed operation. The material is alkali, acid and detergent resistance. The standard material of inner and outer ring is PA, ball cage is PA and the balls are glass or stainless steel. The working temperature range is -40~+100°C.

标准规格 Standard specifications

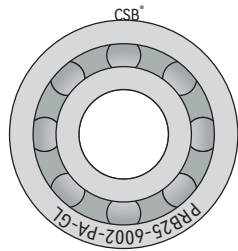
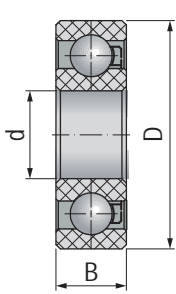

产品编码 Part No.:

PRB25-6002-PA-GL

- GL: 玻璃球 Glass balls
- ES: 不锈钢球 Stainless steel balls
- PA: PA保持架 Cage
- 轴承规格 Specification
- 型号 Type

产品编码 Part No.	产品编码 Part No.	d [mm]	D [mm]	B [mm]	极限静载荷 Max. static load [N]	极限动载荷 Max. dynamic load [N]	极限转速 Max. speed [RPM]	重量 Weight [g]	
								-GL	-ES
PRB25-636-PA-GL	PRB25-636-PA-ES	6	22	7	84	99	1980	2.5	3.9
PRB25-627-PA-GL	PRB25-627-PA-ES	7	22	7	58	84	1980	2.4	3.8
PRB25-608-PA-GL	PRB25-608-PA-ES	8	22	7	58	84	1980	2.2	3.5
PRB25-628-PA-GL	PRB25-628-PA-ES	8	24	8	105	116	2070	3.2	5.4
PRB25-638-PA-GL	PRB25-638-PA-ES	8	28	9	116	137	1980	5.3	7.6
PRB25-699-PA-GL	PRB25-699-PA-ES	9	20	6	45	47	2025	1.6	2.0
PRB25-609-PA-GL	PRB25-609-PA-ES	9	24	7	63	95	1845	6.1	7.6
PRB25-629-PA-GL	PRB25-629-PA-ES	9	26	8	74	105	1710	3.8	6.1
PRB25-6900-PA-GL	PRB25-6900-PA-ES	10	22	6	63	67	1800	1.9	3.2
PRB25-6000-PA-GL	PRB25-6000-PA-ES	10	26	8	95	137	1710	3.8	6.0
PRB25-6200-PA-GL	PRB25-6200-PA-ES	10	30	9	116	168	1485	6.0	8.6
PRB25-6300-PA-GL	PRB25-6300-PA-ES	10	35	11	200	294	1260	10.5	16.9
PRB25-6901-PA-GL	PRB25-6901-PA-ES	12	24	6	84	87	1620	2.0	3.0
PRB25-6001-PA-GL	PRB25-6001-PA-ES	12	28	8	116	168	1575	4.3	6.9
PRB25-6201-PA-GL	PRB25-6201-PA-ES	12	32	10	158	231	1395	7.2	11.5
PRB25-6301-PA-GL	PRB25-6301-PA-ES	12	37	12	221	326	1170	12.5	21.1
PRB25-6802-PA-GL	PRB25-6802-PA-ES	15	24	5	84	87	1620	1.4	2.4
PRB25-6902-PA-GL	PRB25-6902-PA-ES	15	28	7	95	99	1530	2.9	4.3
PRB25-16002-PA-GL	PRB25-16002-PA-ES	15	32	8	137	200	1350	5.1	7.8
PRB25-6002-PA-GL	PRB25-6002-PA-ES	15	32	9	147	210	1350	6.0	8.8
PRB25-6202-PA-GL	PRB25-6202-PA-ES	15	35	11	179	263	1260	8.7	13.9
PRB25-6302-PA-GL	PRB25-6302-PA-ES	15	42	13	273	389	1080	16.3	26.5
PRB25-6803-PA-GL	PRB25-6803-PA-ES	17	26	5	95	99	1530	1.6	2.7

产品编码 Part No.	产品编码 Part No.	d [mm]	D [mm]	B [mm]	极限静载荷 Max. static load [N]	极限动载荷 Max. dynamic load [N]	极限转速 Max. speed [RPM]	重量 Weight [g]	
								-GL	-ES
PRB25-6903-PA-GL	PRB25-6903-PA-ES	17	30	7	95	99	1530	0.7	1.4
PRB25-16003-PA-GL	PRB25-16003-PA-ES	17	35	8	168	252	1260	6.1	9.3
PRB25-6003-PA-GL	PRB25-6003-PA-ES	17	35	10	179	273	1260	7.8	11.1
PRB25-6203-PA-GL	PRB25-6203-PA-ES	17	40	12	231	336	1125	12.9	18.5
PRB25-6303-PA-GL	PRB25-6303-PA-ES	17	47	14	273	389	945	22.8	36.4
PRB25-6804-PA-GL	PRB25-6804-PA-ES	20	32	7	105	126	1350	3.3	5.0
PRB25-6904-PA-GL	PRB25-6904-PA-ES	20	37	9	147	151	1035	6.3	9.5
PRB25-16004-PA-GL	PRB25-16004-PA-ES	20	42	8	200	305	1035	9.1	13.4
PRB25-6004-PA-GL	PRB25-6004-PA-ES	20	42	12	210	315	1035	13.2	20.1
PRB25-6204-PA-GL	PRB25-6204-PA-ES	20	47	14	284	441	945	20.6	32.4
PRB25-6304-PA-GL	PRB25-6304-PA-ES	20	52	15	368	525	855	29.5	47.1
PRB25-6805-PA-GL	PRB25-6805-PA-ES	25	37	7	147	151	1035	3.9	6.3
PRB25-6905-PA-GL	PRB25-6905-PA-ES	25	42	9	168	170	810	4.2	4.4
PRB25-16005-PA-GL	PRB25-16005-PA-ES	25	47	8	221	326	945	10.1	18.5
PRB25-6005-PA-GL	PRB25-6005-PA-ES	25	47	12	252	378	945	1.5	23.1
PRB25-6205-PA-GL	PRB25-6205-PA-ES	25	52	15	336	504	855	25.1	38.4
PRB25-6305-PA-GL	PRB25-6305-PA-ES	25	62	17	420	630	653	46.0	74.1
PRB25-6806-PA-GL	PRB25-6806-PA-ES	30	42	7	200	203	765	9.4	12.8
PRB25-6906-PA-GL	PRB25-6906-PA-ES	30	47	9	399	420	900	15.8	27.6
PRB25-16006-PA-GL	PRB25-16006-PA-ES	30	55	9	252	389	810	16.1	25.4
PRB25-6006-PA-GL	PRB25-6006-PA-ES	30	55	13	294	441	810	22.5	34.3
PRB25-6206-PA-GL	PRB25-6206-PA-ES	30	62	16	378	578	720	38.7	61.5
PRB25-6306-PA-GL	PRB25-6306-PA-ES	30	72	19	483	735	608	67.0	110.4
PRB25-16007-PA-GL	PRB25-16007-PA-ES	35	62	9	284	431	720	20.3	31.3
PRB25-6007-PA-GL	PRB25-6007-PA-ES	35	62	14	336	504	720	29.8	46.0
PRB25-6207-PA-GL	PRB25-6207-PA-ES	35	72	17	431	651	630	56.1	92.1
PRB25-6307-PA-GL	PRB25-6307-PA-ES	35	80	21	515	788	540	91.8	149.1
PRB25-16008-PA-GL	PRB25-16008-PA-ES	40	68	9	315	473	675	27.2	36.6
PRB25-6008-PA-GL	PRB25-6008-PA-ES	40	68	15	368	546	675	36.6	50.7
PRB25-6208-PA-GL	PRB25-6208-PA-ES	40	80	18	462	693	563	74.2	127.5
PRB25-6308-PA-GL	PRB25-6308-PA-ES	40	90	23	546	840	518	121.6	201.3
PRB25-16009-PA-GL	PRB25-16009-PA-ES	45	75	10	347	525	585	31.2	47.4
PRB25-6009-PA-GL	PRB25-6009-PA-ES	45	75	16	399	588	585	47.1	72.6
PRB25-6209-PA-GL	PRB25-6209-PA-ES	45	85	19	494	756	522	80.3	133.9
PRB25-6309-PA-GL	PRB25-6309-PA-ES	45	100	25	567	945	450	164.7	287.5
PRB25-6010-PA-GL	PRB25-6010-PA-ES	50	80	16	410	609	540	52.0	79.5
PRB25-6210-PA-GL	PRB25-6210-PA-ES	50	90	20	567	809	495	89.7	149.2

PRB30 塑料滚动轴承 Plastic ball bearings



PRB30系列塑料滚动轴承具有极好的机械强度和耐磨性能，此产品能在150度的高温下正常使用，并具有极好的抗腐蚀性几乎能在所有的腐蚀环境下运行；标准配置内外圈材料为：改良PEEK，保持架材料为：改良PEEK，滚珠材料为：陶瓷；长期连续使用温度-100~+150°C。

PRB30 series of plastic ball bearings has excellent mechanical strength and wear resistance, Max. operation temperature 250°C, these bearings has excellent corrosion resistance to almost all corrosive environment; The standard material of inner and outer ring: PEEK, cage material: PEEK, ball material: Ceramics; The long-term operation temperature: -100 ~ +150°C.

标准规格 Standard specifications

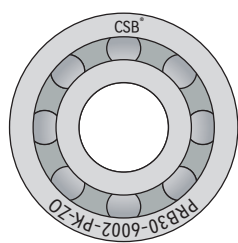
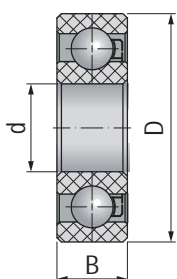

产品编码 Part No.:

PRB30-6002-PK-ZO

ZO: 陶瓷球 Ceramic balls
 ES: 不锈钢球 Stainless steel balls
 PK: PEEK保持架 Cage
 轴承规格 Specification
 型号 Type

产品编码 Part No.	产品编码 Part No.	d [mm]	D [mm]	B [mm]	极限静载荷 Max. static load [N]	极限动载荷 Max. dynamic load [N]	极限转速 Max. speed [RPM]	重量 Weight [g]	
								-ZO	-ES
PRB30-694-PK-ZO	PRB30-694-PK-ES	4	11	4	13	15	4400	0.3	0.4
PRB30-604-PK-ZO	PRB30-604-PK-ES	4	12	4	32	34	3960	0.5	0.7
PRB30-624-PK-ZO	PRB30-624-PK-ES	4	13	5	43	64	3960	0.7	0.9
PRB30-634-PK-ZO	PRB30-634-PK-ES	4	16	5	43	43	4070	1.0	1.5
PRB30-685-PK-ZO	PRB30-685-PK-ES	5	11	3	13	15	4400	0.4	0.5
PRB30-695-PK-ZO	PRB30-695-PK-ES	5	13	4	31	32	3850	0.5	0.7
PRB30-605-PK-ZO	PRB30-605-PK-ES	5	14	5	34	35	3850	0.8	1.0
PRB30-625-PK-ZO	PRB30-625-PK-ES	5	16	5	48	70	3355	1.0	1.4
PRB30-635-PK-ZO	PRB30-635-PK-ES	5	19	6	44	46	3520	1.7	2.6
PRB30-686-PK-ZO	PRB30-686-PK-ES	6	13	3.5	31	32	3850	0.6	0.8
PRB30-696-PK-ZO	PRB30-696-PK-ES	6	15	5	31	32	3850	0.9	1.1
PRB30-606-PK-ZO	PRB30-606-PK-ES	6	17	6	54	57	3630	1.3	1.5
PRB30-626-PK-ZO	PRB30-626-PK-ES	6	19	6	54	75	2860	1.7	2.8
PRB30-636-PK-ZO	PRB30-636-PK-ES	6	22	7	86	101	2420	2.6	4.0
PRB30-687-PK-ZO	PRB30-687-PK-ES	7	14	3.5	34	36	3520	0.6	0.8
PRB30-697-PK-ZO	PRB30-697-PK-ES	7	17	5	42	44	3300	1.1	1.5
PRB30-607-PK-ZO	PRB30-607-PK-ES	7	19	6	54	75	2860	1.5	2.2
PRB30-627-PK-ZO	PRB30-627-PK-ES	7	22	7	59	86	2420	2.5	3.9
PRB30-688-PK-ZO	PRB30-688-PK-ES	8	16	4	42	44	3300	2.5	3.9
PRB30-698-PK-ZO	PRB30-698-PK-ES	8	19	6	64	66	3520	1.5	2.3
PRB30-608-PK-ZO	PRB30-608-PK-ES	8	22	7	59	86	2420	2.3	3.6
PRB30-628-PK-ZO	PRB30-628-PK-ES	8	24	8	107	118	2530	3.3	5.5
PRB30-638-PK-ZO	PRB30-638-PK-ES	8	28	9	118	139	2420	5.5	7.7
PRB30-689-PK-ZO	PRB30-689-PK-ES	9	17	4	43	45	2750	0.9	1.3
PRB30-699-PK-ZO	PRB30-699-PK-ES	9	20	6	46	48	2475	1.6	2.1
PRB30-609-PK-ZO	PRB30-609-PK-ES	9	24	7	64	96	2255	6.4	7.7
PRB30-629-PK-ZO	PRB30-629-PK-ES	9	26	8	75	107	2090	4.0	6.2
PRB30-6800-PK-ZO	PRB30-6800-PK-ES	10	19	5	46	48	2475	1.6	2.1
PRB30-6900-PK-ZO	PRB30-6900-PK-ES	10	22	6	64	68	2200	1.9	3.3
PRB30-6000-PK-ZO	PRB30-6000-PK-ES	10	26	8	96	139	2090	4.0	6.1

产品编码 Part No.	产品编码 Part No.	d [mm]	D [mm]	B [mm]	极限静载荷 Max. static load [N]	极限动载荷 Max. dynamic load [N]	极限转速 Max. speed [RPM]	重量 Weight [g]	
								-ZO	-ES
PRB30-6200-PK-ZO	PRB30-6200-PK-ES	10	30	9	118	171	1815	6.3	8.8
PRB30-6300-PK-ZO	PRB30-6300-PK-ES	10	35	11	203	300	1540	11.0	17.2
PRB30-6801-PK-ZO	PRB30-6801-PK-ES	12	21	5	64	68	2200	1.4	1.8
PRB30-6901-PK-ZO	PRB30-6901-PK-ES	12	24	6	86	89	1980	2.0	3.1
PRB30-6001-PK-ZO	PRB30-6001-PK-ES	12	28	8	118	171	1925	4.5	7.0
PRB30-6201-PK-ZO	PRB30-6201-PK-ES	12	32	10	161	235	1705	7.5	11.8
PRB30-6301-PK-ZO	PRB30-6301-PK-ES	12	37	12	225	332	1430	13.0	21.6
PRB30-6802-PK-ZO	PRB30-6802-PK-ES	15	24	5	86	89	1980	1.5	2.5
PRB30-6902-PK-ZO	PRB30-6902-PK-ES	15	28	7	96	101	1870	3.0	4.4
PRB30-16002-PK-ZO	PRB30-16002-PK-ES	15	32	8	139	203	1650	5.3	7.9
PRB30-6002-PK-ZO	PRB30-6002-PK-ES	15	32	9	150	214	1650	6.2	9.0
PRB30-6202-PK-ZO	PRB30-6202-PK-ES	15	35	11	182	268	1540	9.1	14.2
PRB30-6302-PK-ZO	PRB30-6302-PK-ES	15	42	13	278	396	1320	17.0	27.0
PRB30-6803-PK-ZO	PRB30-6803-PK-ES	17	26	5	96	101	1870	1.6	2.8
PRB30-6903-PK-ZO	PRB30-6903-PK-ES	17	30	7	96	101	1870	0.8	1.4
PRB30-16003-PK-ZO	PRB30-16003-PK-ES	17	35	8	171	257	1540	6.4	9.5
PRB30-6003-PK-ZO	PRB30-6003-PK-ES	17	35	10	182	278	1540	8.1	11.3
PRB30-6203-PK-ZO	PRB30-6203-PK-ES	17	40	12	235	342	1375	13.5	18.9
PRB30-6303-PK-ZO	PRB30-6303-PK-ES	17	47	14	278	396	1155	23.8	37.1
PRB30-6804-PK-ZO	PRB30-6804-PK-ES	20	32	7	107	128	1650	3.5	5.1
PRB30-6904-PK-ZO	PRB30-6904-PK-ES	20	37	9	150	154	1265	6.6	9.7
PRB30-16004-PK-ZO	PRB30-16004-PK-ES	20	42	8	203	310	1265	9.5	13.7
PRB30-6004-PK-ZO	PRB30-6004-PK-ES	20	42	12	214	321	1265	13.8	20.5
PRB30-6204-PK-ZO	PRB30-6204-PK-ES	20	47	14	289	449	1155	21.4	33.1
PRB30-6304-PK-ZO	PRB30-6304-PK-ES	20	52	15	375	535	1045	30.7	48.1
PRB30-6805-PK-ZO	PRB30-6805-PK-ES	25	37	7	150	154	1265	4.1	6.4
PRB30-6905-PK-ZO	PRB30-6905-PK-ES	25	42	9	171	173	990	4.4	4.5
PRB30-16005-PK-ZO	PRB30-16005-PK-ES	25	47	8	225	332	1155	10.6	18.9
PRB30-6005-PK-ZO	PRB30-6005-PK-ES	25	47	12	257	385	1155	1.6	23.6
PRB30-6205-PK-ZO	PRB30-6205-PK-ES	25	52	15	342	514	1045	26.2	39.2
PRB30-6305-PK-ZO	PRB30-6305-PK-ES	25	62	17	428	642	798	48.0	75.6
PRB30-6806-PK-ZO	PRB30-6806-PK-ES	30	42	7	203	207	935	9.8	13.1
PRB30-6906-PK-ZO	PRB30-6906-PK-ES	30	47	9	407	428	1100	16.5	28.2
PRB30-16006-PK-ZO	PRB30-16006-PK-ES	30	55	9	257	396	990	16.8	25.9
PRB30-6006-PK-ZO	PRB30-6006-PK-ES	30	55	13	300	449	990	23.5	35.0
PRB30-6206-PK-ZO	PRB30-6206-PK-ES	30	62	16	385	589	880	40.4	62.8
PRB30-6306-PK-ZO	PRB30-6306-PK-ES	30	72	19	492	749	743	69.8	112.7
PRB30-16007-PK-ZO	PRB30-16007-PK-ES	35	62	9	289	439	880	21.1	32.0
PRB30-6007-PK-ZO	PRB30-6007-PK-ES	35	62	14	342	514	880	31.0	46.9
PRB30-6207-PK-ZO	PRB30-6207-PK-ES	35	72	17	439	663	770	58.5	94.0
PRB30-6307-PK-ZO	PRB30-6307-PK-ES	35	80	21	524	803	660	95.7	152.2
PRB30-16008-PK-ZO	PRB30-16008-PK-ES	40	68	9	321	482	825	28.4	37.3
PRB30-6008-PK-ZO	PRB30-6008-PK-ES	40	68	15	375	556	825	38.2	51.8
PRB30-6208-PK-ZO	PRB30-6208-PK-ES	40	80	18	471	706	688	77.4	130.1
PRB30-6308-PK-ZO	PRB30-6308-PK-ES	40	90	23	556	856	633	126.8	205.4
PRB30-16009-PK-ZO	PRB30-16009-PK-ES	45	75	10	353	535	715	32.6	48.4
PRB30-6009-PK-ZO	PRB30-6009-PK-ES	45	75	16	407	599	715	49.1	74.1
PRB30-6209-PK-ZO	PRB30-6209-PK-ES	45	85	19	503	770	638	83.7	136.6
PRB30-6309-PK-ZO	PRB30-6309-PK-ES	45	100	25	578	963	550	171.8	293.4
PRB30-6010-PK-ZO	PRB30-6010-PK-ES	50	80	16	417	621	660	54.2	81.2
PRB30-6210-PK-ZO	PRB30-6210-PK-ES	50	90	20	578	824	605	93.6	152.3

PRB40 塑料滚动轴承 Plastic ball bearings



PRB40系列塑料滚动轴承具有耐高低温、高承载以及更好的抗腐蚀性能；可应用在强酸、强碱、无机、有机盐、海水等领域。标准配置内外圈材料为：陶瓷，保持架材料为：改良PTFE或改良PEEK，滚珠材料为：陶瓷；长期使用温度-200 ~ +250°C。

PRB40 series of ceramic ball bearings can work under very high temperature and very low temperature. These bearings with high load and the best corrosion resistance; these bearings are good working under acid, alkaline, organic and inorganic salt as well as in sea water environments; The standard material of inner and outer ring: Ceramics, cage material: PTFE or PEEK, ball material: Ceramics; The long-term operation temperature: -200 ~ +250°C.

标准规格 Standard specifications

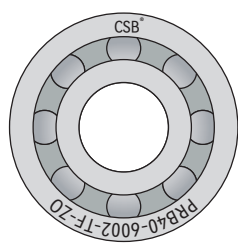
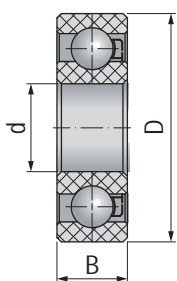

产品编码 Part No.:

PRB40-6002-TF-ZO

ZO: 陶瓷球 Ceramic balls

TF: PTFE保持架 Cage

PK: PEEK保持架 Cage

轴承规格 Specification

型号 Type

产品编码 Part No.	产品编码 Part No.	d [mm]	D [mm]	B [mm]	极限静载荷 Max. static load [N]	极限动载荷 Max. dynamic load [N]	极限转速 Max. speed [RPM]	重量 Weight [g]	
								-TF	-PK
PRB40-694-TF-ZO	PRB40-694-PK-ZO	4	11	4	24	28	6400	1.3	1.3
PRB40-604-TF-ZO	PRB40-604-PK-ZO	4	12	4	60	64	5760	1.7	1.7
PRB40-624-TF-ZO	PRB40-624-PK-ZO	4	13	5	80	120	5760	2.3	2.3
PRB40-634-TF-ZO	PRB40-634-PK-ZO	4	16	5	80	80	5920	4	4
PRB40-685-TF-ZO	PRB40-685-PK-ZO	5	11	3	24	28	6400	0.9	0.9
PRB40-695-TF-ZO	PRB40-695-PK-ZO	5	13	4	58	60	5600	1.9	1.9
PRB40-605-TF-ZO	PRB40-605-PK-ZO	5	14	5	64	66	5600	2.7	2.7
PRB40-625-TF-ZO	PRB40-625-PK-ZO	5	16	5	90	130	4880	3.8	3.8
PRB40-635-TF-ZO	PRB40-635-PK-ZO	5	19	6	82	86	5120	6.6	6.6
PRB40-686-TF-ZO	PRB40-686-PK-ZO	6	13	3.5	58	60	5600	1.5	1.5
PRB40-696-TF-ZO	PRB40-696-PK-ZO	6	15	5	58	60	5600	3	3
PRB40-606-TF-ZO	PRB40-606-PK-ZO	6	17	6	100	106	5280	4.6	4.6
PRB40-626-TF-ZO	PRB40-626-PK-ZO	6	19	6	100	140	4160	6.3	6.3
PRB40-636-TF-ZO	PRB40-636-PK-ZO	6	22	7	160	188	3520	10.8	10.8
PRB40-687-TF-ZO	PRB40-687-PK-ZO	7	14	3.5	64	68	5120	1.7	1.7
PRB40-697-TF-ZO	PRB40-697-PK-ZO	7	17	5	78	82	4800	4	4
PRB40-607-TF-ZO	PRB40-607-PK-ZO	7	19	6	100	140	4160	5.9	5.9
PRB40-627-TF-ZO	PRB40-627-PK-ZO	7	22	7	110	160	3520	9.8	9.8
PRB40-688-TF-ZO	PRB40-688-PK-ZO	8	16	4	78	82	4800	2.5	2.5
PRB40-698-TF-ZO	PRB40-698-PK-ZO	8	19	6	120	124	5120	5.6	5.6
PRB40-608-TF-ZO	PRB40-608-PK-ZO	8	22	7	110	160	3520	9.3	9.3
PRB40-628-TF-ZO	PRB40-628-PK-ZO	8	24	8	200	220	3680	13	13
PRB40-638-TF-ZO	PRB40-638-PK-ZO	8	28	9	220	260	3520	22	22
PRB40-689-TF-ZO	PRB40-689-PK-ZO	9	17	4	80	84	4000	2.7	2.7
PRB40-699-TF-ZO	PRB40-699-PK-ZO	9	20	6	86	90	3600	6.5	6.5
PRB40-609-TF-ZO	PRB40-609-PK-ZO	9	24	7	120	180	3280	11	11
PRB40-629-TF-ZO	PRB40-629-PK-ZO	9	26	8	140	200	3040	15	15
PRB40-6800-TF-ZO	PRB40-6800-PK-ZO	10	19	5	86	90	3600	4	4
PRB40-6900-TF-ZO	PRB40-6900-PK-ZO	10	22	6	120	128	3200	7	7
PRB40-6000-TF-ZO	PRB40-6000-PK-ZO	10	26	8	180	260	3040	14	14

产品编码 Part No.	产品编码 Part No.	d [mm]	D [mm]	B [mm]	极限静载荷 Max. static load [N]	极限动载荷 Max. dynamic load [N]	极限转速 Max. speed [RPM]	重量 Weight [g]	
								-TF	-PK
PRB40-6200-TF-ZO	PRB40-6200-PK-ZO	10	30	9	220	320	2640	25	25
PRB40-6300-TF-ZO	PRB40-6300-PK-ZO	10	35	11	380	560	2240	40	40
PRB40-6801-TF-ZO	PRB40-6801-PK-ZO	12	21	5	120	128	3200	5	5
PRB40-6901-TF-ZO	PRB40-6901-PK-ZO	12	24	6	160	166	2880	8	8
PRB40-6001-TF-ZO	PRB40-6001-PK-ZO	12	28	8	220	320	2800	17	17
PRB40-6201-TF-ZO	PRB40-6201-PK-ZO	12	32	10	300	440	2480	28	28
PRB40-6301-TF-ZO	PRB40-6301-PK-ZO	12	37	12	420	620	2080	46	46
PRB40-6802-TF-ZO	PRB40-6802-PK-ZO	15	24	5	160	166	2880	5	5
PRB40-6902-TF-ZO	PRB40-6902-PK-ZO	15	28	7	180	188	2720	12	12
PRB40-16002-TF-ZO	PRB40-16002-PK-ZO	15	32	8	260	380	2400	21	21
PRB40-6002-TF-ZO	PRB40-6002-PK-ZO	15	32	9	280	400	2400	24	24
PRB40-6202-TF-ZO	PRB40-6202-PK-ZO	15	35	11	340	500	2240	35	35
PRB40-6302-TF-ZO	PRB40-6302-PK-ZO	15	42	13	520	740	1920	64	64
PRB40-6803-TF-ZO	PRB40-6803-PK-ZO	17	26	5	180	188	2720	5	5
PRB40-6903-TF-ZO	PRB40-6903-PK-ZO	17	30	7	180	188	2720	13	13
PRB40-16003-TF-ZO	PRB40-16003-PK-ZO	17	35	8	320	480	2240	25	25
PRB40-6003-TF-ZO	PRB40-6003-PK-ZO	17	35	10	340	520	2240	32	32
PRB40-6203-TF-ZO	PRB40-6203-PK-ZO	17	40	12	440	640	2000	52	52
PRB40-6303-TF-ZO	PRB40-6303-PK-ZO	17	47	14	520	740	1680	87	87
PRB40-6804-TF-ZO	PRB40-6804-PK-ZO	20	32	7	200	240	2400	13	13
PRB40-6904-TF-ZO	PRB40-6904-PK-ZO	20	37	9	280	288	1840	28	28
PRB40-16004-TF-ZO	PRB40-16004-PK-ZO	20	42	8	380	580	1840	37	37
PRB40-6004-TF-ZO	PRB40-6004-PK-ZO	20	42	12	400	600	1840	52	52
PRB40-6204-TF-ZO	PRB40-6204-PK-ZO	20	47	14	540	840	1680	82	82
PRB40-6304-TF-ZO	PRB40-6304-PK-ZO	20	52	15	700	1000	1520	110	110
PRB40-6805-TF-ZO	PRB40-6805-PK-ZO	25	37	7	280	288	1840	16	16
PRB40-6905-TF-ZO	PRB40-6905-PK-ZO	25	42	9	320	324	1440	32	32
PRB40-16005-TF-ZO	PRB40-16005-PK-ZO	25	47	8	420	620	1680	45	45
PRB40-6005-TF-ZO	PRB40-6005-PK-ZO	25	47	12	480	720	1680	61	61
PRB40-6205-TF-ZO	PRB40-6205-PK-ZO	25	52	15	640	960	1520	99	99
PRB40-6305-TF-ZO	PRB40-6305-PK-ZO	25	62	17	800	1200	1160	180	180
PRB40-6806-TF-ZO	PRB40-6806-PK-ZO	30	42	7	380	386	1360	18	18
PRB40-6906-TF-ZO	PRB40-6906-PK-ZO	30	47	9	760	800	1600	40	40
PRB40-16006-TF-ZO	PRB40-16006-PK-ZO	30	55	9	480	740	1440	67	67
PRB40-6006-TF-ZO	PRB40-6006-PK-ZO	30	55	13	560	840	1440	89	89
PRB40-6206-TF-ZO	PRB40-6206-PK-ZO	30	62	16	720	1100	1280	150	150
PRB40-6306-TF-ZO	PRB40-6306-PK-ZO	30	72	19	920	1400	1080	270	270
PRB40-16007-TF-ZO	PRB40-16007-PK-ZO	35	62	9	540	820	1280	82	82
PRB40-6007-TF-ZO	PRB40-6007-PK-ZO	35	62	14	640	960	1280	120	120
PRB40-6207-TF-ZO	PRB40-6207-PK-ZO	35	72	17	820	1240	1120	220	220
PRB40-6307-TF-ZO	PRB40-6307-PK-ZO	35	80	21	980	1500	960	360	360
PRB40-16008-TF-ZO	PRB40-16008-PK-ZO	40	68	9	600	900	1200	100	100
PRB40-6008-TF-ZO	PRB40-6008-PK-ZO	40	68	15	700	1040	1200	150	150
PRB40-6208-TF-ZO	PRB40-6208-PK-ZO	40	80	18	880	1320	1000	280	280
PRB40-6308-TF-ZO	PRB40-6308-PK-ZO	40	90	23	1040	1600	920	490	490
PRB40-16009-TF-ZO	PRB40-16009-PK-ZO	45	75	10	660	1000	1040	130	130
PRB40-6009-TF-ZO	PRB40-6009-PK-ZO	45	75	16	760	1120	1040	190	190
PRB40-6209-TF-ZO	PRB40-6209-PK-ZO	45	85	19	940	1440	928	320	320
PRB40-6309-TF-ZO	PRB40-6309-PK-ZO	45	100	25	1080	1800	800	640	640
PRB40-6010-TF-ZO	PRB40-6010-PK-ZO	50	80	16	780	1160	960	200	200
PRB40-6210-TF-ZO	PRB40-6210-PK-ZO	50	90	20	1080	1540	880	350	350

PRTB10 塑料滚动推力轴承 Plastic ball thrust bearings



PRTB10作为通用性更强的塑料滚动轴承材料具有良好的强度和耐磨性，由于其材料自身的润滑性噪音较低；此类轴承碱性环境下表现良好但不适合在酸性环境下长期运行。标准配置内外圈材料为：改良POM，滚珠材料为：玻璃球或不锈钢（选配）；长期连续使用温度-40 ~ +80°C。

PRTB10 has good strength and wear resistance as a generic plastic ball bearings, the operation noise very low because the self-lubrication of the material; These bearings perform well in an alkaline environment but not for long-term operation in an acidic environment. The standard material of inner and outer ring: POM, ball material: glass or stainless steel; The long-term operation temperature: -40 ~ +80°C.

标准规格 Standard specifications

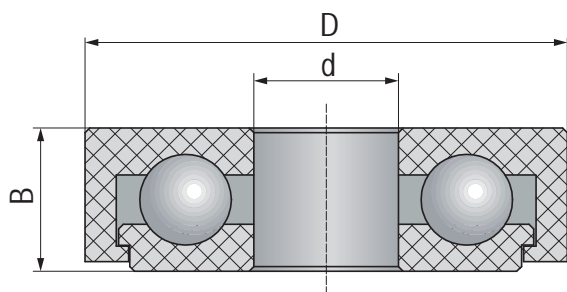

产品编码 Part No.:

PRTB10-51100-GL

GL: 玻璃球 Glass balls

ES: 不锈钢球 Stainless steel balls

轴承规格 Specification

型号 Type

产品编码 Part No.	产品编码 Part No.	d [mm]	D [mm]	B [mm]	极限静载荷 Max. static load [N]	极限动载荷 Max. dynamic load [N]	极限转速 Max. speed [RPM]	重量 Weight [g]	
								-GL	-ES
PRTB10-51100-GL	PRTB10-51100-ES	10	24	9	200	250	600	4.0	5.2
PRTB10-51200-GL	PRTB10-51200-ES	10	26	11	210	260	600	6.1	7.9
PRTB10-51101-GL	PRTB10-51101-ES	12	26	9	320	400	540	4.4	5.6
PRTB10-51201-GL	PRTB10-51201-ES	12	28	11	330	410	540	7.2	9.5
PRTB10-51102-GL	PRTB10-51102-ES	15	28	9	500	625	500	4.7	6.1
PRTB10-51202-GL	PRTB10-51202-ES	15	32	12	520	650	500	9.3	11.5
PRTB10-51103-GL	PRTB10-51103-ES	17	30	9	570	710	480	5.2	6.8
PRTB10-51203-GL	PRTB10-51203-ES	17	35	12	600	750	480	10.7	14.9
PRTB10-51104-GL	PRTB10-51104-ES	20	35	10	650	810	460	7.6	10.3
PRTB10-51204-GL	PRTB10-51204-ES	20	40	14	690	860	460	15.7	20.5
PRTB10-51105-GL	PRTB10-51105-ES	25	42	11	710	880	410	11.3	14.6
PRTB10-51205-GL	PRTB10-51205-ES	25	47	15	750	930	400	22.2	26.5
PRTB10-51106-GL	PRTB10-51106-ES	30	47	11	760	950	400	13.4	17.3
PRTB10-51206-GL	PRTB10-51206-ES	30	52	16	820	1025	375	26.9	34
PRTB10-51107-GL	PRTB10-51107-ES	35	52	12	810	1010	390	16.6	20.8
PRTB10-51207-GL	PRTB10-51207-ES	35	62	18	870	1090	365	44.3	56.9
PRTB10-51108-GL	PRTB10-51108-ES	40	60	13	890	1110	375	24.7	31.2
PRTB10-51208-GL	PRTB10-51208-ES	40	68	19	940	1175	350	53.1	67.1
PRTB10-51109-GL	PRTB10-51109-ES	45	65	14	950	1185	360	28.2	37.5
PRTB10-51209-GL	PRTB10-51209-ES	45	73	20	1010	1260	330	62.1	86.7
PRTB10-51110-GL	PRTB10-51110-ES	50	70	14	1020	1275	340	30.5	40.5
PRTB10-51210-GL	PRTB10-51210-ES	50	78	22	1100	1375	310	80.4	107

BTU 万向滚珠轴承 Ball transfer units



塑料万向滚珠轴承与钢制轴承相比具有不导电、耐酸碱液、无需润滑、免维护、低摩擦、重量轻（最多可减少70%）、适用于真空或压力、盐水-证明，根据材料选择不含金属成分，运输玻璃等易碎物品，可用于爆炸性环境和无菌区域（例如医疗技术），可定制设计。

In comparison to steel units, ball transfer units out of plastics are non-conductive, resistant to acid and lye, no lubrication, maintenance-free low friction, low weight (up to 70% less), appropriate for vacuum or pressure, saltwater-proof, free of metallic components depending on selection of materials, transport of fragile goods such as glass, available use in explosive atmosphere and aseptic areas (e.g. medical technology), customized design possible.

标准规格 Standard specifications

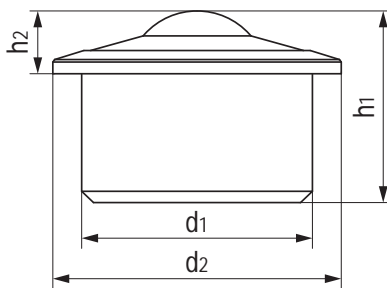

产品编码 Part No.:

BTU508-PM-ES-PM

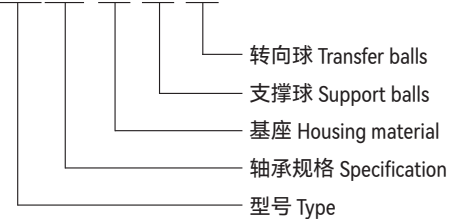

产品编码 Part No.	d ₁ [mm]	d ₁ 公差 Tolerance [mm]	d ₂ ±0.10 [mm]	h ₁ [mm]	h ₂ ±0.20 [mm]	*最大轴承静态载荷 Max. axial static load [N]
BTU508-PM-ES-PM	15	±0.04	20	11.1	4.3	45
BTU512-PM-ES-PM	18	±0.04	23	15.5	7.3	55
BTU515-PM-ES-PM	24	±0.06	31	21	9.8	70
BTU519-PM-ES-PM	30	±0.06	37	26	9.8	85
BTU522-PM-ES-PM	36	±0.08	45	30	9.8	100
BTU525-PM-ES-PM	38	±0.08	45	31	13.8	120
BTU530-PM-ES-PM	45	±0.08	55	37	13.8	150
BTU538-PM-ES-PM	55	±0.08	65	48	16	175
BTU545-PM-ES-PM	62	±0.10	75	53.5	19	200
BTU560-PM-ES-PM	100	±0.10	117	78	30	300

*轴承载荷特性取决于材料配置 Max. static load depending on selection of materials

BTU万向滚珠轴承可选配置表 Ball transfer unit optional materials

基座 Housing			转向球 Transfer balls			支撑球 Support balls		
PM	POM	标准材料 Standard materials -40/+90°C	PM	POM	标准材料 Standard materials -40/+90°C	PM	POM	无磁性与重量轻 Non-magnetic and lightweight -40/+90°C
PK	PEEK	高强度与耐腐蚀 High-load&Anti-corrosion -100/+250°C	ES	Stainless steel	高载荷 High-load	ES	Stainless steel	标准材料 Standard materials
PT	PET	医疗辐射 Medical radiation -40/+100°C	ZO	Ceramic	高强度与耐腐蚀 High-load&Anti-corrosion -200/+400°C	ZO	Ceramic	高强度与耐腐蚀 High-load&Anti-corrosion -200/+400°C
PS	PPS	高强度与耐腐蚀 High-load&Anti-corrosion -40/+200°C	PK	PEEK	高强度与耐腐蚀 High-load&Anti-corrosion -100/+250°C	PK	PEEK	高强度与耐腐蚀 High-load&Anti-corrosion -100/+250°C
PF	PVDF	真空应用 Vacuum applications -50/+150°C	GL	Glass	重量轻与低成本 Lightweight and low cost -200/+400°C	GL	Glass	重量轻与低成本 Lightweight and low cost -200/+400°C

GBB-BB基座滚动轴承 Pillow block ball bearings



产品特性 Product features

- 干运行、免维护
 - 补偿中心误差
 - 耐腐蚀，可用于液体介质环境
 - 顺畅运行，无噪音
 - 长期使用温度：-40°C-80°C
 - 基座高强度材料：CSB® M163
 - 轴承材料：环-POM，保持架-PA，球-不锈钢或玻璃
- Dry operation and maintenance-free
 - Compensation of misalignment errors
 - Absolute corrosion resistance
 - Smooth running and no noise
 - Long-term application temperature: -40°C-80°C
 - Housing high-strength material: CSB® M163
 - Bearing material: Rings-POM, Cage-PA, Balls-Stainless steel or glass

标准规格 Standard specifications

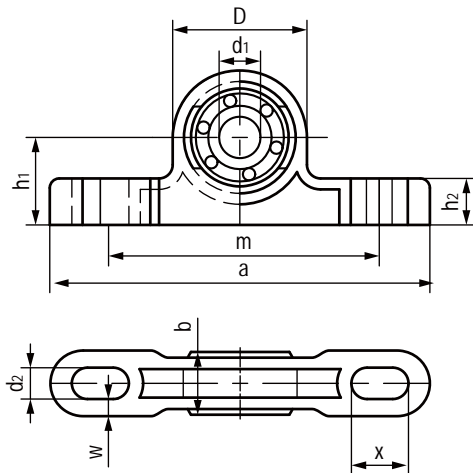

产品编码 Part No.:

GBB-BB-P08-POM-PA-ES

- GL: 玻璃球 Glass balls
- ES: 不锈钢球 Stainless steel balls
- 保持架材料 Cage material
- 外圈材料 Outer ring material
- 内径 Inner diameter
- 滚动轴承 Ball bearing

产品编码 Part No.	d ₁ E10 [mm]	d ₂ [mm]	h ₁ [mm]	h ₂ [mm]	D [mm]	b [mm]	a [mm]	m [mm]	x [mm]	w [mm]	最大载荷 Max. capacity load		最大速度 Max. speed [RPM]	最大 调节角度 Max. pivot angle	重量 Weight [g]
											静态 Static [N]	动态 Dynamic [N]			
GBB-BB-P08-POM-PA-ES	08	6.6	18	10.5	SD31.7	13	86	60	12	4.2	80	94	2200	5.0°	21.8
GBB-BB-P10-POM-PA-ES	10	9	22	13	SD38	16	98	68	14	4.5	110	130	1900	5.0°	29.6
GBB-BB-P12-POM-PA-ES	12	9	27	16	SD46.7	20	124	86	17	6.5	130	147	2000	5.0°	49.1
GBB-BB-P08-POM-PA-GL	08	6.6	18	10.5	SD31.7	13	86	60	12	4.2	80	94	2200	5.0°	19.6
GBB-BB-P10-POM-PA-GL	10	9	22	13	SD38	16	98	68	14	4.5	110	130	1900	5.0°	27.4
GBB-BB-P12-POM-PA-GL	12	9	27	16	SD46.7	20	124	86	17	6.5	130	147	2000	5.0°	46.9

GFB-BB法兰滚动轴承 Flange ball bearings



产品特性 Product features

- 干运行、免维护
 - 补偿中心误差
 - 耐腐蚀，可用于液体介质环境
 - 顺畅运行，无噪音
 - 长期使用温度：-40°C-80°C
 - 基座高强度材料：CSB® M163
 - 轴承材料：环-POM，保持架-PA，球-不锈钢或玻璃
- Dry operation and maintenance-free
 - Compensation of misalignment errors
 - Absolute corrosion resistance
 - Smooth running and no noise
 - Long-term application temperature: -40°C-80°C
 - Housing high-strength material: CSB® M163
 - Bearing material: Rings-POM, Cage-PA, Balls-Stainless steel or glass

标准规格 Standard specifications

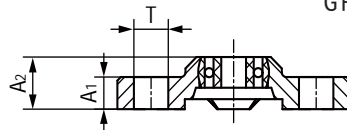
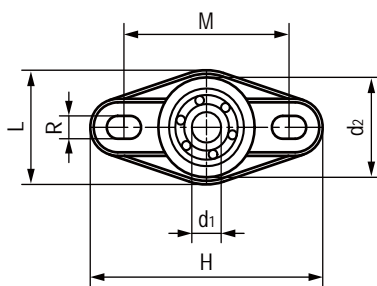

产品编码 Part No.:

GFB-BB-P08-POM-PA-ES

- GL: 玻璃球 Glass balls
- ES: 不锈钢球 Stainless steel balls
- 保持架材料 Cage material
- 外圈材料 Outer ring material
- 内径 Inner diameter
- 滚动轴承 Ball bearing

产品编码 Part No.	d ₁ E10 [mm]	d ₂ [mm]	A ₁ [mm]	A ₂ [mm]	T [mm]	L [mm]	H [mm]	Z [mm]	M [mm]	最大载荷 Max. capacity load		最大速度 Max. speed [RPM]	最大 调节角度 Max. pivot angle	重量 Weight [g]
										静态 Static [N]	动态 Dynamic [N]			
GFB-BB-P08-POM-PA-ES	08	32	10	17.5	10.1	38	72.6	6.4	53	80	94	2200	5.0°	22.9
GFB-BB-P10-POM-PA-ES	10	40	11	20	12.5	47	89	8.4	65	110	130	1900	5.0°	35.8
GFB-BB-P12-POM-PA-ES	12	48.5	14	25	12.6	58.5	101	8.4	75	130	147	2000	5.0°	57.5
GFB-BB-P08-POM-PA-GL	08	32	10	17.5	10.1	38	72.6	6.4	53	80	94	2200	5.0°	20.7
GFB-BB-P10-POM-PA-GL	10	40	11	20	12.5	47	89	8.4	65	110	130	1900	5.0°	33.6
GFB-BB-P12-POM-PA-GL	12	48.5	14	25	12.6	58.5	101	8.4	75	130	147	2000	5.0°	55.4

GSB-BB方法兰滚动轴承 Flange ball bearings



产品特性 Product features

- 干运行、免维护
 - 补偿中心误差
 - 耐腐蚀，可用于液体介质环境
 - 顺畅运行，无噪音
 - 长期使用温度：-40°C-80°C
 - 基座高强度材料：CSB® M163
 - 轴承材料：环-POM，保持架-PA，球-不锈钢或玻璃
- Dry operation and maintenance-free
 - Compensation of misalignment errors
 - Absolute corrosion resistance
 - Smooth running and no noise
 - Long-term application temperature: -40°C-80°C
 - Housing high-strength material: CSB® M163
 - Bearing material: Rings-POM, Cage-PA, Balls-Stainless steel or glass

标准规格 Standard specifications

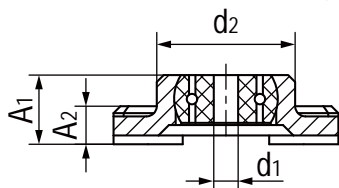
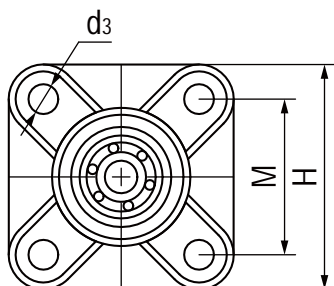

产品编码 Part No.:

GSB-BB-P08-POM-PA-ES

- GL: 玻璃球 Glass balls
- ES: 不锈钢球 Stainless steel balls
- 保持架材料 Cage material
- 外圈材料 Outer ring material
- 内径 Inner diameter
- 滚动轴承 Ball bearing

产品编码 Part No.	d ₁ E10 [mm]	d ₂ [mm]	d ₃ [mm]	A ₁ [mm]	A ₂ [mm]	M [mm]	H [mm]	最大载荷 Max. capacity load		最大速度 Max. speed [RPM]	最大 调节角度 Max. pivot angle	重量 Weight [g]
								静态 Static [N]	动态 Dynamic [N]			
GSB-BB-P08-POM-PA-ES	08	32	6.4	16.5	9	36	52	80	94	2200	5.0°	28.1
GSB-BB-P10-POM-PA-ES	10	40	8.4	20	11	45	65	110	130	1900	5.0°	48.1
GSB-BB-P12-POM-PA-ES	12	48.5	8.4	25	14	52	74	130	147	2000	5.0°	74.7
GSB-BB-P08-POM-PA-GL	08	32	6.4	16.5	9	36	52	80	94	2200	5.0°	25.9
GSB-BB-P10-POM-PA-GL	10	40	8.4	20	11	45	65	110	130	1900	5.0°	46.1
GSB-BB-P12-POM-PA-GL	12	48.5	8.4	25	14	52	74	130	147	2000	5.0°	72.5