

CSB-EPB[®] Technical Information

CSB-EPB[®] 工程塑料轴承技术信息

CSB-EPB[®] 材料结构特点 Material features

CSB-EPB[®] 材料之所以具有优秀的自润滑性和耐磨性主要是CSB工程师们充分利用了自润滑材料改性技术，在高性能工程塑料中采用高强度纤维提高了材料的承载和特种润滑脂降低了材料的摩擦系数（图表1），从而提高了材料的综合耐磨性能延长了轴承的使用寿命。

高性能工程塑料作为基料主要作为耐磨载体；
增强纤维提高了轴承在承载和抗冲击性能；
特种润滑脂降低了轴承的摩擦系数起自润滑作用。

CSB engineers are dedicated on the performance improvement on the self-lubricating materials derives the result that CSB-EPB[®] Materials are

with excellent self-lubricating features and wear resistance Features. High-strength fibers used in the engineering plastics fantastically improve the material load (Graph 1). Special grease immersion in the plastic can decrease the friction coefficient of the material therefore to prolong the bearing service life.

High-performance engineering plastics body material mainly service as wear-resistant vector.

The reinforced fiber improves the load and impact resistant capacity of the bearing.

Special grease decreases the friction coefficient for a better self-lubricating performance.

图表1 CSB-EPB[®] 材料内部结构示意图
Graph 1 CSB-EPB[®] materials structure

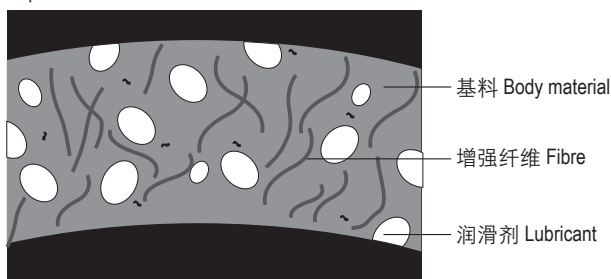

图表2 塑料轴承与传统含油轴承的磨损
Graph 2 Surface wear (Plastic bearings and metal bearings)

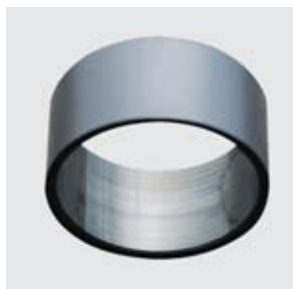

CSB-EPB[®] 塑料轴承整体润滑材料使用寿命长
CSB-EPB[®] plastic plain bearings has longer service life.



传统含油轴承内部润滑油极易耗尽而失效
Lubricating oil in metal bearings easily depleted and fail.

CSB-EPB[®] 塑料轴承与传统含油轴承 Plastic bearings and metal bearings

由于CSB-EPB[®]塑料轴承润滑脂包含在整体材料中，所以无论轴承工作时间多长润滑脂都会不断的从摩擦面渗出起到长期润滑作用，而传统粉末冶金含油轴承在使用过程中利用微孔隙中的润滑油起自润滑作用，当这些润滑油耗尽或挥发完后轴承磨损将急速加剧，此时就宣告轴承的有效使用寿命结束（图表2）。

Because the grease immersed in the solid plastic material, the lubricating will be valid continuously no matter how long the bearings are working. Therefore, the traditional sintered oilless bearings provide the lubricating function by utilizing the impregnated oil in the tiny porosities of the material. When the impregnated oil would have been run out of dried, the bearing wear will be increased sharply and the bearing life will be terminated at the same time. (Graph 2).

CSB-EPB® 塑料轴承摩擦系数 Bearing friction coefficient

CSB-EPB®塑料轴承的自润滑性能通过改性技术在基料中添加固体润滑脂和功能纤维实现，摩擦系数通过固体润滑脂降低，同时摩擦系数还受到工作载荷、运行速度以及轴表面粗糙度的影响。摩擦系数一般都会随着工作载荷的逐步增加而降低，随着运行速度的加快而升高（见图表3）。摩擦系数与轴表面粗糙度的关系见图表3。

The self-lubricating feature of the CSB-EPB® plastic bearing is achieved by adding solid lubricants and functional fibers into the body material and the friction coefficient is decreased by the solid lubricate grease immersion. The friction coefficient is affected by the load, operating speed and shaft roughness. The friction coefficient is generally decreased along the load increasing and increased along the operating speed (see Graph3). Please refer to Graph 3 for the relation between the friction coefficient and shaft roughness.

图表3: 摩擦系数-载荷-速度
Graph 3: Friction coefficient, Load and Velocity

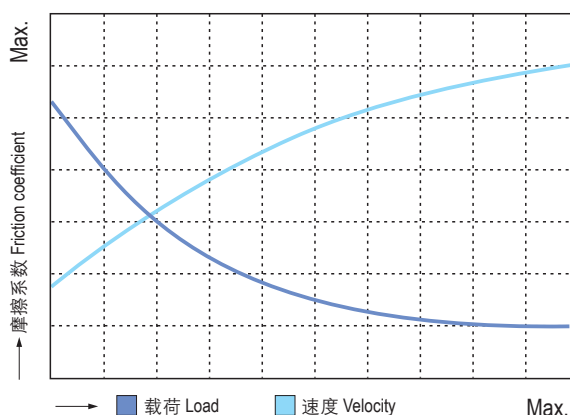

CSB-EPB® 塑料轴承磨损 Plastic bearing wear

任何自润滑轴承在载荷下工作初始阶段，轴承就会产生细微磨损。CSB-EPB®塑料轴承同样如此，在启动阶段，当细微磨损发生时润滑脂就会渗出逐渐填满摩擦面和转移到对磨轴表面（图表4），当对磨轴工作区域被润滑脂布满后便形成一层很薄的润滑隔离膜，此时轴承的起始磨损几乎结束，在后长期时间的工作中轴承的磨损速率大大降低且较稳定（图表5）。

Slightly wear off will occur as soon as the self-lubricating bearing is applied with a certain load. It is the same to the CSB-EPB® plastic bearings, when the slightly wear occurs, the immersed oil (grease) will infiltrate out from the bearing filling the wear off area of the bearing as well as the mating material to form the lubricating film (Graph 4) and therefore interrupt the wear process. In this way, the aforementioned working method of the plastic bearings improves the wear resistance feature of the bearings and maintains the further operation stable (Graph 5).

图表4 运行后，润滑膜形成
Graph 4 After operation, lubricating oil film formed

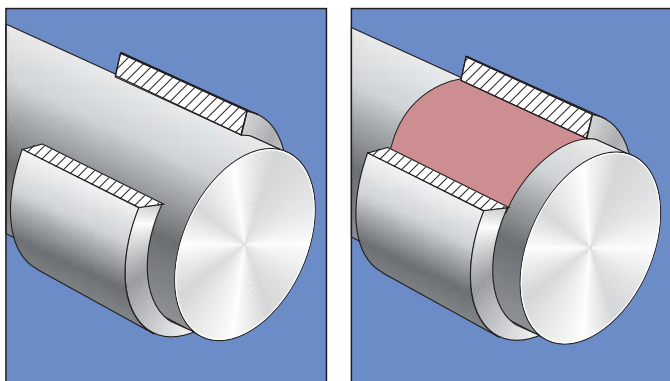

图表5 轴承磨损随工作时间变化曲线图
Graph 5 Wear against operation time

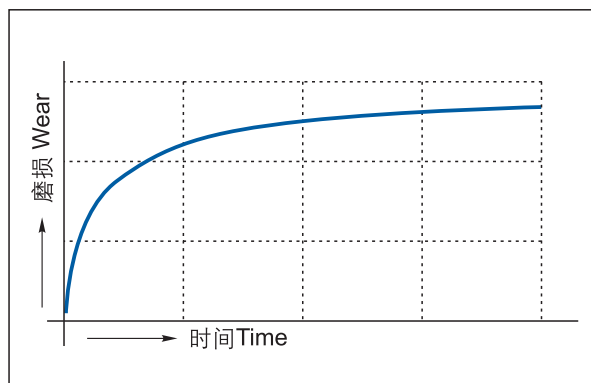

CSB-EPB[®] Technical Information

CSB-EPB[®] 工程塑料轴承技术信息

轴承的载荷 Bearing load

■ 载荷计算方法 Load capacity calculation

◇ 直套、翻边产品 Cylindrical bushes, flange bushes

$$P = \frac{F}{d \times L} \quad (\text{N/mm}^2)$$

F=轴承承载值 Load (N)
d=轴径 Shaft (mm)
L=轴承长度 Bearing Length (mm)

◇ 止推垫片 Thrust washer

$$P = \frac{4F}{\pi (D^2 - d^2)} \quad (\text{N/mm}^2)$$

F=垫片承载值 Load (N)
D=垫片外径 Washer OD (mm)
d=垫片内径 Washer ID (mm)

由于受配合间隙、材料强度、内部油槽等原因的影响，轴承的真正承载面压 (P_{act}) 会大于理论计算值 (P_{mean})。

■ 最大载荷 Maximum load

塑料轴承实际工作最大动载荷往往小于数据表中推荐最大静载荷 (图表6)，由于轴与轴承属于间隙配合，所以轴承实际工作承载面积并不是轴承的投影面积，此面积的大小由配合轴尺寸公差所决定。最大静载荷适用于轴静止不动 (参照CSB测试标准ITS027)，最大动载荷适用于低速运行工况 (参照CSB测试标准ITS028)，比轴承最大动载荷更高的动载荷允许在短时间内运行 (短时间指连续允许3分钟以内)。

The actual dynamic load is usually less than the maximum static load recommended in the data sheet (Graph 6). Due to the clearance exists between the shaft and inner diameter of the plastic plain bearings, the actual working surface area are less than the projected area of the plastic plain bearings. The working area is depended on the clearance between the shaft and the bearings. The maximum static load under the shaft is static(according CSB test standard ITS027), The maximum dynamic load is suitable for low speed(according CSB test standard ITS028). Higher dynamic load than the maximum dynamic load could also be applicable for a short-term operation condition (shorter than 3 minutes).

■ 最大静载荷 Maximum static load
■ 最大动载荷 Maximum dynamic load

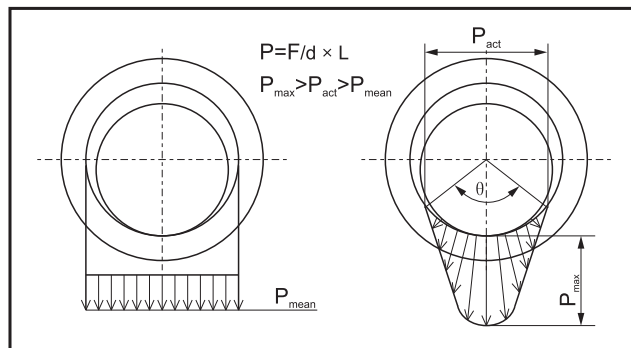

As the factor of clearance, bushes chamfer, oil groove ect., The actually load (P_{act}) is higher than theory of calculation (P_{mean}).

图表6: CSB-EPB[®] 塑料轴承最大载荷分布图
Graph 6: Max. load of plastic plain bearings

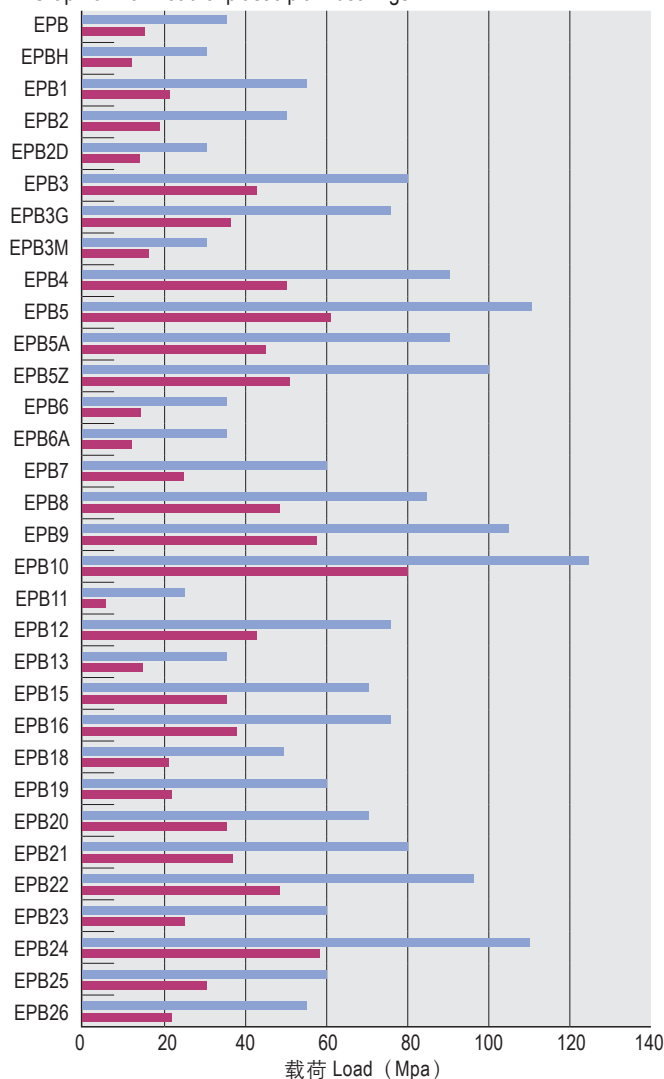

■ 载荷与温度、速度的关系 Load, temperature and speed

轴承的载荷会随着轴承工作温度的升高而逐步降低，当运行温度超过最大使用温度后轴承的承载能力会急剧下降（图表7）。

轴承的载荷会随着轴承运行速度的加快而逐步降低，当运行速度加快后会导致轴承的摩擦温度逐步上升，而载荷会随着轴承温度的不断上升而逐渐降低。

The load capacity will be decreased along with the temperature increase. Load capacity may sharply decrease when the operating temperature is higher than the recommended maximum temperature (Graph 7).

The load capacity will be decreased along with the speed increase. Speed increase will result into a temperature increase that decreases the load capacity.

图表7: 载荷随温度变化曲线图

Graph 7: Load and Temperature

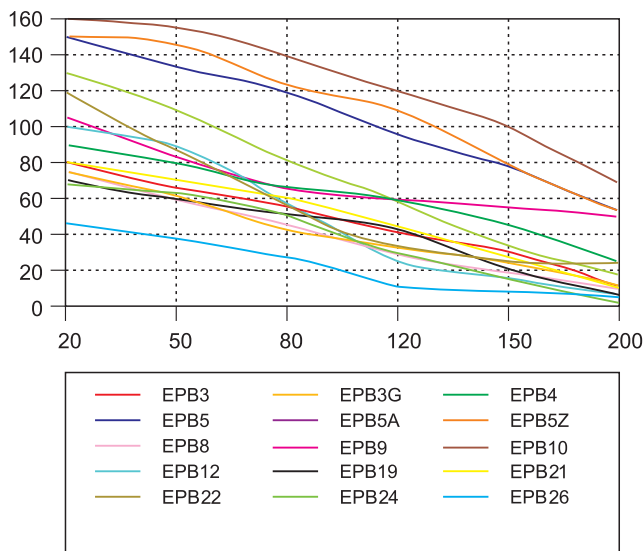
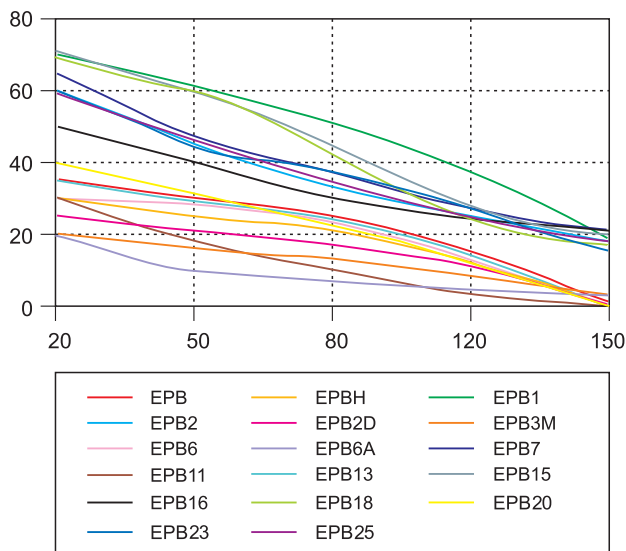

对于滑动轴承来说，运行速度是个关键性参数，由于滑动轴承工作时与轴之间发生的是相对滑动摩擦而不是滚动摩擦，所以最大运行速度滑动轴承要远低于滚动轴承。这里所说的速度是指轴与轴承之间运行的相对线速度而不是转速。

The operating speed is one of the key parameters for the sliding bearings. The friction between the sliding bearing and the shaft is a linear friction. So the operating speed of sliding bearing is much less than that of a rolling bearing where the friction is a rotation method. The speed here is the relative linear speed between the bearing and the shaft but not a rotation speed.

■ 线速度计算公式 Speed calculation

◇ 旋转运动 Rotating motion

$$V = \frac{\pi \times d \times n}{1000 \times 60} \text{ (m/s)}$$

d=轴径 Shaft (mm)
n=转数/分 Rpm

◇ 摇摆运动 Oscillating motion

$$V = \frac{\pi \times d \times C \times \theta}{1000 \times 360 \times 60} \text{ (m/s)}$$

d=轴径 Shaft (mm)
C=摇摆频率 (次数/分) frequency
θ=摇摆角度 Oscillating angle

◇ 往复运动 Linear motion

$$V = \frac{2s \times c}{60} \text{ (m/s)}$$

s=行程长度 Stoke distance (m)
c=往复频率 (次数/分) frequency

CSB-EPB[®] Technical Information

CSB-EPB[®] 工程塑料轴承技术信息

轴承的速度 Bearing speed

CSB-EPB[®] 塑料轴承所允许的最大速度见图8。这些数值是在轴承载荷极小时取得的极限速度，实际运用中这些速度是很难达到的，因为轴承在工作中不可避免的要承受工作载荷，当轴承载荷加大时所允许的运行速度就会减小。由于轴承的速度与轴承的运行温度成反比关系，所以轴承不同的运行方式所允许的最大速度也不同。

图表8: CSB-EPB[®] 塑料轴承最大运行速度
Graph 8: Max. operation speed

材料 Material	旋转 Rotation	摆动 Oscillating	直线 Linear
EPB	1.0	0.7	3.0
EPBH	0.8	0.6	2.5
EPB1	1.0	0.7	3.0
EPB2	1.0	0.7	3.0
EPB2D	1.2	0.8	3.0
EPB3	1.0	0.7	4.0
EPB3G	0.8	0.6	3.5
EPB3M	0.8	0.6	2.5
EPB4	1.0	0.7	3.0
EPB5	1.5	1.1	5.0
EPB5A	0.6	0.4	1.0
EPB5Z	1.5	1.1	5.0
EPB6	1.0	0.7	3.0
EPB6A	0.6	0.4	1.0
EPB7	1.0	0.7	4.0
EPB8	1.2	0.8	4.0
EPB9	0.8	0.6	3.0
EPB10	1.5	1.1	5.0
EPB11	0.5	0.4	1.0
EPB12	1.0	0.7	5.0
EPB13	1.5	1.1	8.0
EPB15	1.0	0.7	4.0
EPB16	1.0	0.7	3.0
EPB18	1.0	0.7	3.0
EPB19	1.2	0.8	4.0
EPB20	0.5	0.4	2.0
EPB21	1.5	1.1	5.0
EPB22	1.0	0.7	4.0
EPB23	1.0	0.8	2.5
EPB24	1.0	0.7	1.0
EPB25	1.3	1.0	4.0
EPB26	0.9	0.6	2.0

The maximum operating speed: Rotation, Oscillating, Linear indicates the maximum allowable speed (Graph 8).

The value in the datasheet is calculated under the condition of a very low load. So the actual allowable speed will be limited against different load and other conditions. The higher the load, the lower the speed will be. The speed and the temperature is in a inverse proportion relation, the maximum speed allowable will be different depending on different operation method of the bearings.

图表9: CSB-EPB[®] 塑料轴承最高运行温度
Graph 9: Max. operation temperature

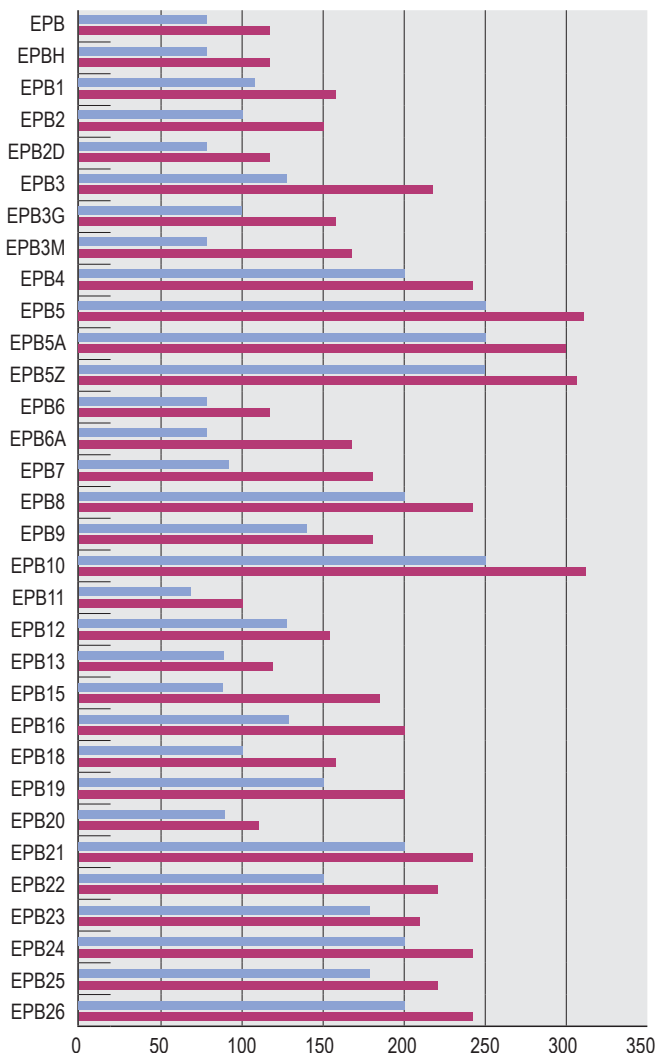

轴承的温度 Bearing temperature

CSB-EPB[®] 塑料轴承都限定了最低和最高使用温度。最低使用温度是指轴承材料会变脆的临界温度 (图表10)，最高使用温度是指轴承耐磨性能不会改变的临界温度，短期运

行最高温度是指轴承材料会变软的临界温度(图表9)。如轴承经常在高温和低温下交替使用，轴承有可能发生脱落现象，所以此时必须借助于辅助装置确保轴承正常运行。

There is a limited temperature range that CSB-EPB® plastic bearings could be used. The lowest temperature is the one the material will become brittle under that value (Graph 10) and the highest temperature is the one the bearing material wear resistance feature will start to

change (Graph 9). If the bearings are used under the conditions of alternatively changing high and low temperature, the bearing feature will be considerably affected and thus shorten the bearing service life.

图表10: CSB-EPB® 塑料轴承最低运行温度 Graph 10: Min. operation temperatures

材料 Materials	最低温度 Min. Temperature	材料 Materials	最低温度 Min. Temperature	材料 Materials	最低温度 Min. Temperature
EPB	-40	EPB5Z	-100	EPB16	-40
EPBH	-40	EPB6	-40	EPB18	-40
EPB1	-40	EPB6A	-40	EPB19	-40
EPB2	-40	EPB7	-40	EPB20	-50
EPB2D	-40	EPB8	-40	EPB21	-40
EPB3	-40	EPB9	-40	EPB22	-40
EPB3G	-40	EPB10	-100	EPB23	-100
EPB3M	-40	EPB11	-100	EPB24	-40
EPB4	-40	EPB12	-40	EPB25	-100
EPB5	-100	EPB13	-50	EPB26	-40
EPB5A	-100	EPB15	-40		

图表11: CSB-EPB® 塑料轴承提供定位机构的起始温度表 Graph11: Temperature at which additional securing of the bearing is required

材料 Materials	起始温度 Min. Temperature	材料 Materials	起始温度 Min. Temperature	材料 Materials	起始温度 Min. Temperature
EPB	50	EPB5Z	145	EPB16	90
EPBH	50	EPB6	50	EPB18	90
EPB1	60	EPB6A	50	EPB19	65
EPB2	55	EPB7	60	EPB20	80
EPB2D	50	EPB8	100	EPB21	80
EPB3	100	EPB9	105	EPB22	100
EPB3G	90	EPB10	145	EPB23	140
EPB3M	60	EPB11	50	EPB24	110
EPB4	120	EPB12	50	EPB25	140
EPB5	135	EPB13	60	EPB26	100
EPB5A	130	EPB15	65		

轴承PV值 PV value

PV值是指轴承在一定的载荷和线速度条件下的乘积值，轴承的PV值是评价滑动轴承综合性能的一个重要指标。实际PV值与轴承的使用寿命成反比关系（图表12），因此建议设计时尽可能使用比较低的PV值，以确保轴承会有更长的使用寿命。

PV is the product of the specific bearing load P and the sliding speed V. It is a very important design data for the bearing application. The PV value is inverse proportional to the bearing service life (Graph 12). So it is recommended to consider a lower design PV value during the bearing selection.

图表12: 轴承PV Graph 12: PV Value

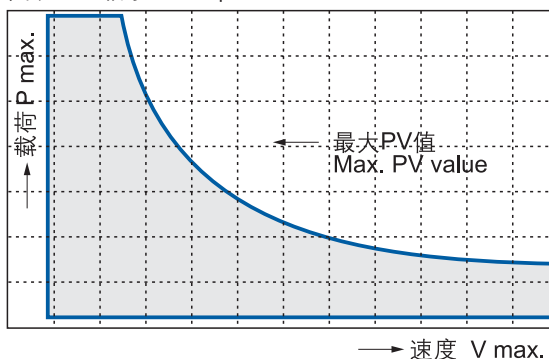

CSB-EPB[®] Technical Information

CSB-EPB[®] 工程塑料轴承技术信息

轴承PV值 PV value

$$PV_{Perm.} = \left(\frac{K1 \times \pi \times \lambda k \times \Delta T}{\mu \times s} + \frac{K2 \times \pi \times \lambda s \times \Delta T}{\mu \times b1 \times 2} \right) \times Y_1 \times Y_2 \times 10^{-3}$$

这里 There:

- K1, K2 = 散热系数
constant for heat dissipation
(K1=0.5, K2=0.042)
- s = 轴承的壁厚 (单位: 毫米)
bearing wall thickness [mm]
- b1 = 轴承的长度 (单位: 毫米)
bearing length [mm]
- μ = 摩擦系数
coefficient of friction
- λs = 轴的热传导性
thermal conductivity of the shaft
- λk = 轴承的热传导性
thermal conductivity of the bearing
- ΔT = $(T_a - T_u)$
 $(T_a - T_u)$
- T_u = 环境温度
ambient temperature [°C]
- T_a = 最高运行温度
max. application temperature [°C]
- Y_1 = 间歇操作的校正因子
Intermittent operation correction factor
- Y_2 = 润滑操作校正因子
Lubricating operation correction factor

图表13: PV值在间断运行下的修正系数 y_1
Graph 13: Correction factor of PV value by Intermittent Operation

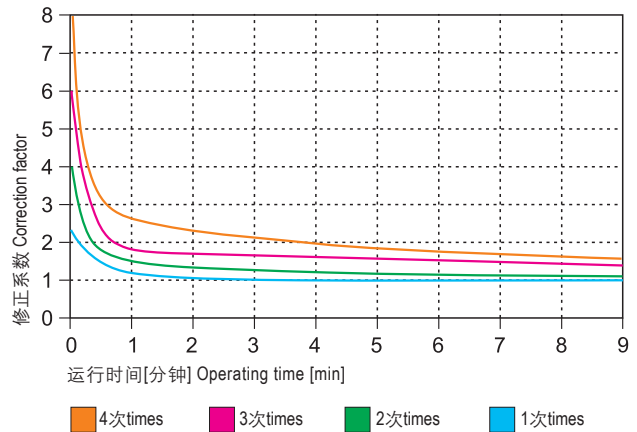

图表14: PV值在不同润滑方式时的修正系数 y_2
Graph 14: Correction factor of PV value by means of lubrication

润滑 Lubrication	修正系数 Correction factor
干运行 Dry	1
脂润滑 Grease	2
水润滑 Water	3
油润滑 Oil	4

图表15: 轴或基座材料的导热性
Graph 15: Heat conductivity values of shaft or housing materials

材料 Material	导热性 Thermal conductivity [W/m x k]
碳钢 Carbon steels	46
硬化钢 Hardened steel	46
硬铬轴 Hard chrome shaft	46
不锈钢 Stainless steel	16
铝合金 Hardened aluminum	204
塑料 Plastic	0.24

间断运行修正系数 y_1 Correction factor y_1 for intermittent operation

在很多场合轴承运行并不是连续工作，由于轴承短期工作（运行时间10分钟以内）而永远达不到最高允许温度，那么轴承允许的PV值就会增加，因为在停止运行时间内轴承因摩擦产生的摩擦热得到了充分的散发。图表13说明了轴承停止时间与运行时间不同比例下的轴承PV值修正系数 y_1 。

Commonly the bearings are not continuously running during most of the applications. The short time operation period (less than 10 minutes) does not allow the bearing reach the highest limited operation temperature so that the limited PV value will increase because during the stop period, the heat generated by the friction will be reduced. Graph 13 shows the intermittent operation correction factor y_1 for different stop and operate period.

润滑运行修正系数 y_2 Correction factor y_2 for lubricating operation

虽然CSB-EPB®塑料轴承是专为干摩擦应用所设计，但是其对通用油脂等大部分润滑介质均具有良好的兼容性；在轴承启动阶段加入润滑介质可以提高轴承的启动性能，从而缩短轴承的磨合期。而且轴承在有润滑介质存在时其承载能力会大幅度提高，因为有外界润滑干预的情况下轴承摩擦生热值大幅度降低，轴承温度降低后承载能力也就随之提高。图表14说明在各种润滑介质下PV值修正系数 y_2 。

Although CSB-EPB® plastic bearings are normally designed for the dry operation, it has good the general lubricant such as oil or grease. The initial oil or grease lubricating will improve the starting performance of the bearings and therefore achieves a shorter run-in time. At the same time, the using of lubricants considerably improves the loading capability of the bearings because the lubricants will reduce the temperature increasing during the operation so that the loading capability of the bearings is improved. Graph 14 shows the PV correction factor y_2 for different lubricants are used.

轴承的磨损 Bearing wear

由于轴承的耐磨性能受到很多因素的影响，所以很难准确描述轴承的磨损或寿命。通过无数次的试验表明影响轴承耐磨性或寿命的因素有：载荷、速度、运动方式、轴材料与粗糙度、环境温度与灰尘、外界润滑介质类别等等。

轴承的耐磨性一般随着载荷、速度、温度的增加而逐渐降低，当有外界润滑介质存在时轴承的耐磨性会成倍提高。CSB推荐使用轴的粗糙度为Ra0.2 ~ Ra0.8，轴过于粗糙或太光滑都会导致磨损加剧，轴过于粗糙就像刮刀一样刮伤轴承的摩擦面，轴太光滑会在摩擦面与轴承表面发生胶合导致磨损增大。

对于轴的材料CSB-EPB塑料轴承没有特别限定，但由于各种轴材料对轴承的磨损影响程度不同，故CSB推荐使用较为通用的表面镀硬铬轴材料，对轴的硬度同样没有限定，但CSB推荐使用HRC35以上的轴材料，以避免轴承起始工作阶段轴的磨损。

As the bearings wear resistance affected by many factors, it is difficult to accurately describe bearing wear and life span. Through numerous experiments we can conclude that the main factors affect the anti-wear property are the load, moving method, speed, roughness of mating surfaces, ambient temperature and dust and type of the outside lubricating medium, etc.

When the load, speed and temperature increase, the wear resistance of bearings gradually reduced; when there is outside lubrication medium, the wear resistance could be doubled; CSB recommend the roughness of axis to be Ra0.2 ~ Ra0.8. If the shaft is too rough or too smooth, it might increase the wear. Although there is no special restriction on the using of shaft material for the CSB-EPB plastic bearings, CSB recommend the use of hard chrome plated shaft material. The recommended shaft hardness is over HRC35 in order to avoid the initial wear off on the shaft.

轴承抗UV性能 Bearing UV- resistance performance

滑动轴承用于户外设备时就会经常暴露在各种恶劣的环境中。抗UV性能是各种轴承材料抵抗UV射线破坏能力的一个重要指标。CSB-EPB®塑料轴承抗UV性能对照表见图表16。

Bearings used for outdoor equipments are constantly exposed to different critical environment. Anti-UV property is one of the most important indexes of a variety of bearing materials to resist UV-ray damage.

CSB-EPB® plastic bearings UV-resistance reference (Graph 16).

CSB-EPB[®] Technical Information

CSB-EPB[®] 工程塑料轴承技术信息

轴承化学抗性 Chemical resistibility

CSB-EPB[®] 塑料轴承常常被用于有化学介质接触的场所，此时轴承的抗化学腐蚀性能就显得尤为重要。由于化学介质可能会导致轴承材料在结构成份上发生变化，这种变化主要取决于化学介质的种类、温度、暴露时间以及轴承的载荷与运动方式，有时化学介质充当了有效的润滑剂从而会延长轴承的使用寿命。在所有的塑料轴承产品中，EPB5、EPB5A和EPB10的化学抗性最突出，几乎能抵抗所有化学介质。详见图表16。

CSB-EPB[®] plastic bearings are usually used under the conditions where chemical media exist. Therefore the chemical resistance feature is very important for such a critical application. The existing chemical media may cause deep changes to the performance of the bearing material depending on the different conditions such as the chemical kinds, temperature, and the contacting period to the bearing materials as well as the load and operation speed. Sometimes chemical medium act as an effective lubricant and thus will extend the service life of bearings. Plastic bearings in all products, CSB-EPB5, EPB5A and EPB10 of the most striking Features of chemical-resistant, resistant to virtually all chemical media (Graph 16).

图表 16: CSB-EPB[®] 塑料轴承抗UV性能和化学抗性 Graph 16: CSB-EPB[®] Plastic bearings UV- resistance and Chemical resistance

型号 Type	油、油脂 Oil&Grease	弱酸 Diluted Acid	强酸 Strong Acid	弱碱 Diluted Alkal	强碱 Strong Alkali	抗UV性能 UV Resistibility	抗辐射 Radiation resistance
EPB	●	●	●	●	●	●●●●●	3 × 10 ² Gy
EPBH	●	●	●	●	●	●●●●●	3 × 10 ² Gy
EPB1	●	●	●	●	●	●●●●●	5 × 10 ² Gy
EPB2	●	●	●	●	●	●●●●●	5 × 10 ² Gy
EPB2D	●	●	●	●	●	●●●	3 × 10 ² Gy
EPB3	●	●	●	●	●	●●●●●	3 × 10 ² Gy
EPB3G	●	●	●	●	●	●●●●●	3 × 10 ² Gy
EPB3M	●	●	●	●	●	●●●●	1 × 10 ⁴ Gy
EPB4	●	●	●	●	●	●●	2 × 10 ² Gy
EPB5	●	●	●	●	●	●●●●●	1 × 10 ⁶ Gy
EPB5A	●	●	●	●	●	●●●●●	1 × 10 ⁶ Gy
EPB5Z	●	●	●	●	●	●●●	1 × 10 ⁶ Gy
EPB6	●	●	●	●	●	●●●●●	3 × 10 ² Gy
EPB6A	●	●	●	●	●	●●●	1 × 10 ⁴ Gy
EPB7	●	●	●	●	●	●●●	3 × 10 ² Gy
EPB8	●	●	●	●	●	●●●●●	2 × 10 ² Gy
EPB9	●	●	●	●	●	●●●●●	3 × 10 ² Gy
EPB10	●	●	●	●	●	●●●●●	1 × 10 ⁶ Gy
EPB11	●	●	●	●	●	●●	2 × 10 ⁴ Gy
EPB12	●	●	●	●	●	●●	3 × 10 ² Gy
EPB13	●	●	●	●	●	●●●	3 × 10 ² Gy
EPB15	●	●	●	●	●	●●●	3 × 10 ² Gy
EPB16	●	●	●	●	●	●●●●●	5 × 10 ² Gy
EPB18	●	●	●	●	●	●●●●●	3 × 10 ² Gy
EPB19	●	●	●	●	●	●●●●	3 × 10 ² Gy
EPB20	●	●	●	●	●	●●●	3 × 10 ² Gy
EPB21	●	●	●	●	●	●●	2 × 10 ² Gy
EPB22	●	●	●	●	●	●●●●●	3 × 10 ² Gy
EPB23	●	●	●	●	●	●●●●	2 × 10 ² Gy
EPB24	●	●	●	●	●	●	2 × 10 ² Gy
EPB25	●	●	●	●	●	●●	2 × 10 ² Gy
EPB26	●	●	●	●	●	●●●	2 × 10 ⁴ Gy

● 完全抵抗 Resistant ● 部分抵抗 Conditionally Resistant ● 无抵抗 Not Resistant
 ●●●●● 非常好 Very Good ● 一般 Generality

EPB

CSB-EPB[®]

www.csb-ep.com
sales@csb-ep.com

Tel: 0086 573 84186133/84185527
Fax: 0086 573 84185517

轴承安装 Bearing installation

■ 座孔: CSB-EPB® 塑料轴承配合座孔的材料无特别限定, 但座孔一端必须倒角25° 以避免轴承压入时刮伤外径, 压装时应该采用阶梯芯轴缓慢压入, 禁止直接击打端面, 以免变形影响轴承尺寸, CSB-EPB® 塑料轴承产品内径公差均是压入H7标准孔后所得。

■ 轴: CSB-EPB® 塑料轴承配合轴的材料无特别限定, 但CSB推荐使用镀铬硬轴。为了使轴在装配过程中更简单且不损伤轴承内摩擦面, 轴的端面必须有倒角圆滑过渡。另外轴表面粗糙度对轴承的摩擦系数有较大影响, 轴太光滑摩擦面会产生爬行现象或产生尖叫声, 轴表面太粗糙会加快轴承磨损。CSB推荐使用轴表面粗糙度为Ra0.2~Ra0.8, 轴承摩擦系数与表面粗糙度关系见图表19。

CSB-EPB® 塑料轴承配合公差按照ISO 3547-1标准设计制造见图表18。虽然CSB-EPB® 塑料轴承产品设计为自润滑产品, 但在装配时在摩擦面上涂上适量的外部润滑剂(比如油脂)会缩短轴承的磨合期从而延长轴承的使用寿命。

■ 粘接剂: CSB-EPB® 塑料轴承装配时一般不需要使用粘接剂, 但是如果需要使用粘接剂轴承在高温下工作, 要选用同等耐高温的胶粘剂, CSB建议对这种情况进行必要的测试。

■ Housing: The bearing housing and the fitting tools must be kept clean during the assembling. A chamfer of 25° on the housing should be ensured for an easy assembling. A stepped press pin is recommended to be used for the assembling. The inner diameter of the CSB-EPB® plastic bearings is measured after the bushing is fitted into the H7 housing.

■ Shaft: There is no critical requirement for the shaft material but chrome plated shaft is recommended for better operation. Rounded chamfer is required on the shaft for easy assembling. CSB recommend the shaft roughness to be in the range of Ra0.2~Ra0.8. Please refer to Graph 15 for the relation between the surface roughness and bearing friction coefficient (Graph:19).

CSB-EPB® plastic bearings are designed according to ISO 3547 Standard (Graph 18). Although the CSB-EPB® plastic bearings are designed for self-lubricating purpose, but the initial lubricating helps the assembling and the future operation of the bearings.

■ Adhesive agent: CSB-EPB® plastic bearings assembly generally needn't use glue, in case the glue is necessary, please consider the used glue can also work properly at the required temperature. Relative testing is recommended in this case.

图表17: 压装图 Graph 17: Assembly example

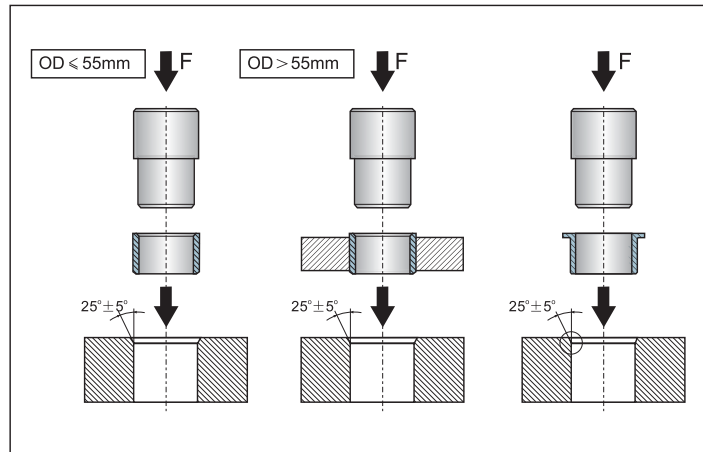

图表18: CSB-EPB® 塑料轴承配合公差[mm]
Graph 18: Plastic plain bearings tolerance

直径 Diameter d	压装后公差 Tolerance after being assembled			孔径 Housing H7	轴径 Shaft h9
	E10	F10	D11		
>0 ~ 3	+0.014 +0.054	+0.006 +0.046	+0.020 +0.080	0 +0.010	0 -0.025
>3 ~ 6	+0.020 +0.068	+0.010 +0.058	+0.030 +0.105	0 +0.012	0 -0.030
>6 ~ 10	+0.025 +0.083	+0.013 +0.071	+0.040 +0.130	0 +0.015	0 -0.036
>10 ~ 18	+0.032 +0.102	+0.016 +0.086	+0.050 +0.160	0 +0.018	0 -0.043
>18 ~ 30	+0.040 +0.124	+0.020 +0.104	+0.065 +0.195	0 +0.021	0 -0.052
>30 ~ 50	+0.050 +0.150	+0.025 +0.125	+0.080 +0.240	0 +0.025	0 -0.062
>50 ~ 80	+0.060 +0.180	+0.030 +0.150	+0.100 +0.290	0 +0.030	0 -0.074
>80 ~ 120	+0.072 +0.212	+0.036 +0.176	+0.120 +0.340	0 +0.035	0 -0.087
>120 ~ 180	+0.085 +0.245	+0.043 +0.203	+0.145 +0.395	0 +0.040	0 -0.100



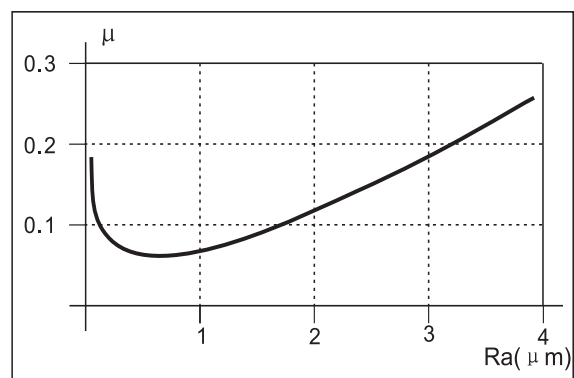





















图表19: 摩擦系数 μ 与轴表面粗糙度Ra的关系
Graph 19: Friction coefficient μ & surface roughness Ra



CSB-EPB[®] Plastic Plain Bearings

CSB-EPB[®] 工程塑料轴承

基本功能 Basic function

通用型 General	 CSB-EPB 通用性更强 The most common material P 28-30	 CSB-EPB1 特别适合用于卡车尾箱铰链 Especially suitable for truck hinges P 34-36	 CSB-EPB3 增强型 高承载 Enhanced type P 43-45
高载型 High load	 CSB-EPB12 特别适合高载下摇摆运动 Especially suitable for oscillation P 85-87	 CSB-EPB22 极高载耐磨材料 Good wear resistance under extremely high load P 109-111	 CSB-EPB5 耐高温 抗化学性极佳 High temperature Excellent chemical resistance P 55-57
耐高温 High temperature	 CSB-EPB4 耐温200℃ Work consecutively at 200℃ P 52-54	 CSB-EPB24 耐温200℃ 适用于燃油系统 Temperature up to 200℃ For use in fuel oil P 115-117	 CSB-EPB5 耐温250℃ 高化学抗性 Work consecutively at 250℃, Good chemical resistance P 55-57
低摩擦系数 Low friction coefficient	 CSB-EPB13 快慢速下保持较低的摩擦系数 Maintain low friction coefficient either at high or low speed P 88-90	 CSB-EPB7 适合高速运动 高耐磨性 Suitable for high speed High wear resistance P 70-72	 CSB-EPB11 不含PTFE和硅, 轻载 耐磨性极好, 高冲击力性, 适合软轴 Not PTFE and Silicon. Good wear resistance for low load. Suitable for soft shaft P 82-84
耐腐蚀 Anti-corrosion	 CSB-EPB4 耐温200℃ Work consecutively at 200℃ P 52-54	 CSB-EPB5 耐温250℃ 耐腐蚀更强 Work consecutively at 250℃ Highest corrosion resistance P 55-57	 CSB-EPB8 耐温200℃ 水下运行专用 Work consecutively at 200℃, Specialized underwater operation P 73-75
潮湿环境 Humid environment	 CSB-EPB2 适合潮湿环境 Good for Humidity condition P 37-39	 CSB-EPB4 高强度, 耐化学腐蚀 High strength Good chemical resistance P 52-54	 CSB-EPB8 适合水下运行 Underwater operation P 73-75
食品安全等级FDA grade	 CSB-EPB5A 耐温250℃ FDA食品等级认可 High temperature 250℃ FDA grade P 58-60	 CSB-EPB6 适合软轴 允许接触食品 Soft shaft available Food-classic P 64-66	 CSB-EPB6A 用于食品或烟草行业, 适合低速运动 For the food and tobacco industry, Low speed P 67-69
经济型 Economic	 CSB-EPBH 经济通用 General Type P 31-33	 CSB-EPB2D 低摩擦系数, 最经济 Low Friction coefficient Low cost P 40-42	 CSB-EPB3G 高强度 High strength P 46-48

EPB

CSB-EPB[®]

www.csb-ep.com
sales@csb-ep.com

Tel: 0086 573 84186133/84185527
Fax: 0086 573 84185517

 <p>CSB-EPB7 高耐磨性, 电梯行业应用, 适合软轴 High wear resistance, Used in lift industry, Suitable for soft shaft P 70-72</p>	 <p>CSB-EPB13 适合快慢速、适合软轴 Suitable for high and low speed with soft shaft P 88-90</p>	 <p>CSB-EPB15 高耐磨 长寿命 High wear resistance Long service life P 91-93</p>	 <p>CSB-EPB18 低吸水率, 高耐磨 Low water absorption, Good wear resistance P 97-99</p>
 <p>CSB-EPB5Z 特别适合摇摆运动 Especially suitable for oscillation P 61-63</p>	 <p>CSB-EPB10 耐高温, 高强度 抗化学性极好 High temperature Excellent chemical resistance P 79-81</p>		
 <p>CSB-EPB10 耐温250℃, 高强度 Work consecutively at 250℃ High strength P 79-81</p>	 <p>CSB-EPB21 高温耐磨材料 Good wear resistance for high temperature P 106-108</p>	 <p>CSB-EPB26 适合高温和软轴应用 For soft shafts and high temperatures P 121-123</p>	 <p>CSB-EPB8 耐温200℃ 水下运行专用 Work consecutively at 200℃, Specialized underwater operation P 73-75</p>
 <p>CSB-EPB18 低吸水率, 高耐磨 Low water absorption, Good wear resistance P 97-99</p>	 <p>CSB-EPB15 高耐磨 长寿命 High wear resistance Long service life P 91-93</p>	 <p>CSB-EPB5Z 特别适合摇摆运动 Especially suitable for oscillation P 61-63</p>	 <p>CSB-EPB 通用性更强 The most common material P 28-30</p>
 <p>CSB-EPB10 耐温250℃ 高抗压强度 Work consecutively at 250℃, High compressive strength P 79-81</p>	 <p>CSB-EPB26 适合高温和软轴应用 For soft shafts and high temperatures P 121-123</p>	 <p>CSB-EPB5Z 特别适合摇摆运动 Especially suitable for oscillation P 61-63</p>	
 <p>CSB-EPB16 适合高载荷 Suitable for high load P 94-96</p>	 <p>CSB-EPB20 水下的自润滑材料 A self-lubricating material for applications in water P 103-105</p>	 <p>CSB-EPB21 高温耐磨材料 Good wear resistance for high temperature P 106-108</p>	 <p>CSB-EPB1 特别适用于用于卡车尾箱铰链 Especially suitable for truck hinges P 34-36</p>
 <p>CSB-EPB11 不含PTFE和硅, 轻载 耐磨性极好, 高冲击性, 适合软轴 Not PTFE and Silicon. Good wear resistance for low load. Suitable for soft shaft P 82-84</p>	 <p>CSB-EPB23 高温180℃食品行业应用 For use with temperatures up to 180℃ P 112-114</p>		
 <p>CSB-EPB3M 边缘载荷, 耐冲压, 适合低速运动 Marginal Load, Impact resistance, Low speed P 49-51</p>			

CSB-EPB[®] Material Properties Data Table

CSB-EPB[®] 材料数据表

材料性能 Material properties	测试标准 Standard	单位 Unit	EPB	EPB1	EPB2	EPB2D	EPB3	EPB3G
一般性能 General properties								
颜色 Color	-	-	深灰 Dark grey	棕色 Brown	橄榄绿 Olive	绿色 Green	深灰 Dark grey	黑色 Black
密度 Density	ISO1183	g/cm ³	1.46	1.53	1.39	1.40	1.46	1.37
最大吸湿率 Max. moisture absorption, 50%RH	ISO62	%	0.3	0.2	0.2	0.3	0.7	1.3
最大吸水率 Max. water absorption	ISO62	%	1.2	0.5	0.4	1.2	4.0	5.5
对钢动摩擦系数 Coefficient of sliding friction(steel)	ITS025	μ	0.05-0.15	0.08-0.20	0.07-0.20	0.05-0.25	0.08-0.18	0.05-0.15
极限PV值 Max. PV value	ITS026	N/mm ² × m/s	0.40	0.50	0.45	0.25	0.45	0.30
机械性能 Mechanical properties								
弯曲模量 Flexural modulus	ISO178	MPa	2300	2600	2400	2000	8500	7700
弯曲强度 Flexural strength	ISO178	MPa	60	65	60	65	210	190
最大静载荷 Max. static load	ITS027	MPa	35	55	50	30	80	75
最大动载荷 Max. dynamic load	ITS028	MPa	15	21	19	13	43	36
邵氏硬度 Shore hardness	ISO868	D	75	72	72	75	81	78
物理和热性能 Physical and thermal properties								
连续运行温度 Long-term application temperature	ITS029	℃	+80	+110	+100	+80	+130	+100
短时运行温度 Short-term application temperature	ITS029	℃	+120	+160	+150	+120	+220	+160
最低运行温度 Lowest application temperature	ITS029	℃	-40	-40	-40	-40	-40	-40
导热性 Thermal conductivity	ISO22007	W/m/K	0.20	0.26	0.25	0.25	0.24	0.24
线性热膨胀系数 Coefficient of thermal expansion	ISO11359	K ⁻¹ × 10 ⁻⁵	10	8	10	11	9	11
阻燃等级 Flammability	UL94	Class	HB	HB	HB	HB	HB	HB
导电性能 Electrical properties								
体电阻率 Volume resistance	IEC60093	Ω · cm	>10 ¹³	>10 ¹¹	>10 ¹²	>10 ¹³	>10 ¹³	>10 ¹²
面电阻率 Surface resistance	IEC60093	Ω	>10 ¹²	>10 ¹⁰	>10 ¹¹	>10 ¹²	>10 ¹¹	>10 ¹¹
页码 Page			P 28-30	P 34-36	P 37-39	P 40-42	P 43-45	P 46-48

*ITS: CSB内部测试标准 CSB company's internal test standards.

**除非特殊说明测试温度为23℃ Test temperatures are 23℃ unless otherwise stated.

EPB

CSB-EPB[®]

www.csb-ep.com
sales@csb-ep.com

Tel: 0086 573 84186133/84185527
Fax: 0086 573 84185517

EPB3M	EPB4	EPB5	EPB5A	EPB5Z	EPB6	EPB6A	EPB7	EPB8	EPB9	EPB10	EPB11
深灰 Dark grey	黑色 Black	黑色 Black	米色 Beige	棕色 Brown	白色 White	白色 White	米黄 Cream	深灰 Dark grey	黑色 Black	黑色 Black	白色 White
1.14	1.70	1.44	1.28	1.40	1.45	1.10	1.25	1.55	1.28	1.42	0.96
1.4	0.1	0.1	0.3	0.3	0.3	1.5	1.3	0.1	1.3	0.1	0.1
7.6	0.3	0.5	0.5	1.1	1.2	7.6	6.5	0.1	6.5	0.5	0.1
0.09-0.30	0.07-0.20	0.09-0.25	0.25-0.40	0.05-0.15	0.05-0.18	0.10-0.40	0.09-0.20	0.07-0.18	0.10-0.40	0.10-0.25	0.05-0.15
0.15	1.35	1.40	0.25	1.00	0.30	0.10	0.50	0.80	0.35	1.35	0.20
2700	12000	4800	3600	4200	2300	1300	3200	8000	10000	10000	1200
100	165	165	140	150	60	55	75	150	250	210	25
30	90	110	90	100	35	35	60	85	105	125	25
15	50	61	46	51	14	12	25	47	58	80	6
79	82	82	80	80	74	70	75	82	82	86	62
+80	+200	+250	+250	+250	+80	+80	+90	+200	+140	+250	+70
+170	+240	+315	+300	+310	+120	+170	+180	+240	+180	+315	+100
-40	-40	-100	-100	-100	-40	-40	-40	-40	-40	-100	-100
0.24	0.60	0.55	0.24	0.55	0.20	0.23	0.24	0.50	0.60	0.60	0.20
10	4	6	9	5	10	11	9	5	11	5	19
HB	V0	V0	V0	V0	HB	HB	HB	V0	HB	V0	HB
$>10^{12}$	$>10^5$	$>10^8$	$>10^{14}$	$>10^{11}$	$>10^{13}$	$>10^{13}$	$>10^{13}$	$>10^5$	$<10^3$	$>10^5$	$>10^{13}$
$>10^{11}$	$>10^5$	$>10^7$	$>10^{13}$	$>10^{11}$	$>10^{12}$	$>10^{12}$	$>10^{12}$	$>10^5$	$<10^3$	$>10^5$	$>10^{12}$
P 49-51	P 52-54	P 55-57	P 58-60	P 61-63	P 64-66	P 67-69	P 70-72	P 73-75	P 76-78	P 79-81	P 82-84

CSB-EPB[®] Material Properties Data Table

CSB-EPB[®] 材料数据表

材料性能 Material properties	测试标准 Standard	单位 Unit	EPB12	EPB13	EPB15	EPB16	EPB18	EPB19
一般性能 General properties								
颜色 Color	-	-	黑色 Black	黄色 Yellow	黄色 Yellow	黑色 Black	黄色 Yellow	深灰 Dark grey
密度 Density	ISO1183	g/cm ³	1.32	1.48	1.30	1.60	1.40	1.27
最大吸湿率 Max. moisture absorption, 50%RH	ISO62	%	0.9	0.3	1.3	0.2	0.3	1.3
最大吸水率 Max. water absorption	ISO62	%	4.9	1.3	6.5	0.4	0.5	4.5
对钢动摩擦系数 Coefficient of sliding friction(steel)	ITS025	μ	0.05-0.20	0.05-0.15	0.05-0.15	0.06-0.20	0.05-0.18	0.05-0.20
极限PV值 Max. PV value	ITS026	N/mm ² × m/s	0.55	0.40	0.90	0.40	0.40	0.60
机械性能 Mechanical properties								
弯曲模量 Flexural modulus	ISO178	MPa	2200	2600	4000	4900	2700	2800
弯曲强度 Flexural strength	ISO178	MPa	100	60	130	140	65	80
最大静载荷 Max. static load	ITS027	MPa	75	35	70	75	50	60
最大动载荷 Max. dynamic load	ITS028	MPa	43	14	35	38	21	22
邵氏硬度 Shore hardness	ISO868	D	83	74	79	80	75	72
物理和热性能 Physical and thermal properties								
连续运行温度 Long-term application temperature	ITS029	℃	+135	+90	+90	+130	+100	+150
短时运行温度 Short-term application temperature	ITS029	℃	+155	+120	+180	+200	+160	+200
最低运行温度 Lowest application temperature	ITS029	℃	-40	-50	-40	-40	-40	-40
导热性 Thermal conductivity	ISO22007	W/m/K	0.24	0.25	0.24	0.25	0.25	0.25
线性热膨胀系数 Coefficient of thermal expansion	ISO11359	K ⁻¹ × 10 ⁻⁵	5	10	8	4	8	10
阻燃等级 Flammability	UL94	Class	HB	HB	HB	HB	HB	HB
导电性能 Electrical properties								
体电阻率 Volume resistivity	IEC60093	Ω · cm	>10 ¹¹	>10 ¹³	>10 ¹³	>10 ¹³	>10 ¹²	>10 ¹³
面电阻率 Surface resistivity	IEC60093	Ω	>10 ¹¹	>10 ¹²	>10 ¹²	>10 ¹²	>10 ¹¹	>10 ¹¹
页码 Page			P 85-87	P 88-90	P 91-93	P 94-96	P 97-99	P 100-102

*ITS: CSB内部测试标准 CSB company's internal test standards.

**除非特殊说明测试温度为23℃ Test temperatures are 23℃ unless otherwise stated.

EPB

CSB-EPB[®]

www.csb-ep.com
sales@csb-ep.com

Tel: 0086 573 84186133/84185527
Fax: 0086 573 84185517

	EPB20	EPB21	EPB22	EPB23	EPB24	EPB25	EPB26	EPBH	MN2	MN3	MN9	MR4
	黑色 Black	米色 Beige	浅棕色 Light brown	蓝色 Blue	棕色 Brown	黄色 Yellow	米色 Beige	黑色 Black	深灰 Dark grey	浅黄色 Light yellow	黑色 Black	灰色 Grey
	1.53	1.53	1.49	1.42	1.72	1.44	1.51	1.43	1.65	1.42	1.45	1.48
	0.2	0.1	1.1	0.6	0.1	0.3	0.1	0.3	0.2	0.3	0.2	0.3
	0.8	0.3	4.6	1.9	0.2	1.6	0.2	1.2	0.7	1.3	0.4	1.3
	0.15-0.35	0.05-0.20	0.15-0.35	0.10-0.20	0.08-0.25	0.08-0.20	0.15-0.20	0.05-0.20	0.10-0.18	0.05-0.20	0.15-0.25	0.05-0.20
	0.15	0.80	0.70	0.40	0.60	0.45	0.50	0.30	0.30	0.50	0.40	0.30
	7200	2800	9000	2000	10000	4500	4500	2000	2400	2700	2000	2350
	120	55	240	110	210	100	95	60	53	70	70	60
	70	80	95	60	110	60	55	30	30	45	65	35
	35	37	49	26	58	30	22	12	12	24	29	19
	79	77	80	76	81	79	74	74	73	73	76	74
	+90	+200	+150	+180	+200	+180	+200	+80	+90	+90	+120	+90
	+110	+240	+220	+210	+240	+220	+240	+120	+120	+120	+165	+120
	-50	-40	-40	-100	-40	-100	-40	-40	-50	-50	-40	-50
	0.60	0.24	0.24	0.24	0.24	0.24	0.24	0.20	0.24	0.25	0.60	0.25
	6	6	8	8	5	7	3	10	8	13	5	10
	HB	V0	HB	V0	V0	V0	V0	HB	HB	HB	HB	HB
	<10 ⁵	>10 ¹²	>10 ¹³	>10 ¹¹	>10 ¹³	>10 ¹³	>10 ¹²	>10 ¹³	>10 ⁹	>10 ¹²	<10 ⁹	>10 ¹³
	<10 ⁵	>10 ¹¹	>10 ¹¹	>10 ¹¹	>10 ¹²	>10 ¹⁰	>10 ¹²	>10 ¹²	>10 ⁹	>10 ¹²	<10 ⁹	>10 ¹²
	P 103-105	P 106-108	P 109-111	P 112-114	P 115-117	P 118-120	P 121-123	P 31-33	n.d	n.d	n.d	n.d



● 标准产品规格表 Standard specifications: P124

产品特性 Product features

- 通用性更强的CSB塑料轴承。可满足工作温度80度以下的大部分应用场合，出色的耐磨性能和合理的价格往往是设计工程师的优选材料。
- 连续使用温度：-40℃/+80℃
- 通用性强适合多数中低载荷场合
- 适合干运行、免维护
- 不同轴材料磨损很小
- 较低的摩擦系数
- The most common CSB plastic bearing material. It is suitable for the applications with working temperature not higher than 80 °C. It is the preferable material with good wear resistance and economic efficient for a new designation
- Continuous working temperature: -40 °C/+80 °C
- Very common; suitable for most of average and low load
- Maintenance-free dry operation
- Light wear against different shaft materials
- Low friction

材料数据表 Material properties data table

材料性能 Material properties	测试标准 Standard	单位 Unit	CSB-EPB
颜色 Color	-	-	深灰 Dark grey
密度 Density	ISO1183	g/cm ³	1.46
最大吸湿率 Max. moisture absorption, 50%RH	ISO62	%	0.3
最大吸水率 Max. water absorption	ISO62	%	1.2
对钢动摩擦系数 Coefficient of sliding friction(steel)	ITS025	μ	0.05-0.15
极限PV值 Max. PV value	ITS026	N/mm ² × m/s	0.40
弯曲模量 Flexural modulus	ISO178	MPa	2300
弯曲强度 Flexural strength	ISO178	MPa	60
最大静载荷 Max. static load	ITS027	MPa	35
最大动载荷 Max. dynamic load	ITS028	MPa	15
邵氏硬度 Shore hardness	ISO868	D	75
连续运行温度 Long-term application temperature	ITS029	°C	+80
短时运行温度 Short-term application temperature	ITS029	°C	+120
最低运行温度 Lowest application temperature	ITS029	°C	-40
导热性 Thermal conductivity	ISO22007	W/m/K	0.20
线性热膨胀系数 Coefficient of thermal expansion	ISO11359	K ⁻¹ × 10 ⁻⁵	10
阻燃等级 Flammability	UL94	Class	HB
体电阻率 Volume resistance	IEC60093	Ω · cm	>10 ¹³
面电阻率 Surface resistance	IEC60093	Ω	>10 ¹²

*ITS: CSB内部测试标准 CSB company's internal test standards.

**除非特殊说明测试温度为23℃ Test temperatures are 23 °C unless otherwise stated.

轴承PV值 PV value

CSB-EPB塑料轴承最大运行PV值为0.4N/mm² × m/s; 由此决定轴承所承受的载荷与速度成反比，详细查阅图表EPB-1。

The max PV value of the CSB-EPB plastic bearings is 0.4N/mm² × m/s which determines the load capacity of bearing is inversely proportional to the speed. Please refer to the chart for more detailed information (Graph EPB-1).

■ PV图表 Permissible PV value for CSB-EPB

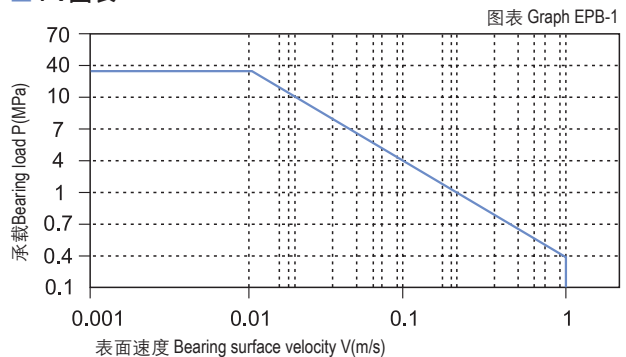

轴承的载荷、速度、温度 Load, speed and temperature

CSB-EPB塑料轴承可承受最大静载荷为35Mpa，在此载荷下轴承的最大压缩变形量参考图表EPB-2，轴承实际工作载荷略小于35Mpa，载荷还受到运行速度以及温度的影响，速度越快 (Vmax: 1.0m/s) 会导致摩擦温度上升，而温度上升 (Tmax: 80℃) 会导致轴承的承载能力逐渐减弱，载荷随轴承工作温度变化情况参考图表EPB-3。

CSB-EPB allows the Max static load of 35Mpa, The max compressive deformation rate under the max load is listed in Graph EPB-2, The actual load capacity of bearing is slightly less than 35Mpa, The bearing load is variable against the speed and temperature, Fast speed (Vmax: 1.0m/s) results into higher temperature (Tmax: 80℃) which decreases the load capacity of the bearing. Please refer to the Graph EPB-3 for such variation.

轴承的摩擦系数、磨损、轴材料 Friction factor, wear and shaft material

摩擦系数 Friction factor

CSB-EPB塑料轴承摩擦系数受运行速度以及轴承载荷变化影响相对较小 (见图表EPB-4与图表EPB-5)，这也是CSB-EPB作为塑料轴承通用型号选择的因素；此轴承可以保持一直比较低的摩擦系数从而确保了整个摩擦磨损性能的优越性。根据图表EPB-6显示CSB-EPB轴承的摩擦系数还会受到对磨轴表面粗糙度的影响而发生变化，我们推荐此轴承使用轴表面粗糙度值为Ra0.3 ~ 0.5um。

CSB-EPB friction factor is not sensitive to the operation speed and bearing loading (see Graph EPB-4 and Graph EPB-5). The above features are the most common considerations for the bearing material selection. The friction of CSB-EPB could be maintained at a relatively lower level so that the good wearing features are guaranteed. From the Graph EPB-6, we could see that the friction factor is variable against the changing of shaft roughness. The recommended shaft roughness is Ra0.3~0.5.

摩擦系数与轴表面粗糙度关系图表

Coefficient of friction & the surface roughness of shaft

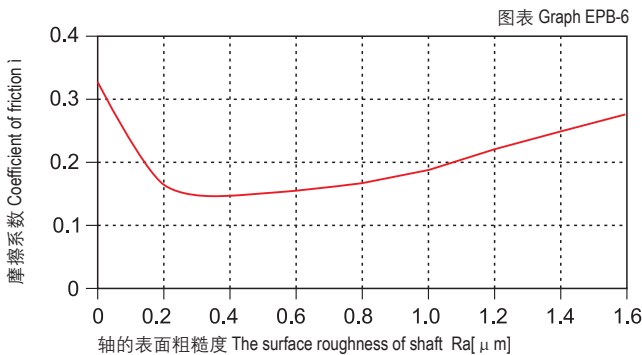

载荷-温度-变形量图表 Load-Temperature deformation

图表 Graph EPB-2

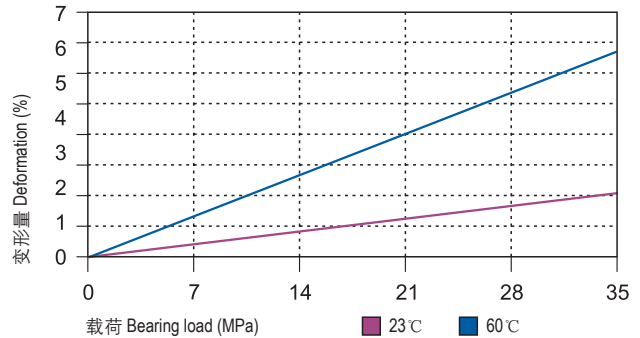

载荷-温度图表 Load-Temperature diagrams

图表 Graph EPB-3

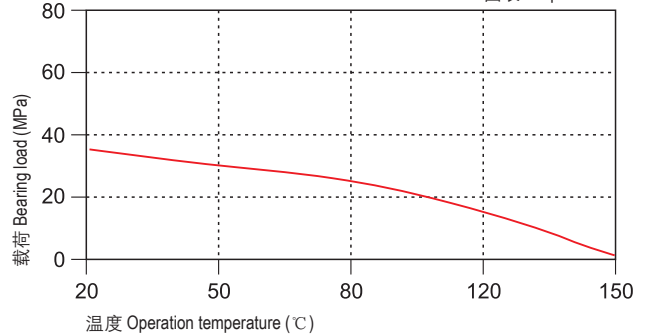

摩擦系数与速度变化关系图表 P=2MPa

Coefficient of friction & the speed of bearing, p = 2 MPa

图表 Graph EPB-4

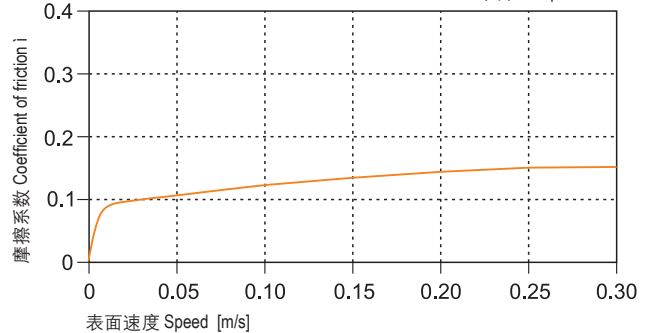

摩擦系数与载荷变化关系图表 v=0.2m/s

Coefficient of friction & the pressure of bearing, v = 0.2 m/s

图表 Graph EPB-5

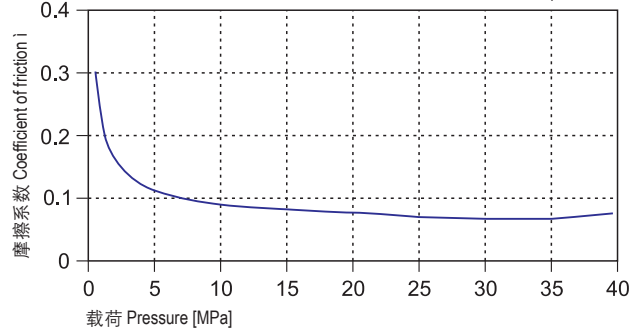

CSB-EPB	干运行 Dry	油脂 Grease	油 Oil	水 Water
摩擦系数 μ Friction coef.	0.05-0.15	0.09	0.04	0.04

磨损与轴材料 Wearing and shaft material

轴材料对轴承的磨损有很大影响，但CSB-EPB塑料轴承适合几乎所有的轴材料；通过图表EPB-7与图表EPB-8可以看出当使用硬铬钢轴或硬化钢轴以及硬化铝轴时CSB-EPB塑料轴承的磨损特性都非常出色。

The shaft material is an important media for the bearing wearing but CSB-EPB is suitable for almost all kinds of shaft materials. Graph EPB-7 and Graph EPB-8 show that the wearing feature of CSB-EPB is excellent when the shaft material are hardened chrome steel or hardened steel or hardened Aluminum.

化学抗性 Chemical resistance

CSB-EPB塑料轴承能抵抗弱碱、弱酸以及各类润滑油的腐蚀。CSB-EPB is good at chemical resistance against mild base, weak acidic medium and various kinds of lubricants.

吸水性 Water absorption

CSB-EPB塑料轴承在标准大气中的吸湿率为0.3%。浸泡在水中最高吸水率为1.2%。较低的吸水率只有在极端应用中才需要更改轴承设计。

The moisture absorption of CSB-EPB plastic bearings is 0.3% in standard atmosphere. The max. water absorption is 1.2% in water. These values are so low that design changes due to absorption are only necessary in extreme applications.

抗UV性能 UV resistance

CSB-EPB塑料轴承长久暴露在紫外线下颜色基本不会改变。材料的硬度，抗压强度和耐磨性都不会改变。

CSB-EPB can maintain its color unchanged when it is exposed into the UV ray. The hardness, Compressive strength and wear resistance of the material is also stable under such condition.

安装公差 Installation tolerances

CSB-EPB塑料轴承压装后公差 Tolerances after pressfit

直径 Di. [mm]	CSB-EPB E10 [mm]	座孔 Housing H7 [mm]	轴 Shaft h9 [mm]
>0 - 3	+0.014 ~ +0.054	0 ~ +0.010	0 ~ -0.025
>3 - 6	+0.020 ~ +0.068	0 ~ +0.012	0 ~ -0.030
>6 - 10	+0.025 ~ +0.083	0 ~ +0.015	0 ~ -0.036
>10 - 18	+0.032 ~ +0.102	0 ~ +0.018	0 ~ -0.043
>18 - 30	+0.040 ~ +0.124	0 ~ +0.021	0 ~ -0.052
>30 - 50	+0.050 ~ +0.150	0 ~ +0.025	0 ~ -0.062
>50 - 80	+0.060 ~ +0.180	0 ~ +0.030	0 ~ -0.074
>80 - 120	+0.072 ~ +0.212	0 ~ +0.035	0 ~ -0.087
>120 - 180	+0.085 ~ +0.245	0 ~ +0.040	0 ~ -0.100

在不同轴材料上旋转时的磨损量 $p=2\text{MPa}, v=0.2\text{m/s}$

Wear under rotating with different shaft materials, $p = 2 \text{ MPa}$, $v = 0.2 \text{ m/s}$

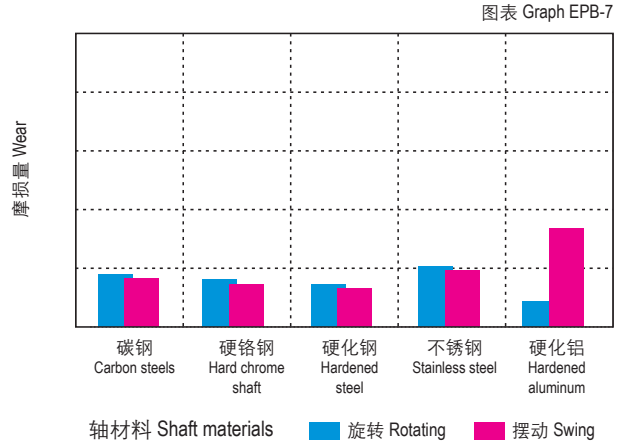

旋转磨损随轴材料与压力变化关系 $v=0.2\text{m/s}$

Wear & pressure under rotating with different shaft materials, $v = 0.2 \text{ m/s}$

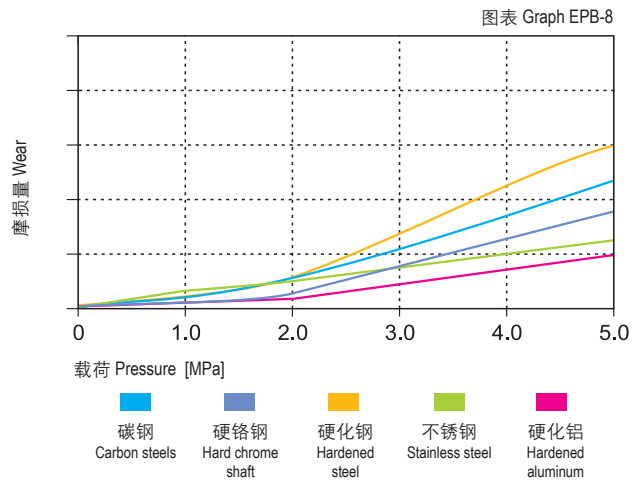

吸水性的影响 Effect of moisture absorption on EPB bearings

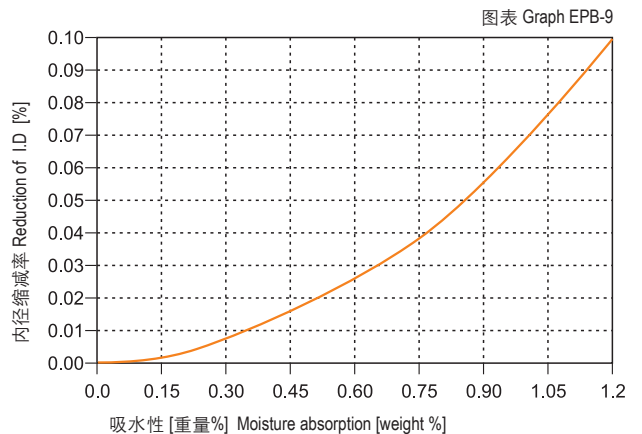



● 标准产品规格表 Standard specifications: P124

产品特性 Product features

- 作为兼顾耐磨性能和低廉的价格被开发的材料。适用于大批量低成本需求
- 连续使用温度: -40℃/+80℃
- 适合多数中低载荷场合
- 适合干运行、免维护
- 大批量、低成本要求
- This material is developed against the requirement of wear resistance and economic cost for cost effective and big quantity consuming applications
- Continuous working temperature: -40℃/+80℃
- Suitable for most of average and low load
- Maintenance-free dry operation
- Low cost for high quantities

材料数据表 Material properties data table

材料性能 Material properties	测试标准 Standard	单位 Unit	CSB-EPBH
颜色 Color	-	-	黑色 Black
密度 Density	ISO1183	g/cm ³	1.43
最大吸湿率 Max. moisture absorption, 50%RH	ISO62	%	0.3
最大吸水率 Max. water absorption	ISO62	%	1.2
对钢动摩擦系数 Coefficient of sliding friction(steel)	ITS025	μ	0.05-0.20
极限PV值 Max. PV value	ITS026	N/mm ² × m/s	0.30
弯曲模量 Flexural modulus	ISO178	MPa	2000
弯曲强度 Flexural strength	ISO178	MPa	60
最大静载荷 Max. static load	ITS027	MPa	30
最大动载荷 Max. dynamic load	ITS028	MPa	12
邵氏硬度 Shore hardness	ISO868	D	74
连续运行温度 Long-term application temperature	ITS029	℃	+80
短时运行温度 Short-term application temperature	ITS029	℃	+120
最低运行温度 Lowest application temperature	ITS029	℃	-40
导热性 Thermal conductivity	ISO22007	W/m/K	0.20
线性热膨胀系数 Coefficient of thermal expansion	ISO11359	K ⁻¹ × 10 ⁻⁵	10
阻燃等级 Flammability	UL94	Class	HB
体电阻率 Volume resistance	IEC60093	Ω · cm	>10 ¹³
面电阻率 Surface resistance	IEC60093	Ω	>10 ¹²

*ITS: CSB内部测试标准 CSB company's internal test standards.

**除非特殊说明测试温度为23℃ Test temperatures are 23℃ unless otherwise stated.

轴承PV值 PV value

CSB-EPBH塑料轴承最大运行PV值为0.3N/mm² × m/s; 由此决定轴承所承受的载荷与速度成反比, 详细查阅图表EPBH-1。

The max PV value of the CSB-EPBH plastic bearings is 0.3N/mm² × m/s which determines the load capacity of bearing is inversely proportional to the speed. Please refer to the chart for more detailed information (Graph EPBH-1).

■ PV图表 Permissible PV value for CSB-EPBH

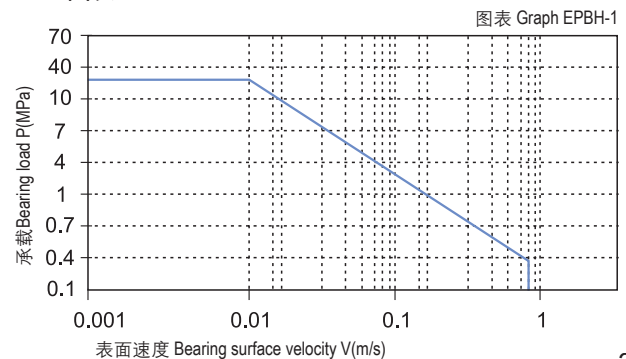

轴承的载荷、速度、温度 Load, speed and temperature

CSB-EPBH塑料轴承可承受最大静载荷为30Mpa, 在此载荷下轴承的最大压缩变形量参考图表EPBH-2, 轴承实际工作载荷略小于30Mpa, 载荷还受到运行速度以及温度的影响, 速度越快 (Vmax: 0.8m/s) 会导致摩擦温度上升, 而温度上升 (Tmax: 80℃) 会导致轴承的承载能力逐渐减弱, 载荷随轴承工作温度变化情况参考图表EPBH-3。

CSB-EPBH allows the Max static load of 30Mpa, The max compressive deformation rate under the max load is listed in Graph EPBH-2, The actual load capacity of bearing is slightly less than 30Mpa, The bearing load is variable against the speed and temperature, Fast speed (Vmax: 0.8m/s) results into higher temperature (Tmax: 80℃) which decreases the load capacity of the bearing. Please refer to the Graph EPBH-3 for such variation.

轴承的摩擦系数、磨损、轴材料 Friction factor, wear and shaft material

摩擦系数 Friction factor

CSB-EPBH塑料轴承摩擦系数受运行速度以及轴承载荷变化影响相对较小 (见图表EPBH-4与图表EPBH-5), 这也是CSB-EPBH作为塑料轴承通用型号选择的因素; 此轴承可以一直保持比较低的摩擦系数从而确保了整个摩擦磨损性能的优越性。根据图表EPBH-6显示CSB-EPBH塑料轴承的摩擦系数还会受到对磨轴表面粗糙度的影响而发生变化, 我们推荐此轴承使用轴表面粗糙度值为Ra0.3~0.5um。

CSB-EPBH friction factor is not sensitive to the operation speed and bearing loading (see Graph EPBH-4 and Graph EPBH-5). The above features are the most common considerations for the bearing material selection. The friction of CSB-EPBH could be maintained at a relatively lower level so that the good wearing features are guaranteed. From the Graph EPBH-6, we could see that the friction factor is variable against the changing of shaft roughness. The recommended shaft roughness is Ra0.3~0.5.

摩擦系数与轴表面粗糙度关系图表 Coefficient of friction & the surface roughness of shaft

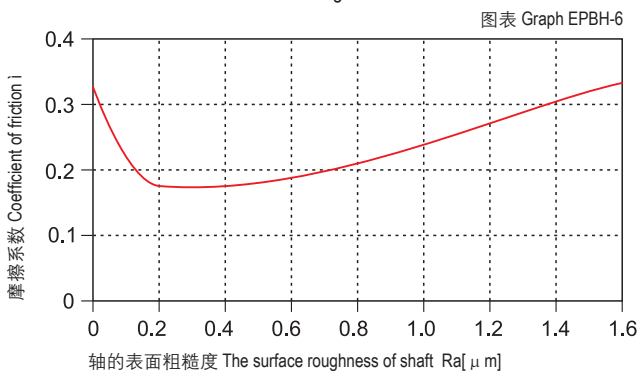

载荷-温度-变形量图表 Load-Temperature deformation

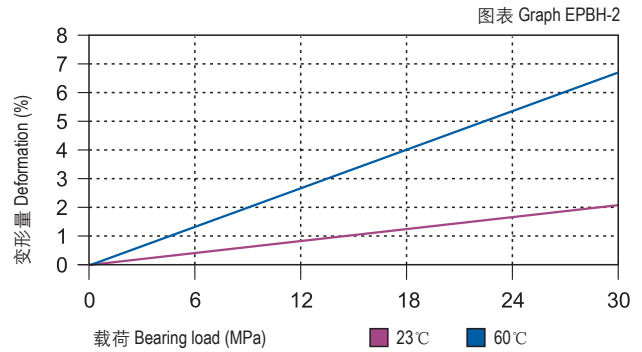

载荷-温度图表 Load-Temperature diagrams

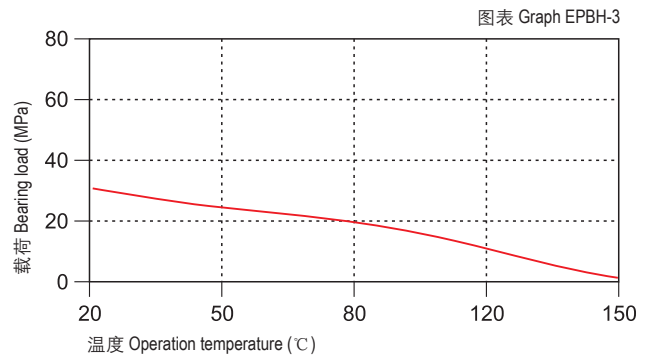

摩擦系数与速度变化关系图表 P=2MPa Coefficient of friction & the speed of bearing, p = 2 MPa

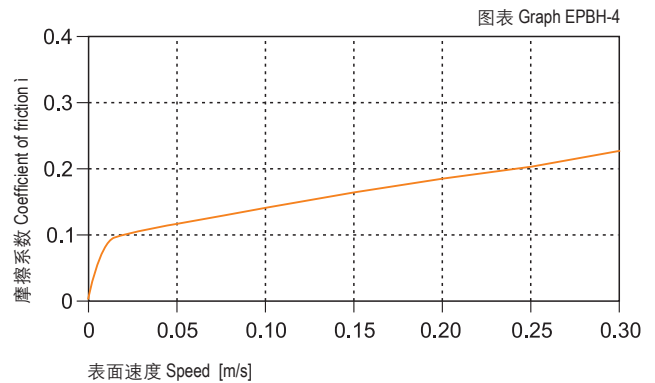

摩擦系数与载荷变化关系图表 v=0.2m/s Coefficient of friction & the pressure of bearing, v = 0.2 m/s

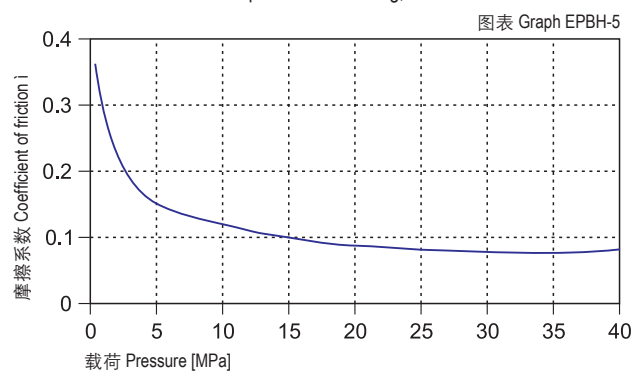

CSB-EPBH	干运行 Dry	油脂 Grease	油 Oil	水 Water
摩擦系数 μ Friction coef.	0.05~0.20	0.09	0.04	0.04

磨损与轴材料 Wearing and shaft material

轴材料对轴承的磨损有很大影响，但CSB-EPBH轴承适合几乎所有的轴材料；通过图表EPBH-7与图表EPBH-8可以看出当使用硬铬钢轴或硬化钢轴时CSB-EPBH轴承的磨损特性都非常出色。

The shaft material is an important media for the bearing wearing but CSB-EPBH is suitable for almost all kinds of shaft materials. Graph EPBH-7 and Graph EPBH-8 show that the wearing feature of CSB-EPBH is excellent when the shaft material are hardened chrome steel or hardened steel.

化学抗性 Chemical resistance

CSB-EPBH塑料轴承能抵抗弱碱、弱酸以及各类润滑油的腐蚀。

CSB-EPBH is good at chemical resistance against mild base, weak acidic medium and various kinds of lubricants.

吸水性 Water absorption

CSB-EPBH塑料轴承在标准大气中的吸湿率为0.3%。浸泡在水中最高吸水率为1.2%。较低的吸水率只有在极端应用中才需要更改轴承设计。

The moisture absorption of CSB-EPBH plastic bearings is 0.3% in standard atmosphere. The max. water absorption is 1.2% in water. These values are so low that design changes due to absorption are only necessary in extreme applications.

抗UV性能 UV resistance

CSB-EPBH塑料轴承长久暴露在紫外线下颜色基本不会改变。材料的硬度、抗压强度和耐磨性都不会改变。

CSB-EPBH can maintain its color unchanged when it is exposed into the UV ray. The hardness, Compressive strength and wear resistance of the material is also stable under such condition.

安装公差 Installation tolerances

CSB-EPBH塑料轴承压装后公差 Tolerances after pressfit

直径 Di. [mm]	CSB-EPBH E10 [mm]	座孔 Housing H7 [mm]	轴 Shaft h9 [mm]
>0 ~ 3	+0.014 ~ +0.054	0 ~ +0.010	0 ~ -0.025
>3 ~ 6	+0.020 ~ +0.068	0 ~ +0.012	0 ~ -0.030
>6 ~ 10	+0.025 ~ +0.083	0 ~ +0.015	0 ~ -0.036
>10 ~ 18	+0.032 ~ +0.102	0 ~ +0.018	0 ~ -0.043
>18 ~ 30	+0.040 ~ +0.124	0 ~ +0.021	0 ~ -0.052
>30 ~ 50	+0.050 ~ +0.150	0 ~ +0.025	0 ~ -0.062
>50 ~ 80	+0.060 ~ +0.180	0 ~ +0.030	0 ~ -0.074
>80 ~ 120	+0.072 ~ +0.212	0 ~ +0.035	0 ~ -0.087
>120 ~ 180	+0.085 ~ +0.245	0 ~ +0.040	0 ~ -0.100

在不同轴材料上旋转时的磨损量 $p=2\text{MPa}, v=0.2\text{m/s}$

Wear under rotating with different shaft materials, $p = 2 \text{ MPa}$, $v = 0.2 \text{ m/s}$

图表 Graph EPBH-7

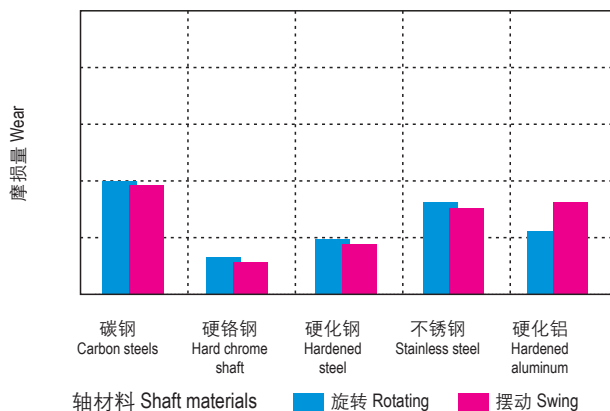

旋转磨损随轴材料与压力变化关系 $v=0.2\text{m/s}$

Wear & pressure under rotating with different shaft materials, $v = 0.2 \text{ m/s}$

图表 Graph EPBH-8

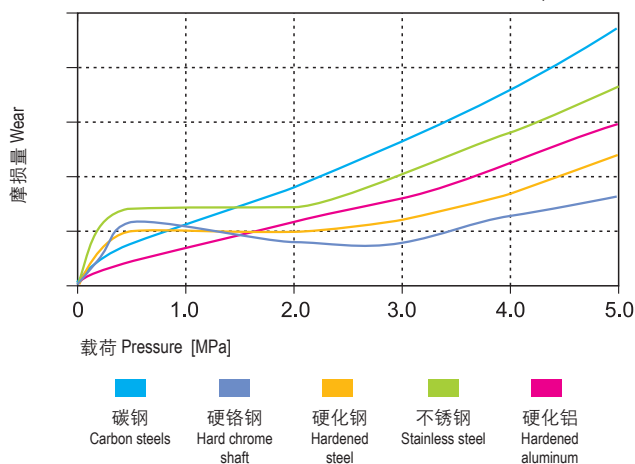

吸水性的影响 Effect of moisture absorption on EPBH bearings

图表 Graph EPBH-9

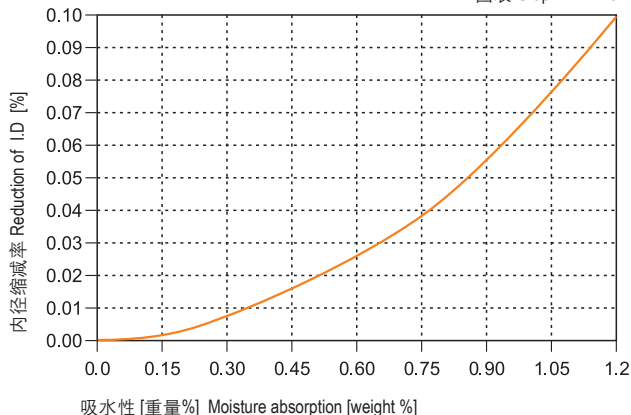



● 标准产品规格表 Standard specifications: P124

产品特性 Product features

- 低吸水率和中高承载性能。可被用于潮湿环境而耐磨性能同样出色的材料，特种金属粉末的植入使得此轴承成为可被探测的材料
- 连续使用温度: -40°C/+110°C
- 适合多数中高载荷场合
- 适合干运行、免维护
- 特殊材料优异的热传导性
- 适合低速运动
- This material is with low water absorb characteristic and high load capacity. It is widely used for the humidity condition and wear resistance requirement. The embedded special metal powder enables this material to be a detective one
- Continuous working temperature: -40°C/+110°C
- Suitable for medium and high load operation
- Maintenance-free dry operation
- Excellent thermal conductivity
- Good for low speed operation

材料数据表 Material properties data table

材料性能 Material properties	测试标准 Standard	单位 Unit	CSB-EPB1
颜色 Color	-	-	棕色 Brown
密度 Density	ISO1183	g/cm ³	1.53
最大吸湿率 Max. moisture absorption, 50%RH	ISO62	%	0.2
最大吸水率 Max. water absorption	ISO62	%	0.5
对钢动摩擦系数 Coefficient of sliding friction(steel)	ITS025	μ	0.08-0.20
极限PV值 Max. PV value	ITS026	N/mm ² × m/s	0.50
弯曲模量 Flexural modulus	ISO178	MPa	2600
弯曲强度 Flexural strength	ISO178	MPa	65
最大静载荷 Max. static load	ITS027	MPa	55
最大动载荷 Max. dynamic load	ITS028	MPa	21
邵氏硬度 Shore hardness	ISO868	D	72
连续运行温度 Long-term application temperature	ITS029	°C	+110
短时运行温度 Short-term application temperature	ITS029	°C	+160
最低运行温度 Lowest application temperature	ITS029	°C	-40
导热性 Thermal conductivity	ISO22007	W/m/K	0.26
线性热膨胀系数 Coefficient of thermal expansion	ISO11359	K ⁻¹ × 10 ⁻⁵	8
阻燃等级 Flammability	UL94	Class	HB
体电阻率 Volume resistance	IEC60093	Ω · cm	>10 ¹¹
面电阻率 Surface resistance	IEC60093	Ω	>10 ¹⁰

*ITS: CSB内部测试标准 CSB company's internal test standards.

**除非特殊说明测试温度为23°C Test temperatures are 23°C unless otherwise stated.

轴承PV值 PV value

CSB-EPB1塑料轴承最大运行PV值为0.5N/mm² × m/s; 由此决定轴承所承受的载荷与速度成反比, 详细查阅图表EPB1-1。

The max PV value of the CSB-EPB1 plastic bearings is 0.5N/mm² × m/s which determines the load capacity of bearing is inversely proportional to the speed. Please refer to the chart for more detailed information (Graph EPB1-1).

■ PV图表 Permissible PV value for CSB-EPB1

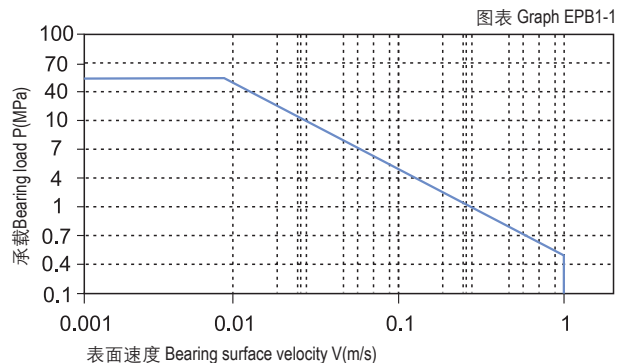

轴承的载荷、速度、温度 Load, speed and temperature

CSB-EPB1塑料轴承可承受最大静载荷为55Mpa，在此载荷下轴承的最大压缩变形量参考图表EPB1-2，轴承实际工作载荷略小于55Mpa，载荷还受到运行速度以及温度的影响，速度越快（Vmax: 1.0m/s）会导致摩擦温度上升，而温度上升（Tmax: 110℃）会导致轴承的承载能力逐渐减弱，载荷随轴承工作温度变化情况参考图表EPB1-3。

CSB-EPB1 allows the Max static load of 55Mpa, The max compressive deformation rate under the max load is listed in Graph EPB1-2, The actual load capacity of bearing is slightly less than 55Mpa, The bearing load is variable against the speed and temperature, Fast speed (Vmax: 1.0m/s) results into higher temperature (Tmax: 110℃) which decreases the load capacity of the bearing. Please refer to the Graph EPB1-3 for such variation.

轴承的摩擦系数、磨损、轴材料 Friction factor, wear and shaft material

摩擦系数 Friction factor

图EPB1-4表明CSB-EPB1塑料轴承和大多数滑动轴承一样在载荷保持不变的情况下摩擦系数会随着转速的增加略有升高；图EPB1-5表明CSB-EPB1塑料轴承摩擦系数在速度保持不变的情况下随着载荷的增加而逐步降低；图EPB1-6表明CSB-EPB1塑料轴承最适合的轴表面粗糙度为Ra0.2~0.6 μ m，轴过于光滑或者过于粗糙都会导致摩擦系数升高。

Graph EPB1-4 shows that as the same as most of the slide bearing materials, the friction factor of CSB-EPB1 is increasing along with the rotation speed under a certain loading while as shown in figure EPB1-5, it is decreased along with the increasing of loading when the operation speed is stable. From figure EPB1-6, it is found that the most suitable shaft roughness is Ra0.2 to Ra0.6. Smoother shaft or rougher shaft may result into friction factor increasing.

摩擦系数与轴表面粗糙度关系图表

Coefficient of friction & the surface roughness of shaft

图表 Graph EPB1-6

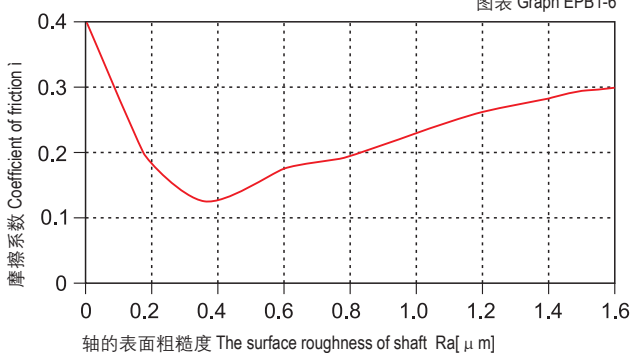

载荷-温度-变形量图表 Load-Temperature deformation

图表 Graph EPB1-2

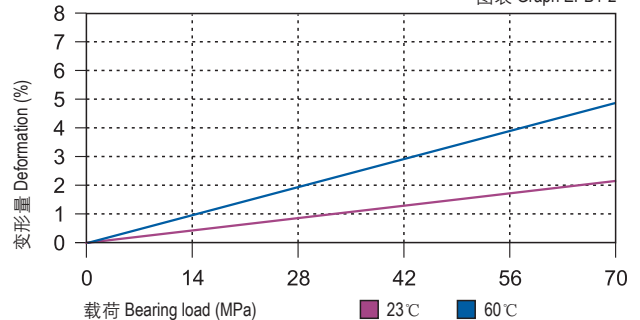

载荷-温度图表 Load-Temperature diagrams

图表 Graph EPB1-3

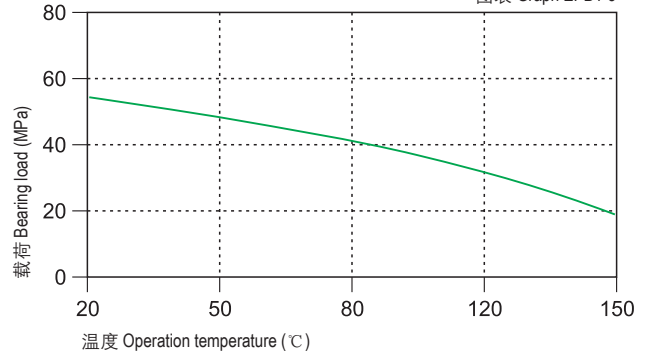

摩擦系数与速度变化关系图表 P=2MPa

Coefficient of friction & the speed of bearing, p = 2 MPa

图表 Graph EPB1-4

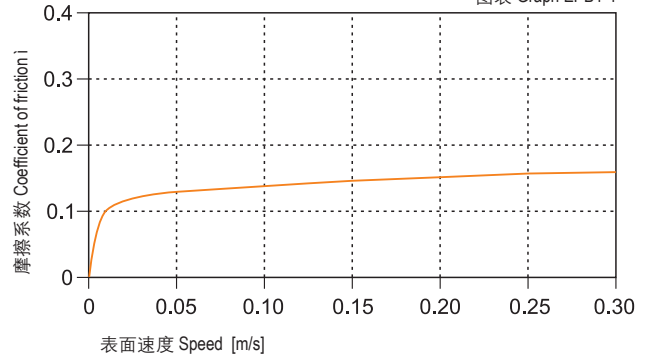

摩擦系数与载荷变化关系图表 v=0.2m/s

Coefficient of friction & the pressure of bearing, v = 0.2 m/s

图表 Graph EPB1-5

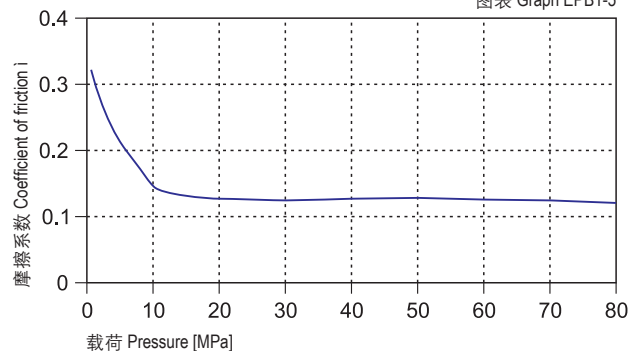

CSB-EPB1	干运行 Dry	油脂 Grease	油 Oil	水 Water
摩擦系数 μ Friction coef.	0.08~0.20	0.09	0.04	0.04

磨损与轴材料 Wearing and shaft material

图EPB1-8都表明CSB-EPB1塑料轴承的磨损受轴材料影响比较大，硬化钢轴和碳钢轴比较适合此轴承。CSB-EPB1塑料轴承在摆动运动时选择硬铬钢轴和硬化钢轴比较适合，在旋转运动中也是选择硬铬钢轴和硬化钢轴比较理想。

Graph EPB1-8 shows the wearing is considerably affected by the shaft materials. Heat-treated steel shaft and carbon steel shaft is good for this bearing material. CSB-EPB1 is suitable for hardened chrome steel and hardened steel shaft in oscillation operation and is suitable for hardened chrome steel and hardened steel shaft in rotation operation.

化学抗性 Chemical resistance

CSB-EPB1塑料轴承能抵抗部分弱酸以及各类润滑油的腐蚀。CSB-EPB1 is good at chemical resistance against weak acidic medium and various kinds of lubricants.

吸水性 Water absorption

CSB-EPB1塑料轴承在标准大气中的吸湿率为0.2%。浸泡在水中的最高吸水率为0.5%。极低吸水率不会导致轴承发生性能和尺寸变化，非常适合用于潮湿环境。

The moisture absorption of CSB-EPB1 plastic plain bearings is 0.2% in standard atmosphere. The max. water absorption is 0.5% in water. These values are very low, CSB-EPB1 plastic plain bearings is very well suited for used in wet applications.

抗UV性能 UV resistance

CSB-EPB1塑料轴承长久暴露在紫外线下颜色会发生褪变。材料性能会有所下降。

Disintegration could be possible for the material CSB-EPB1 after long period of exposing under the UV ray and therefore the performance of the material will be reduced.

安装公差 Installation tolerances

CSB-EPB1塑料轴承压装后公差 Tolerances after pressfit

直径 Di. [mm]	CSB-EPB1 E10 [mm]	座孔 Housing H7 [mm]	轴 Shaft h9 [mm]
>0 ~ 3	+0.014 ~ +0.054	0 ~ +0.010	0 ~ -0.025
>3 ~ 6	+0.020 ~ +0.068	0 ~ +0.012	0 ~ -0.030
>6 ~ 10	+0.025 ~ +0.083	0 ~ +0.015	0 ~ -0.036
>10 ~ 18	+0.032 ~ +0.102	0 ~ +0.018	0 ~ -0.043
>18 ~ 30	+0.040 ~ +0.124	0 ~ +0.021	0 ~ -0.052
>30 ~ 50	+0.050 ~ +0.150	0 ~ +0.025	0 ~ -0.062
>50 ~ 80	+0.060 ~ +0.180	0 ~ +0.030	0 ~ -0.074
>80 ~ 120	+0.072 ~ +0.212	0 ~ +0.035	0 ~ -0.087
>120 ~ 180	+0.085 ~ +0.245	0 ~ +0.040	0 ~ -0.100

在不同轴材料上旋转时的磨损量 $p=2\text{MPa}$, $v=0.2\text{m/s}$
Wear under rotating with different shaft materials, $p = 2 \text{ MPa}$, $v = 0.2 \text{ m/s}$

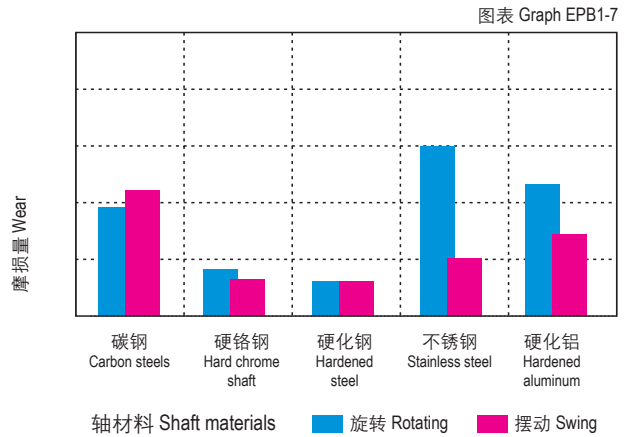

旋转磨损随轴材料与压力变化关系 $v=0.2\text{m/s}$
Wear & pressure under rotating with different shaft materials, $v = 0.2 \text{ m/s}$

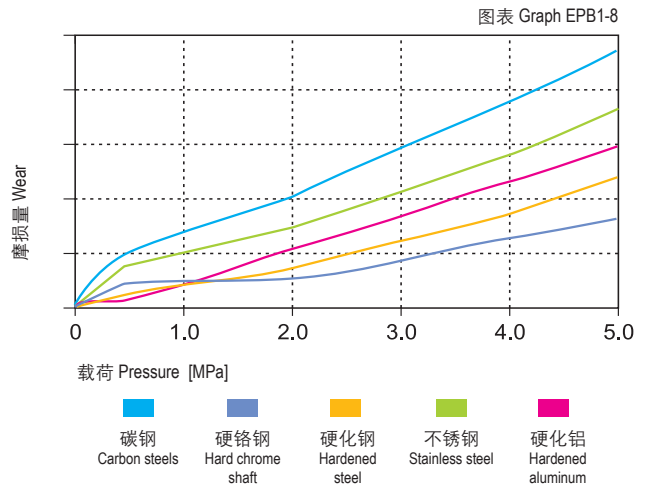

吸水性的影响 Effect of moisture absorption on EPB1 bearings

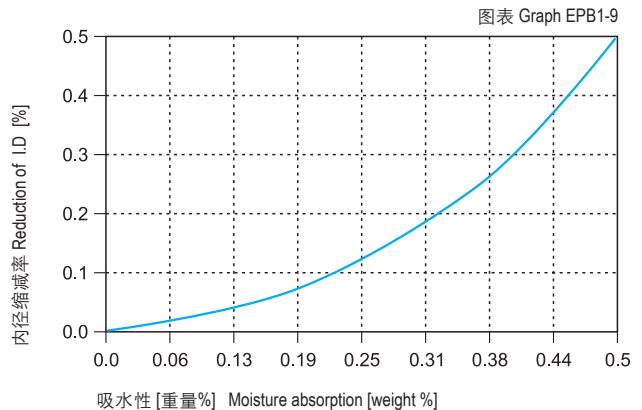



● 标准产品规格表 Standard specifications: P124

产品特性 Product features

- 中低载荷应用的低成本解决方案，同时此材料具有低吸水性特性
- 连续使用温度: -40℃/+100℃
- 适用于中低载荷
- 适合干运行免维护
- 潮湿环境应用
- 大批量、低成本
- The solution of middle to low load application and economic effective requirement. It is also one of the low water absorbing materials
- Continuous working temperature: -40℃/+100℃
- Suitable for medium load operation
- Maintenance-free dry operation
- For wet conditions
- Low cost material for high quantities

材料数据表 Material properties data table

材料性能 Material properties	测试标准 Standard	单位 Unit	CSB-EPB2
颜色 Color	-	-	橄榄绿 Olive
密度 Density	ISO1183	g/cm ³	1.39
最大吸湿率 Max. moisture absorption, 50%RH	ISO62	%	0.2
最大吸水率 Max. water absorption	ISO62	%	0.4
对钢动摩擦系数 Coefficient of sliding friction(steel)	ITS025	μ	0.07-0.20
极限PV值 Max. PV value	ITS026	N/mm ² × m/s	0.45
弯曲模量 Flexural modulus	ISO178	MPa	2400
弯曲强度 Flexural strength	ISO178	MPa	60
最大静载荷 Max. static load	ITS027	MPa	50
最大动载荷 Max. dynamic load	ITS028	MPa	19
邵氏硬度 Shore hardness	ISO868	D	72
连续运行温度 Long-term application temperature	ITS029	℃	+100
短时运行温度 Short-term application temperature	ITS029	℃	+150
最低运行温度 Lowest application temperature	ITS029	℃	-40
导热性 Thermal conductivity	ISO22007	W/m/K	0.25
线性热膨胀系数 Coefficient of thermal expansion	ISO11359	K ⁻¹ × 10 ⁻⁵	10
阻燃等级 Flammability	UL94	Class	HB
体电阻率 Volume resistance	IEC60093	Ω · cm	>10 ¹²
面电阻率 Surface resistance	IEC60093	Ω	>10 ¹¹

*ITS: CSB内部测试标准 CSB company's internal test standards.

**除非特殊说明测试温度为23℃ Test temperatures are 23℃ unless otherwise stated.

轴承PV值 PV value

CSB-EPB2塑料轴承最大运行PV值为0.45N/mm² × m/s; 由此决定轴承所承受的载荷与速度成反比, 详细查阅图表EPB2-1。

The max PV value of the CSB-EPB2 plastic bearings is 0.45N/mm² × m/s which determines the load capacity of bearing is inversely proportional to the speed. Please refer to the chart for more detailed information (Graph EPB2-1).

■ PV图表 Permissible PV value for CSB-EPB2

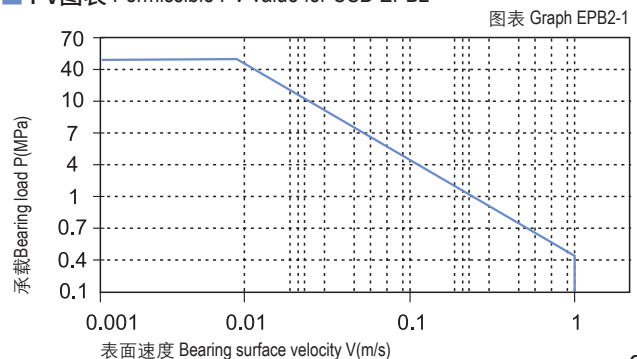

轴承的载荷、速度、温度 Load, speed and temperature

CSB-EPB2塑料轴承可承受最大静载荷为50Mpa，在此载荷下轴承的最大压缩变形量参考图表EPB2-2，轴承实际工作载荷略小于50Mpa，载荷还受到运行速度以及温度的影响，速度越快（Vmax: 1.0m/s）会导致摩擦温度上升，而温度上升（Tmax: 100℃）会导致轴承的承载能力逐渐减弱，载荷随轴承工作温度变化情况参考图表EPB2-3。

CSB-EPB2 allows the Max static load of 50Mpa, The max compressive deformation rate under the max load is listed in Graph EPB2-2, The actual load capacity of bearing is slightly less than 50Mpa, The bearing load is variable against the speed and temperature, Fast speed (Vmax: 1.0m/s) results into higher temperature (Tmax: 100℃) which decreases the load capacity of the bearing. Please refer to the Graph EPB2-3 for such variation.

轴承的摩擦系数、磨损、轴材料 Friction factor, wear and shaft material

摩擦系数 Friction factor

与其它塑料轴承基本一样，图EPB2-4表明CSB-EPB2塑料轴承在载荷保持不变的情况下摩擦系数随着运行速度的增加而升高；图EPB2-5表明CSB-EPB2塑料轴承在保持速度不变时摩擦系数随着载荷的增加而逐步减低。根据图EPB2-6表明CSB-EPB2塑料轴承的摩擦系数会随着轴表面粗糙度的变化而不同，我们推荐使用轴粗糙度为Ra0.3~0.6μm；

Similar with most of the plastic bearings, the friction factor of CSB-EPB2 is increased along with the operation speed when the loading is stable (see Graph EPB2-4) and is decreased along with the loading increasing when the operation speed is stable (see Graph EPB2-5). From Graph EPB2-6, it shows the friction factor of CSB-EPB2 is variable against different shaft surface roughness. The recommended shaft surface roughness is Ra0.3~0.6.

摩擦系数与轴表面粗糙度关系图表

Coefficient of friction & the surface roughness of shaft

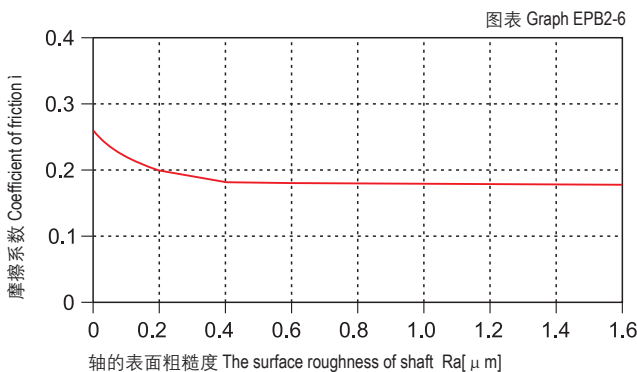

载荷-温度-变形量图表 Load-Temperature deformation

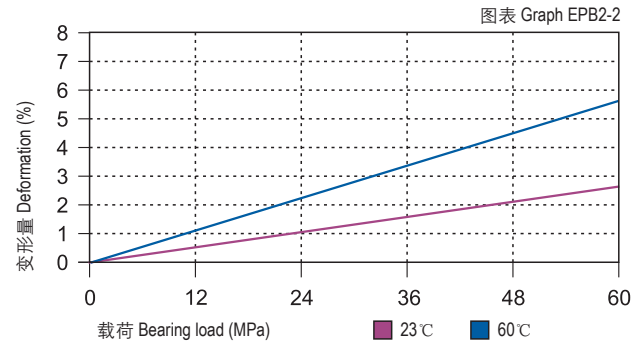

载荷-温度图表 Load-Temperature diagrams

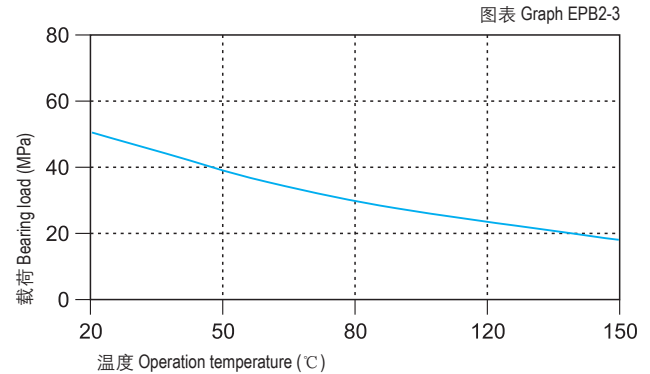

摩擦系数与速度变化关系图表 P=2MPa

Coefficient of friction & the speed of bearing, p = 2 MPa

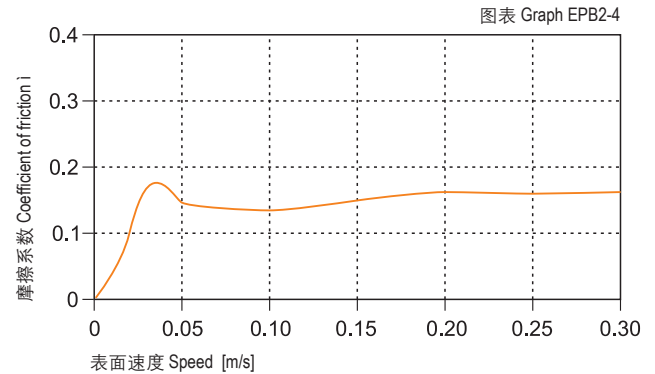

摩擦系数与载荷变化关系图表 v=0.2m/s

Coefficient of friction & the pressure of bearing, v = 0.2 m/s

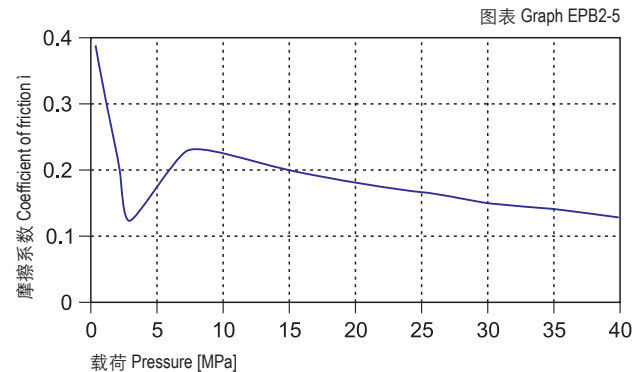

CSB-EPB2	干运行 Dry	油脂 Grease	油 Oil	水 Water
摩擦系数 μ Friction coef.	0.07~0.20	0.09	0.04	0.04

磨损与轴材料 Wearing and shaft material

图EPB2-8表明低载时硬化钢轴与硬铬钢轴比较适合用于CSB-EPB2塑料轴承。CSB-EPB2塑料轴承在用于摆动运动时磨损值明显要优越于用于旋转运动。

Graph EPB2-8 shows that CSB-EPB2 is rather suitable for hardened steel shaft and hardened chrome steel shaft under lower loading and Graph EPB2-7 shows that CSB-EPB2 wearing feature is better for oscillation operation than of rotation operation.

化学抗性 Chemical resistance

CSB-EPB2塑料轴承能抵抗部分弱酸以及各类润滑油的腐蚀。

CSB-EPB2 is good at chemical resistance against weak acidic medium and various kinds of lubricants.

吸水性 Water absorption

CSB-EPB2塑料轴承在标准大气中的吸湿率为0.2%。浸泡在水中的最高吸水率为0.4%。极低吸水率不会导致轴承发生性能和尺寸变化，非常适合用于潮湿环境。

The moisture absorption of CSB-EPB2 plastic plain bearings is 0.2% in standard atmosphere. The max. water absorption is 0.4% in water. These values are very low, CSB-EPB2 plastic plain bearings are very well suited for used in wet applications.

抗UV性能 UV resistance

CSB-EPB2塑料轴承长久暴露在紫外线下颜色会发生褪变。材料性能会有所下降。

Disintegration could be possible for the material CSB-EPB2 after long period of exposing under the UV ray and therefore the performance of the material will be reduced.

安装公差 Installation tolerances

CSB-EPB2塑料轴承压装后公差 Tolerances after pressfit

直径 Di. [mm]	CSB-EPB2 E10 [mm]	座孔 Housing H7 [mm]	轴 Shaft h9 [mm]
>0 ~ 3	+0.014 ~ +0.054	0 ~ +0.010	0 ~ -0.025
>3 ~ 6	+0.020 ~ +0.068	0 ~ +0.012	0 ~ -0.030
>6 ~ 10	+0.025 ~ +0.083	0 ~ +0.015	0 ~ -0.036
>10 ~ 18	+0.032 ~ +0.102	0 ~ +0.018	0 ~ -0.043
>18 ~ 30	+0.040 ~ +0.124	0 ~ +0.021	0 ~ -0.052
>30 ~ 50	+0.050 ~ +0.150	0 ~ +0.025	0 ~ -0.062
>50 ~ 80	+0.060 ~ +0.180	0 ~ +0.030	0 ~ -0.074
>80 ~ 120	+0.072 ~ +0.212	0 ~ +0.035	0 ~ -0.087
>120 ~ 180	+0.085 ~ +0.245	0 ~ +0.040	0 ~ -0.100

在不同轴材料上旋转时的磨损量 $p=2\text{MPa}$, $v=0.2\text{m/s}$

Wear under rotating with different shaft materials, $p = 2 \text{ MPa}$, $v = 0.2 \text{ m/s}$

图表 Graph EPB2-7

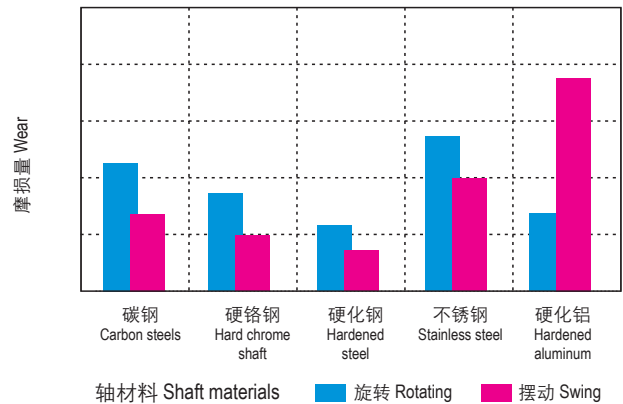

旋转磨损随轴材料与压力变化关系 $v=0.2\text{m/s}$

Wear & pressure under rotating with different shaft materials, $v = 0.2 \text{ m/s}$

图表 Graph EPB2-8

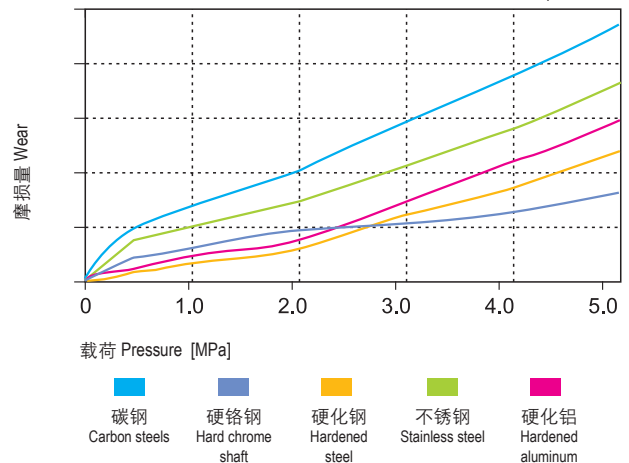

吸水性的影响

Effect of moisture absorption on EPB2 bearings

图表 Graph EPB2-9

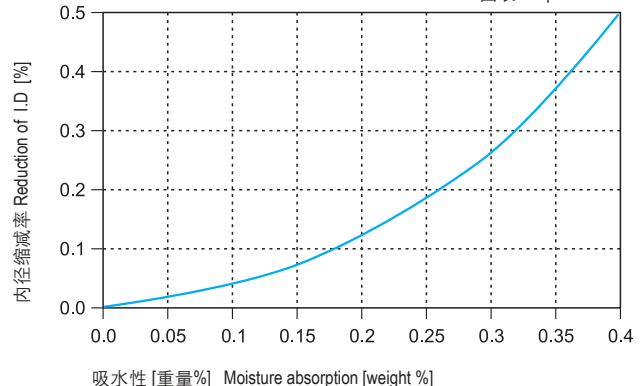

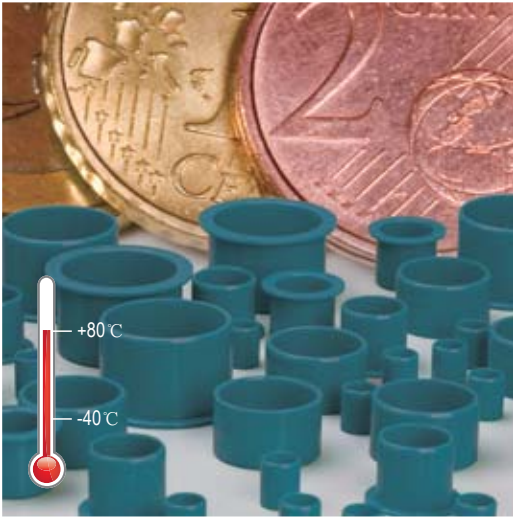

● 标准产品规格表 Standard specifications: P124

产品特性 Product features

- 中低载荷和速度的优化组合，不含PTFE；大批量低成本需求
- 连续使用温度：-40℃/+80℃
- 适合多数低载荷场合
- 适合干运行、免维护
- 不同轴材料磨损很小
- 较低的摩擦系数
- The combination of middle to low load and low speed application requirement. It is a material without PTFE embedded for the low cost and big quantity demanding
- Continuous working temperature: -40℃/+80℃
- Very common; suitable for most average and low load
- Maintenance-free dry operation
- Light wear against different shaft materials
- Low friction

材料数据表 Material properties data table

材料性能 Material properties	测试标准 Standard	单位 Unit	CSB-EPB2D
颜色 Color	-	-	绿色 Green
密度 Density	ISO1183	g/cm ³	1.40
最大吸湿率 Max. moisture absorption, 50%RH	ISO62	%	0.3
最大吸水率 Max. water absorption	ISO62	%	1.2
对钢动摩擦系数 Coefficient of sliding friction(steel)	ITS025	μ	0.05-0.25
极限PV值 Max. PV value	ITS026	N/mm ² × m/s	0.25
弯曲模量 Flexural modulus	ISO178	MPa	2000
弯曲强度 Flexural strength	ISO178	MPa	65
最大静载荷 Max. static load	ITS027	MPa	30
最大动载荷 Max. dynamic load	ITS028	MPa	13
邵氏硬度 Shore hardness	ISO868	D	75
连续运行温度 Long-term application temperature	ITS029	℃	+80
短时运行温度 Short-term application temperature	ITS029	℃	+120
最低运行温度 Lowest application temperature	ITS029	℃	-40
导热性 Thermal conductivity	ISO22007	W/m/K	0.25
线性热膨胀系数 Coefficient of thermal expansion	ISO11359	K ⁻¹ × 10 ⁻⁵	11
阻燃等级 Flammability	UL94	Class	HB
体电阻率 Volume resistance	IEC60093	Ω · cm	>10 ¹³
面电阻率 Surface resistance	IEC60093	Ω	>10 ¹²

*ITS: CSB内部测试标准 CSB company's internal test standards.

**除非特殊说明测试温度为23℃ Test temperatures are 23℃ unless otherwise stated.

轴承PV值 PV value

CSB-EPB2D塑料轴承最大运行PV值为0.25N/mm² × m/s；由此决定轴承所承受的载荷与速度成反比，详细查阅图表EPB2D-1。

The max PV value of the CSB-EPB2D plastic bearings is 0.25N/mm² × m/s which determines the load capacity of bearing is inversely proportional to the speed. Please refer to the chart for more detailed information (Graph EPB2D-1).

■ PV图表 Permissible PV value for CSB-EPB2D

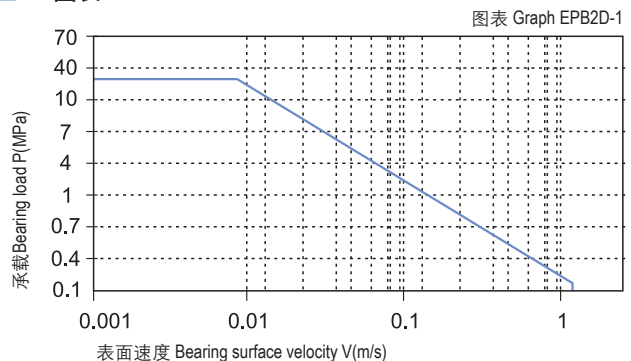

轴承的载荷、速度、温度 Load, speed and temperature

CSB-EPB2D塑料轴承可承受最大静载荷为30Mpa，在此载荷下轴承的最大压缩变形量参考图表EPB2D-2，轴承实际工作载荷略小于30Mpa，载荷还受到运行速度以及温度的影响，速度越快（Vmax: 1.2m/s）会导致摩擦温度上升，而温度上升（Tmax: 80℃）会导致轴承的承载能力逐渐减弱，载荷随轴承工作温度变化情况参考图表EPB2D-3。

CSB-EPB2D allows the Max static load of 30Mpa, The max compressive deformation rate under the max load is listed in Graph EPB2D-2, The actual load capacity of bearing is slightly less than 30Mpa, The bearing load is variable against the speed and temperature, Fast speed (Vmax: 1.2m/s) results into higher temperature (Tmax: 80℃) which decreases the load capacity of the bearing. Please refer to the Graph EPB2D-3 for such variation.

轴承的摩擦系数、磨损、轴材料 Friction factor, wear and shaft material

摩擦系数 Friction factor

图表EPB2D-4表明CSB-EPB2D塑料轴承在载荷保持不变的情况下摩擦系数先是随着运行速度的增加而升高，当运行速度超过0.25m/s后摩擦系数反而会随着运动速度的增加而降低；图表EPB2D-5表明CSB-EPB2D塑料轴承在保持速度不变时摩擦系数随着载荷的增加而逐步减低。根据图表EPB2D-6表明CSB-EPB2D塑料轴承的摩擦系数会随着轴表面粗糙度的变化而不同，我们推荐使用轴粗糙度为Ra0.3 ~ 0.6μm；

Graph EPB2D-4 shows that the friction factor of CSB-EPB2D is initially increased along with the operation speed increasing when the loading is stable but when the speed reaches over 0.25m/s, it is decreased along with the operation speed increasing. Graph EPB2D-5 shows that the friction factor of CSB-EPB2D is decreasing along with the loading increasing when the operation speed is stable. Graph EPB2D-6 shows the friction factor of CSB-EPB2D is sensitive to the shaft roughness. The best shaft roughness for this material is Ra0.3-0.6.

摩擦系数与轴表面粗糙度关系图表

Coefficient of friction & the surface roughness of shaft

图表 Graph EPB2D-6

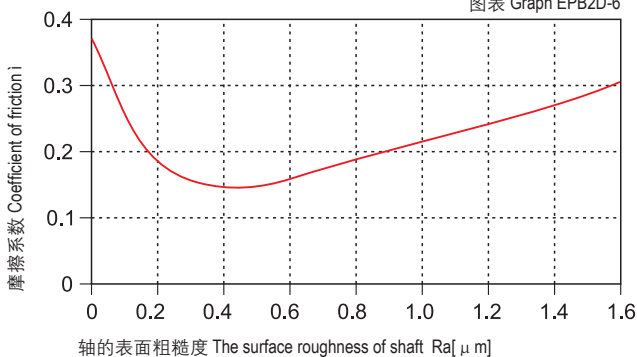

载荷-温度-变形量图表 Load-Temperature deformation

图表 Graph EPB2D-2

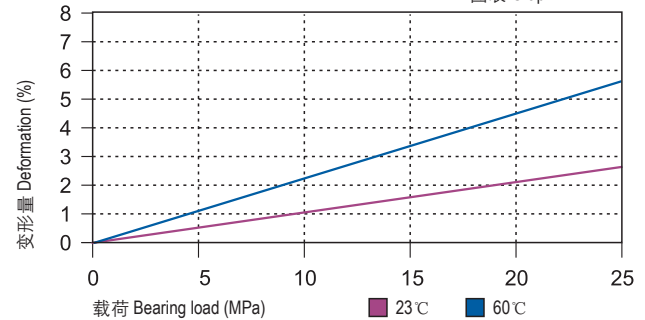

载荷-温度图表 Load-Temperature diagrams

图表 Graph EPB2D-3

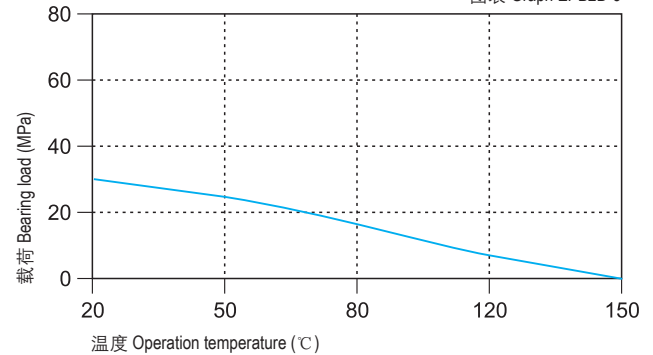

摩擦系数与速度变化关系图表 P=2MPa

Coefficient of friction & the speed of bearing, p = 2 MPa

图表 Graph EPB2D-4

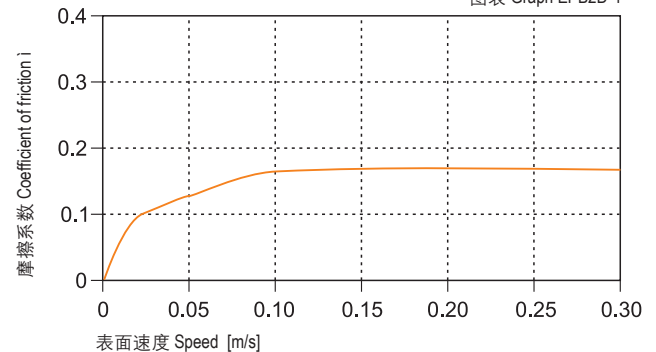

摩擦系数与载荷变化关系图表 v=0.2m/s

Coefficient of friction & the pressure of bearing, v = 0.2 m/s

图表 Graph EPB2D-5

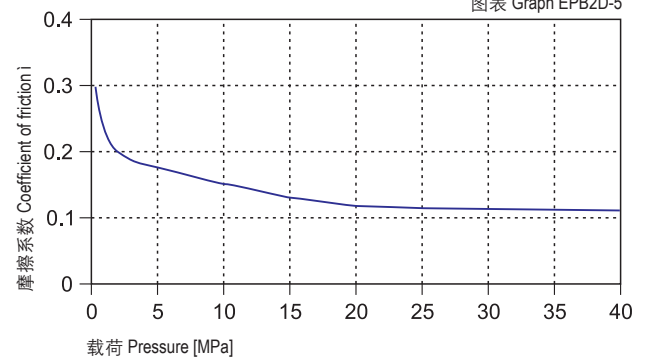

CSB-EPB2D	干运行 Dry	油脂 Grease	油 Oil	水 Water
摩擦系数 μ Friction coef.	0.05~0.25	0.09	0.04	0.04

磨损与轴材料 Wearing and shaft material

图表EPB2D-7与图表EPB2D-8表明低载时硬铬钢轴比较适合用于CSB-EPB2D塑料轴承，当载荷逐渐增大到1.0Mpa以上时不锈钢轴相对比较合适。CSB-EPB2D塑料轴承在用于旋转运动时采用硬化钢轴比较理想，而在用于摆动运动中采用硬铬钢轴相对比较合适。

Graph EPB2D-7 and Graph EPB2D-8 shows that the hardened chrome steel shaft is good for CSB-EPB2D bearings under lower loading and stainless steel shaft is better when the loading is over 1.0Mpa. Hardened steel shaft is recommended in rotation operation but hardened chrome steel shaft is recommended in oscillation operation.

化学抗性 Chemical resistance

CSB-EPB2D塑料轴承能抵抗弱碱、弱酸以及各类润滑油的腐蚀。

CSB-EPB2D is good at chemical resistance against mild base, weak acidic medium and various kinds of lubricants.

吸水性 Water absorption

CSB-EPB2D塑料轴承在标准大气中的吸湿率为0.3%。浸泡在水中最高吸水率为1.2%。较低的吸水率只有在极端应用中才需要更改轴承设计。

The moisture absorption of CSB-EPB2D plastic bearings is 0.3% in standard atmosphere. The max. water absorption is 1.2% in water. These values are so low that design changes due to absorption are only necessary in extreme applications.

抗UV性能 UV resistance

CSB-EPB2D塑料轴承长久暴露在紫外线下颜色会变浅。材料的硬度，抗压强度和耐磨性都不会改变。

The color of CSB-EPB2D will become lighter when it is exposed into the UV ray. The hardness, Compressive strength and wear resistance of the material is also stable under such condition.

安装公差 Installation tolerances

CSB-EPB2D塑料轴承压装后公差 Tolerances after pressfit

直径 Di. [mm]	CSB-EPB2D E10 [mm]	座孔 Housing H7 [mm]	轴 Shaft h9 [mm]
>0 ~ 3	+0.014 ~ +0.054	0 ~ +0.010	0 ~ -0.025
>3 ~ 6	+0.020 ~ +0.068	0 ~ +0.012	0 ~ -0.030
>6 ~ 10	+0.025 ~ +0.083	0 ~ +0.015	0 ~ -0.036
>10 ~ 18	+0.032 ~ +0.102	0 ~ +0.018	0 ~ -0.043
>18 ~ 30	+0.040 ~ +0.124	0 ~ +0.021	0 ~ -0.052
>30 ~ 50	+0.050 ~ +0.150	0 ~ +0.025	0 ~ -0.062
>50 ~ 80	+0.060 ~ +0.180	0 ~ +0.030	0 ~ -0.074
>80 ~ 120	+0.072 ~ +0.212	0 ~ +0.035	0 ~ -0.087
>120 ~ 180	+0.085 ~ +0.245	0 ~ +0.040	0 ~ -0.100

在不同轴材料上旋转时的磨损量 $p=2\text{MPa}$, $v=0.2\text{m/s}$ Wear under rotating with different shaft materials, $p = 2 \text{ MPa}$, $v = 0.2 \text{ m/s}$

图表 Graph EPB2D-7

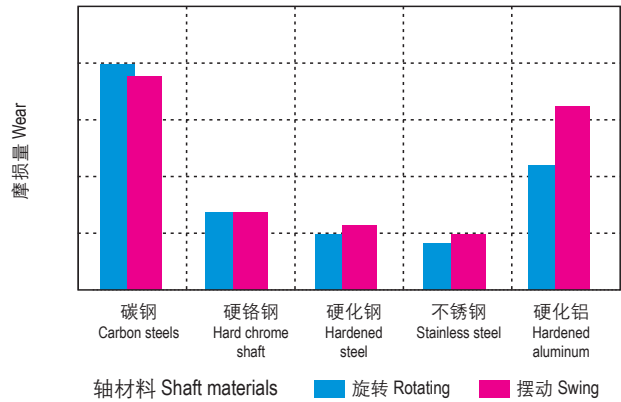

旋转磨损随轴材料与压力变化关系 $v=0.2\text{m/s}$ Wear & pressure under rotating with different shaft materials, $v = 0.2 \text{ m/s}$

Wear & pressure under rotating with different shaft materials, $v = 0.2 \text{ m/s}$

图表 Graph EPB2D-8

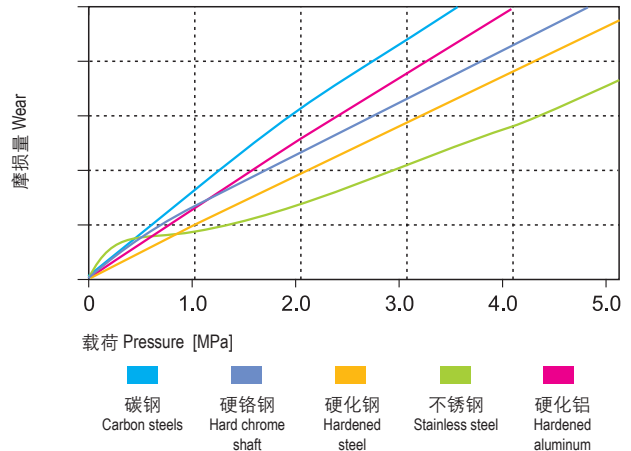

吸水性的影响 Effect of moisture absorption on EPB2D bearings

Effect of moisture absorption on EPB2D bearings

图表 Graph EPB2D-9

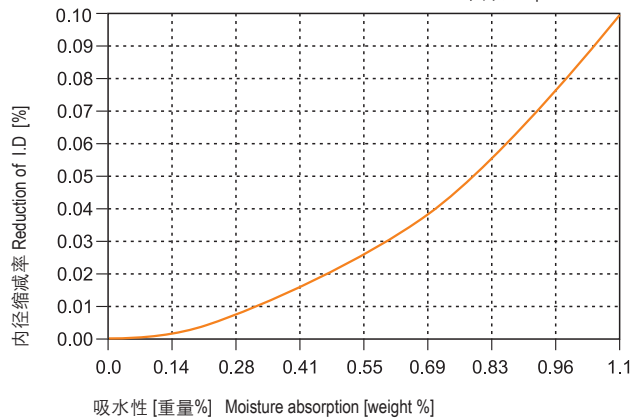



● 标准产品规格表 Standard specifications: P128

产品特性 Product features

- 中高载荷下的应用能手。作为纤维增强和润滑的结合材料，可在130度下广泛被应用
- 连续使用温度: -40℃/+130℃
- 适合中高载荷，通用性好
- 适合干运行、免维护
- 适用于不同轴材料
- 用于旋转、摆动运动
- 抗灰尘能力强
- Best for middle to high load applications. With the perfect combination of reinforced fibre and good lubrication feature, this material is suitable to be used under the temperature of 130℃
- Continuous working temperature: -40℃/+130℃
- Suitable for medium and high load operation
- Maintenance-free dry operation
- Applicable for various shaft materials
- Good for rotation and oscillating operation
- Excellent dust resistance

材料数据表 Material properties data table

材料性能 Material properties	测试标准 Standard	单位 Unit	CSB-EPB3
颜色 Color	-	-	深灰 Dark grey
密度 Density	ISO1183	g/cm ³	1.46
最大吸湿率 Max. moisture absorption, 50%RH	ISO62	%	0.7
最大吸水率 Max. water absorption	ISO62	%	4.0
对钢动摩擦系数 Coefficient of sliding friction(steel)	ITS025	μ	0.08-0.18
极限PV值 Max. PV value	ITS026	N/mm ² × m/s	0.45
弯曲模量 Flexural modulus	ISO178	MPa	8500
弯曲强度 Flexural strength	ISO178	MPa	210
最大静载荷 Max. static load	ITS027	MPa	80
最大动载荷 Max. dynamic load	ITS028	MPa	43
邵氏硬度 Shore hardness	ISO868	D	81
连续运行温度 Long-term application temperature	ITS029	℃	+130
短时运行温度 Short-term application temperature	ITS029	℃	+220
最低运行温度 Lowest application temperature	ITS029	℃	-40
导热性 Thermal conductivity	ISO22007	W/m/K	0.24
线性热膨胀系数 Coefficient of thermal expansion	ISO11359	K ⁻¹ × 10 ⁻⁵	9
阻燃等级 Flammability	UL94	Class	HB
体电阻率 Volume resistance	IEC60093	Ω · cm	>10 ¹³
面电阻率 Surface resistance	IEC60093	Ω	>10 ¹¹

*ITS: CSB内部测试标准 CSB company's internal test standards.

**除非特殊说明测试温度为23℃ Test temperatures are 23℃ unless otherwise stated.

轴承PV值 PV value

CSB-EPB3塑料轴承最大运行PV值为0.45N/mm² × m/s; 由此决定轴承所承受的载荷与速度成反比, 详细查阅图表EPB3-1。

The max PV value of the CSB-EPB3 plastic bearings is 0.45N/mm² × m/s which determines the load capacity of bearing is inversely proportional to the speed. Please refer to the chart for more detailed information (Graph EPB3-1).

■ PV图表 Permissible PV value for CSB-EPB3

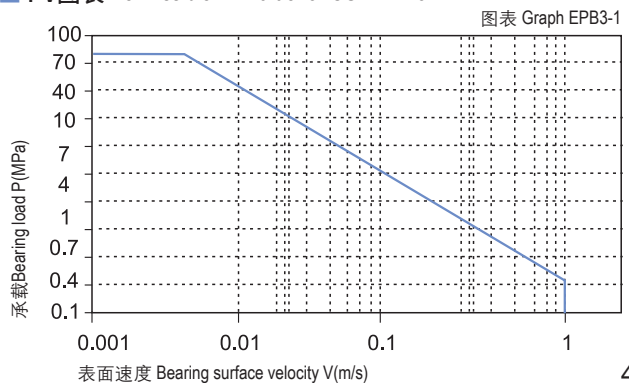

轴承的载荷、速度、温度 Load, speed and temperature

CSB-EPB3塑料轴承可承受最大静载荷为80Mpa，在此载荷下轴承的最大压缩变形量参考图表EPB3-2，轴承实际工作载荷略小于80Mpa，载荷还受到运行速度以及温度的影响，速度越快 (Vmax: 1.0m/s) 会导致摩擦温度上升，而温度上升 (Tmax: 130℃) 会导致轴承的承载能力逐渐减弱，载荷随轴承工作温度变化情况参考图表EPB3-3。

CSB-EPB3 allows the Max static load of 80Mpa, The max compressive deformation rate under the max load is listed in Graph EPB3-2, The actual load capacity of bearing is slightly less than 80Mpa, The bearing load is variable against the speed and temperature, Fast speed (Vmax: 1.0m/s) results into higher temperature (Tmax: 130℃) which decreases the load capacity of the bearing. Please refer to the Graph EPB3-3 for such variation.

轴承的摩擦系数、磨损、轴材料 Friction factor, wear and shaft material

摩擦系数 Friction factor

滑动轴承的摩擦系数与轴承的载荷、运行速度以及轴材料表面粗糙度都息息相关；CSB-EPB3塑料轴承的摩擦系数随着载荷的增加而降低（图表EPB3-5），随着运行速度的增加而升高（图表EPB3-4）；这就表明EPB3塑料轴承适用于高载低速的应用场合；而轴表面粗糙度越光滑或者越粗糙都会导致轴承的摩擦系数增加，CSB-EPB3塑料轴承推荐的表面粗糙度是在Ra0.5 ~ Ra0.8（图表EPB3-6）。

The friction factor of the sliding bearings is relative to the bearing load, operation speed and the roughness of the shaft material. CSB-EPB3 Bearing Friction factor decreased along with the increasing of the loading (See Graph EPB3-5) and increased along with the increasing of the operation speed (See Graph EPB3-4). The above feature induces the CSB-EPB3 material is applicable for the high load and low speed operation while too smooth and too rough surface may result into the increasing of friction factor. The recommended surface roughness of CSB-EPB3 is Ra0.5~Ra0.8 (See Graph EPB3-6).

■ 载荷-温度-变形量图表 Load-Temperature deformation

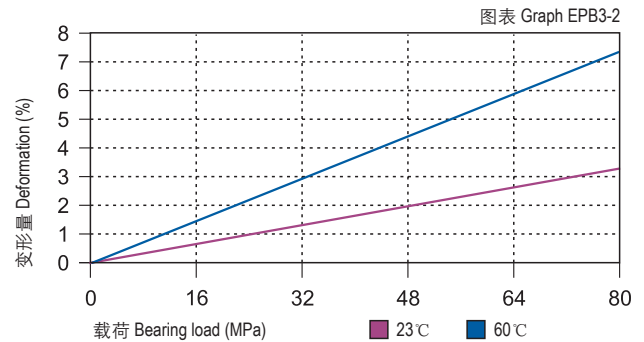

■ 载荷-温度图表 Load-Temperature diagrams

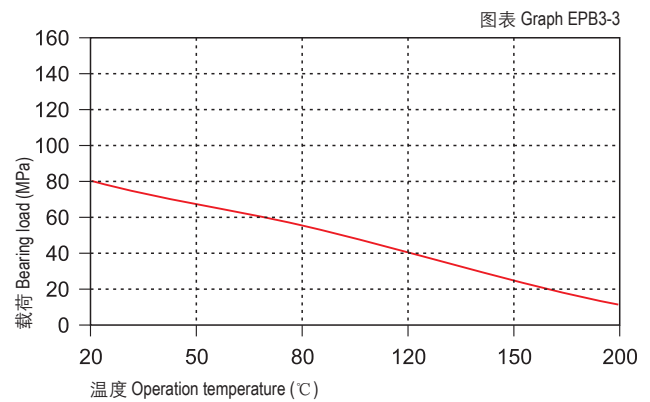

■ 摩擦系数与速度变化关系图表 P=2MPa Coefficient of friction & the speed of bearing, p = 2 MPa

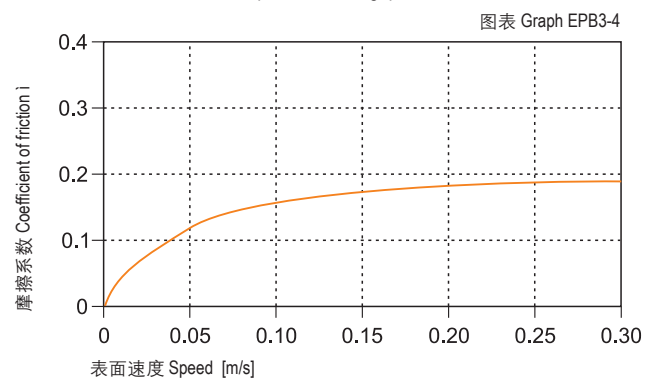

■ 摩擦系数与轴表面粗糙度关系图表 Coefficient of friction & the surface roughness of shaft

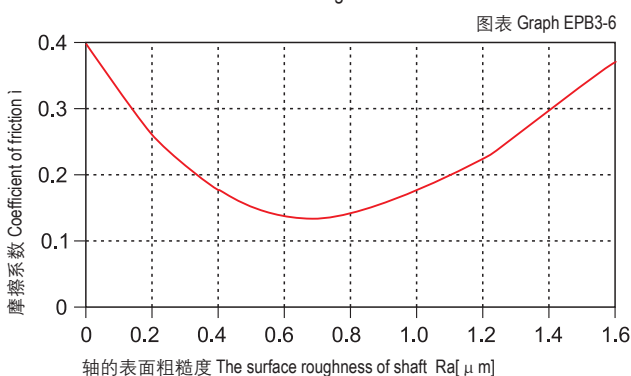

■ 摩擦系数与载荷变化关系图表 v=0.2m/s Coefficient of friction & the pressure of bearing, v = 0.2 m/s

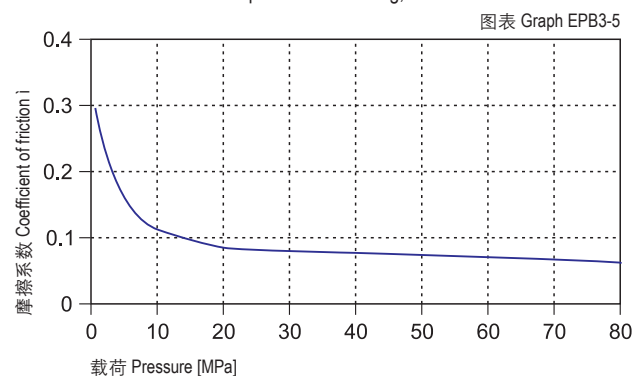

CSB-EPB3	干运行 Dry	油脂 Grease	油 Oil	水 Water
摩擦系数 μ Friction coef.	0.08-0.18	0.09	0.04	0.04

磨损与轴材料 Wearing and shaft material

通过轴承在不同轴上的测试表明CSB-EPB3塑料轴承低载时在碳钢轴和硬铬轴运行性能更好（见图表EPB3-7和图表EPB3-8）；当然，随着轴承承受载荷的增加，对轴硬度要求也越高；较软的轴容易先产生磨损，导致轴承磨损也随之加大。当轴承的载荷超过2Mpa时，轴承的磨损会随着轴硬度的增加而随之减少。图表EPB3-7表明CSB-EPB3在摆动运动下的效果要好于旋转运动，在同等工况条件下摆动运动下的磨损要小于旋转运动，特别是在高载荷下这种趋势就越明显。

Test of the bearing against various shaft materials shows that the material CSB-EPB3 features the best performance where the shaft material is carbon steel and hard chrome steel under low loading. (See Graph EPB3-7 and Graph EPB3-8). Therefore, the higher the load is, the more critical the hardness of the shaft will have to be. The softer shaft will be worn off sooner and as a result, the bearing wearing will be increased. But when the loading is increased over 2Mpa, the wearing of the bearing will be better along with the increasing of the shaft hardness.

Refer to Graph EPB3-7 It shows that the material CSB-EPB3 is better under the oscillation operation comparing with the rotation operation. Under the same condition, the wearing feature of the oscillation operation is much better than that of the rotation operation. This feature is sharply improved under higher loading.

化学抗性 Chemical resistance

CSB-EPB3塑料轴承能抵抗弱碱以及各类润滑油的腐蚀。CSB-EPB3 is good at chemical resistance against weak acidic medium and various kinds of lubricants.

吸水性 Water absorption

CSB-EPB3塑料轴承在标准大气中的吸湿率为0.7%。浸泡在水中最高吸水率为4.0%。由于高吸水率的特性，我们必须考虑此轴承的应用环境。

The moisture absorption of CSB-EPB3 plastic plain bearings is 0.7% in standard atmosphere. The max. water absorption is 4.0% in water. The application environment has to be considered due to the high water absorption properties.

抗UV性能 UV resistance

CSB-EPB3塑料轴承长久暴露在紫外线下颜色基本不会改变。材料性能基本都不会发生改变。

CSB-EPB3 can maintain its color unchanged when it is exposed into the UV ray. The material performance stays stable.

安装公差 Installation tolerances

CSB-EPB3塑料轴承压装后公差 Tolerances after pressfit

● 标准产品规格表 Standard specifications: P128

■ 在不同轴材料上旋转时的磨损量 $p=2\text{MPa}$, $v=0.2\text{m/s}$
Wear under rotating with different shaft materials, $p = 2 \text{ MPa}$, $v = 0.2 \text{ m/s}$

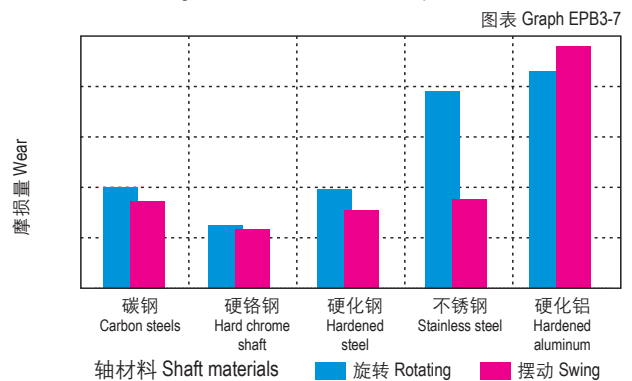

■ 旋转磨损随轴材料与压力变化关系 $v=0.2\text{m/s}$
Wear & pressure under rotating with different shaft materials, $v = 0.2 \text{ m/s}$

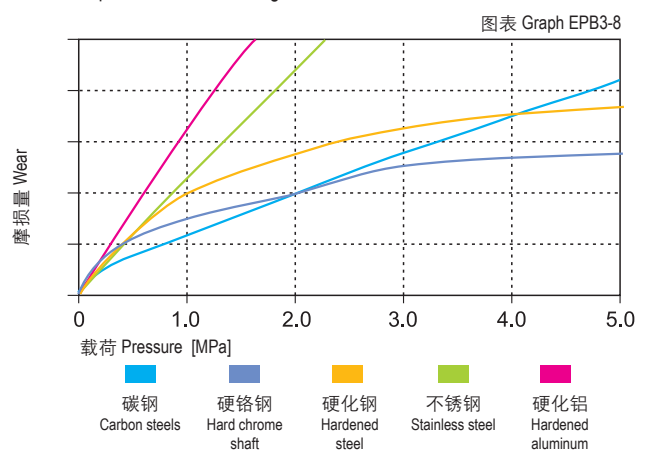

■ 吸水性的影响 Effect of moisture absorption on EPB3 bearings

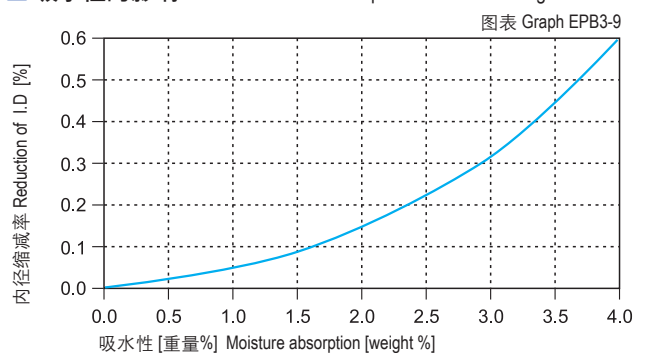

直径 Di. [mm]	CSB-EPB3 E10 [mm]	座孔 Housing H7 [mm]	轴 Shaft h9 [mm]
>0 ~ 3	+0.014 ~ +0.054	0 ~ +0.010	0 ~ -0.025
>3 ~ 6	+0.020 ~ +0.068	0 ~ +0.012	0 ~ -0.030
>6 ~ 10	+0.025 ~ +0.083	0 ~ +0.015	0 ~ -0.036
>10 ~ 18	+0.032 ~ +0.102	0 ~ +0.018	0 ~ -0.043
>18 ~ 30	+0.040 ~ +0.124	0 ~ +0.021	0 ~ -0.052
>30 ~ 50	+0.050 ~ +0.150	0 ~ +0.025	0 ~ -0.062
>50 ~ 80	+0.060 ~ +0.180	0 ~ +0.030	0 ~ -0.074
>80 ~ 120	+0.072 ~ +0.212	0 ~ +0.035	0 ~ -0.087
>120 ~ 180	+0.085 ~ +0.245	0 ~ +0.040	0 ~ -0.100



● 标准产品规格表 Standard specifications: P128

产品特性 Product features

- 中等载荷的优化材料。适用于运动频率较低和低成本需求
- 连续使用温度: -40°C/+100°C
- 承受较高的载荷
- 经济性强
- 干运行、免维护
- 适用于不同轴材料
- Optimized for middle load applications. It is suitable for low frequency motion and low cost requirement
- Continuous working temperature: -40°C/+100°C
- High load capacity
- Good economic ratio
- Dry operation and maintenance free
- Applicable for various shaft materials

材料数据表 Material properties data table

材料性能 Material properties	测试标准 Standard	单位 Unit	CSB-EPB3G
颜色 Color	-	-	黑色 Black
密度 Density	ISO1183	g/cm ³	1.37
最大吸湿率 Max. moisture absorption, 50%RH	ISO62	%	1.3
最大吸水率 Max. water absorption	ISO62	%	5.5
对钢动摩擦系数 Coefficient of sliding friction(steel)	ITS025	μ	0.05-0.15
极限PV值 Max. PV value	ITS026	N/mm ² × m/s	0.30
弯曲模量 Flexural modulus	ISO178	MPa	7700
弯曲强度 Flexural strength	ISO178	MPa	190
最大静载荷 Max. static load	ITS027	MPa	75
最大动载荷 Max. dynamic load	ITS028	MPa	36
邵氏硬度 Shore hardness	ISO868	D	78
连续运行温度 Long-term application temperature	ITS029	°C	+100
短时运行温度 Short-term application temperature	ITS029	°C	+160
最低运行温度 Lowest application temperature	ITS029	°C	-40
导热性 Thermal conductivity	ISO22007	W/m/K	0.24
线性热膨胀系数 Coefficient of thermal expansion	ISO11359	K ⁻¹ × 10 ⁻⁵	11
阻燃等级 Flammability	UL94	Class	HB
体电阻率 Volume resistance	IEC60093	Ω·cm	>10 ¹²
面电阻率 Surface resistance	IEC60093	Ω	>10 ¹¹

*ITS: CSB内部测试标准 CSB company's internal test standards.

**除非特殊说明测试温度为23°C Test temperatures are 23°C unless otherwise stated.

轴承PV值 PV value

CSB-EPB3G塑料轴承最大运行PV值为0.3N/mm² × m/s; 由此决定轴承所承受的载荷与速度成反比, 详细查阅图表EPB3G-1。

The max PV value of the CSB-EPB3G plastic bearings is 0.3N/mm² × m/s which determines the load capacity of bearing is inversely proportional to the speed. Please refer to the chart for more detailed information (Graph EPB3G-1).

■ PV图表 Permissible PV value for CSB-EPB3G

图表 Graph EPB3G-1

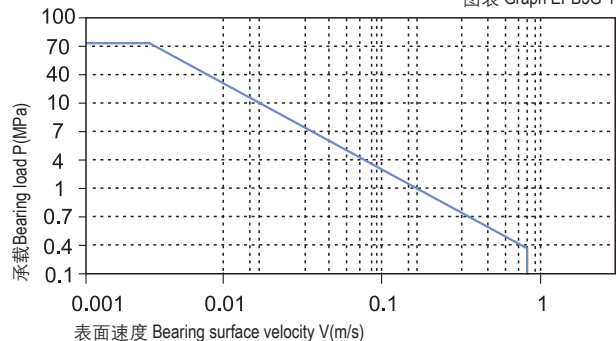

轴承的载荷、速度、温度 Load, speed and temperature

CSB-EPB3G塑料轴承可承受最大静载荷为75Mpa, 在此载荷下轴承的最大压缩变形量参考图表EPB3G-2, 轴承实际工作载荷略小于75Mpa, 载荷还受到运行速度以及温度的影响, 速度越快 (Vmax: 0.8m/s) 会导致摩擦温度上升, 而温度上升 (Tmax: 100℃) 会导致轴承的承载能力逐渐减弱, 载荷随轴承工作温度变化情况参考图表EPB3G-3。

CSB-EPB3G allows the Max static load of 75Mpa, The max compressive deformation rate under the max load is listed in Graph EPB3G-2, The actual load capacity of bearing is slightly less than 75Mpa, The bearing load is variable against the speed and temperature, Fast speed (Vmax: 0.8m/s) results into higher temperature (Tmax: 100℃) which decreases the load capacity of the bearing. Please refer to the Graph EPB3G-3 for such variation.

轴承的摩擦系数、磨损、轴材料 Friction factor, wear and shaft material

摩擦系数 Friction factor

图表EPB3G-4与图表EPB3G-5表明CSB-EPB3G塑料轴承的摩擦系数会受到运行速度以及轴承载荷影响而发生变化, 当轴承载荷在20Mpa以内时, 这种表现特别明显。同时图表EPB3G-6显示CSB-EPB3G塑料轴承的摩擦系数还会受到对磨轴表面粗糙度的影响, 轴表面太光滑或者太粗糙都会导致轴承的摩擦系数和磨损值增大, 我们推荐轴表面粗糙度为Ra0.1 ~ 0.3mm最为合适。

Graph EPB3G-4 and Graph EPB3G-5 show that the friction factor of CSB-EPB3G is variable along with the changing of the operation speed and bearing loading especially when the bearing loading is within 20Mpa. In the mean while the Graph EPB3G-6 shows that the friction factor of CSB-EPB3G is also affected by the shaft surface roughness. Too rough shaft surface or too fine shaft surface will increase the wearing and friction factor. The recommended shaft surface roughness is Ra0.1-0.3.

摩擦系数与轴表面粗糙度关系图表

Coefficient of friction & the surface roughness of shaft

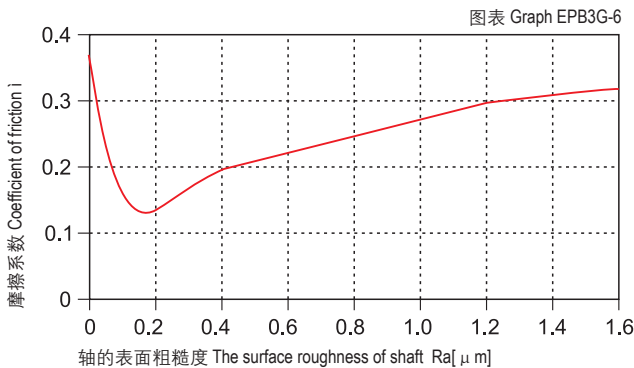

载荷-温度-变形量图表 Load-Temperature deformation

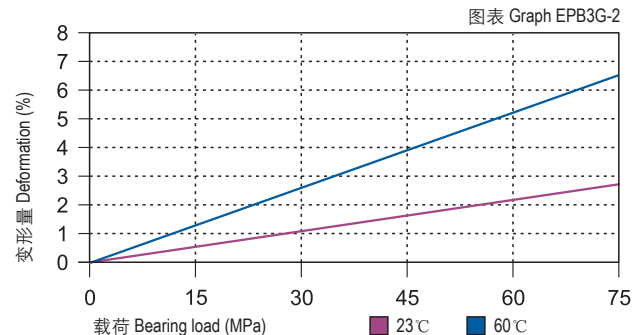

载荷-温度图表 Load-Temperature diagrams

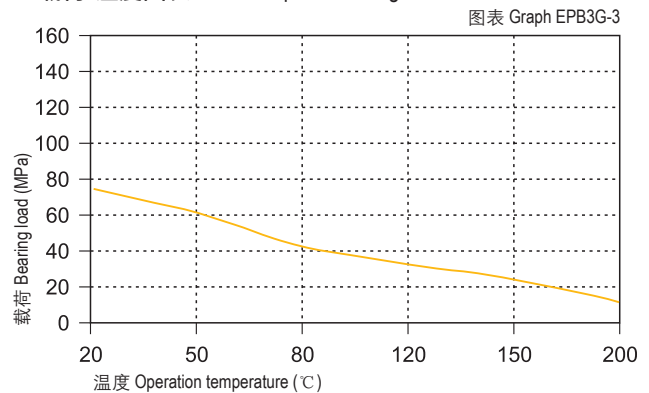

摩擦系数与速度变化关系图表 P=2MPa

Coefficient of friction & the speed of bearing, p = 2 MPa

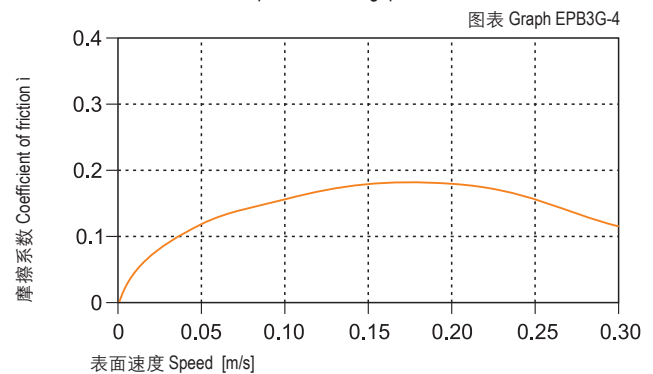

摩擦系数与载荷变化关系图表 v=0.2m/s

Coefficient of friction & the pressure of bearing, v = 0.2 m/s

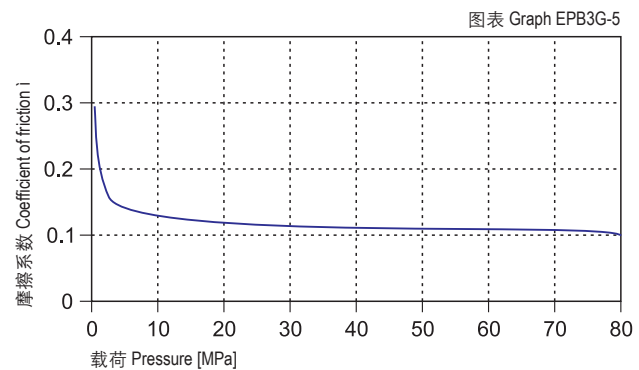

CSB-EPB3G	干运行 Dry	油脂 Grease	油 Oil	水 Water
摩擦系数 μ Friction coef.	0.05~0.15	0.09	0.04	0.04

磨损与轴材料 Wearing and shaft material

图表EPB3G-7与图表EPB3G-8表明CSB-EPB3G塑料轴承无论是在普通轴上运行还是在硬质轴上运行磨损值基本相当，根据图表显示CSB-EPB3G塑料轴承最适合的轴材料为硬化轴和硬铬钢轴；根据图表EPB3G-7显示CSB-EPB3G塑料轴承在摆动运动下的磨损值会略优越于旋转运动下的磨损值。

Graph EPB3G-7 and Graph EPB3G-8 show that the wearing of CSB-EPB3G is similar either against the normal shaft or hardened shaft. The most suitable shaft materials for CSB-EPB3G are hardened steel and hardened chrome steel. Graph EPB3G-7 shows that the wearing feature is better in oscillation operation than in rotation operation.

化学抗性 Chemical resistance

CSB-EPB3G塑料轴承能抵抗弱碱以及各类润滑油的腐蚀。

CSB-EPB3G is good at chemical resistance against weak acidic medium and various kinds of lubricants.

吸水性 Water absorption

CSB-EPB3G塑料轴承在标准大气中的吸湿率为1.3%。浸泡在水中最高吸水率为5.5%。由于高吸水率的特性，我们必须考虑此轴承的应用环境。

The moisture absorption of CSB-EPB3G plastic plain bearings is 1.3% in standard atmosphere. The max. water absorption is 5.5% in water. The application environment has to be considered due to the high water absorption properties.

抗UV性能 UV resistance

CSB-EPB3G塑料轴承长久暴露在紫外线下颜色基本不会改变。材料性能基本都不会发生改变。

CSB-EPB3G can maintain its color unchanged when it is exposed into the UV ray. The material performance stays stable.

安装公差 Installation tolerances

CSB-EPB3G塑料轴承压装后公差 Tolerances after pressfit

直径 Di. [mm]	CSB-EPB3G E10 [mm]	座孔 Housing H7 [mm]	轴 Shaft h9 [mm]
>0 ~ 3	+0.014 ~ +0.054	0 ~ +0.010	0 ~ -0.025
>3 ~ 6	+0.020 ~ +0.068	0 ~ +0.012	0 ~ -0.030
>6 ~ 10	+0.025 ~ +0.083	0 ~ +0.015	0 ~ -0.036
>10 ~ 18	+0.032 ~ +0.102	0 ~ +0.018	0 ~ -0.043
>18 ~ 30	+0.040 ~ +0.124	0 ~ +0.021	0 ~ -0.052
>30 ~ 50	+0.050 ~ +0.150	0 ~ +0.025	0 ~ -0.062
>50 ~ 80	+0.060 ~ +0.180	0 ~ +0.030	0 ~ -0.074
>80 ~ 120	+0.072 ~ +0.212	0 ~ +0.035	0 ~ -0.087
>120 ~ 180	+0.085 ~ +0.245	0 ~ +0.040	0 ~ -0.100

在不同轴材料上旋转时的磨损量 $p=2\text{MPa}$, $v=0.2\text{m/s}$ Wear under rotating with different shaft materials, $p = 2 \text{ MPa}$, $v = 0.2 \text{ m/s}$

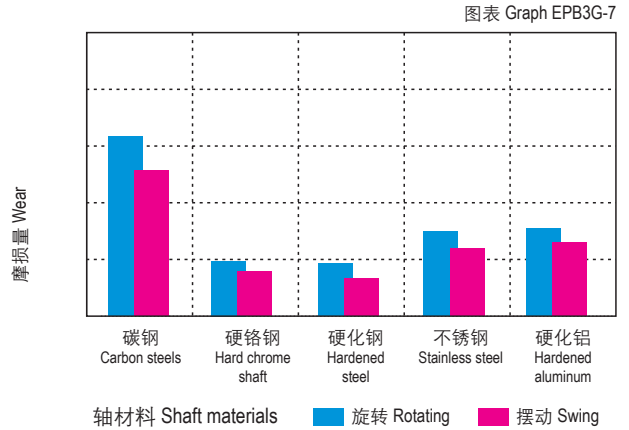

旋转磨损随轴材料与压力变化关系 $v=0.2\text{m/s}$ Wear & pressure under rotating with different shaft materials, $v = 0.2 \text{ m/s}$

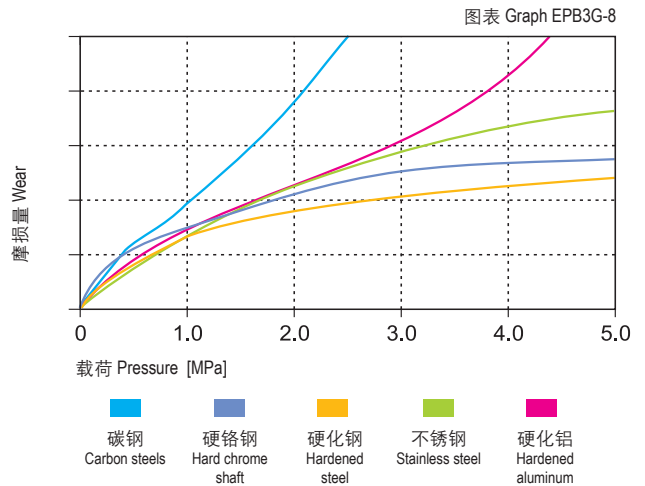

吸水性的影响

Effect of moisture absorption on EPB3G bearings

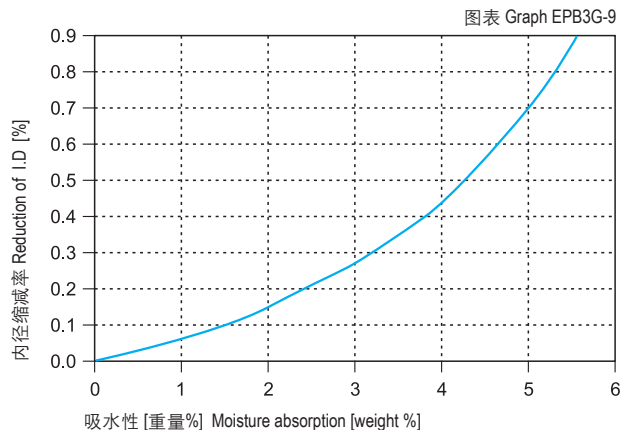



产品特性 Product features

- 抗冲击性能出色的自润滑材料。作为一种耐冲击的材料被用于需要吸震和耐磨的场合
- 连续使用温度: -40°C/+80°C
- 承受较高的载荷, 耐冲压
- 经济性强
- 干运行、免维护
- 承受边缘载荷
- 适合低速运动
- An excellent self-lubricated material suitable for impact resistance applications which is widely used under the environment of impact absorbing and wear resistance requirement
- Continuous working temperature: -40°C/+80°C
- High load capacity, Impact resistance
- Low cost
- Dry operation and maintenance free
- Good for Marginal Load
- Suitable for low speed operation

● 标准产品规格表 Standard specifications: P138

材料数据表 Material properties data table

材料性能 Material properties	测试标准 Standard	单位 Unit	CSB-EPB3M
颜色 Color	-	-	深灰 Dark grey
密度 Density	ISO1183	g/cm ³	1.14
最大吸湿率 Max. moisture absorption, 50%RH	ISO62	%	1.4
最大吸水率 Max. water absorption	ISO62	%	7.6
对钢动摩擦系数 Coefficient of sliding friction(steel)	ITS025	μ	0.09-0.30
极限PV值 Max. PV value	ITS026	N/mm ² × m/s	0.15
弯曲模量 Flexural modulus	ISO178	MPa	2700
弯曲强度 Flexural strength	ISO178	MPa	100
最大静载荷 Max. static load	ITS027	MPa	30
最大动载荷 Max. dynamic load	ITS028	MPa	15
邵氏硬度 Shore hardness	ISO868	D	79
连续运行温度 Long-term application temperature	ITS029	°C	+80
短时运行温度 Short-term application temperature	ITS029	°C	+170
最低运行温度 Lowest application temperature	ITS029	°C	-40
导热性 Thermal conductivity	ISO22007	W/m/K	0.24
线性热膨胀系数 Coefficient of thermal expansion	ISO11359	K ⁻¹ × 10 ⁻⁵	10
阻燃等级 Flammability	UL94	Class	HB
体电阻率 Volume resistance	IEC60093	Ω · cm	>10 ¹²
面电阻率 Surface resistance	IEC60093	Ω	>10 ¹¹

*ITS: CSB内部测试标准 CSB company's internal test standards.

**除非特殊说明测试温度为23°C Test temperatures are 23°C unless otherwise stated.

轴承PV值 PV value

CSB-EPB3M塑料轴承最大运行PV值为0.15N/mm² × m/s; 由此决定轴承所承受的载荷与速度成反比, 详细查阅图表EPB3M-1。

The max PV value of the CSB-EPB3M plastic bearings is 0.15N/mm² × m/s which determines the load capacity of bearing is inversely proportional to the speed. Please refer to the chart for more detailed information (Graph EPB3M-1).

■ PV图表 Permissible PV value for CSB-EPB3M

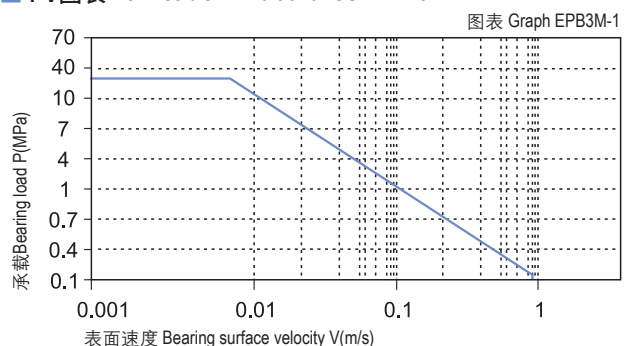

轴承的载荷、速度、温度 Load, speed and temperature

CSB-EPB3M塑料轴承可承受最大静载荷为30Mpa，在此载荷下轴承的最大压缩变形量参考图表EPB3M-2，轴承实际工作载荷略小于30Mpa，载荷还受到运行速度以及温度的影响，速度越快 (Vmax: 0.8m/s) 会导致摩擦温度上升，而温度上升 (Tmax: 80℃) 会导致轴承的承载能力逐渐减弱，载荷随轴承工作温度变化情况参考图表EPB3M-3。

CSB-EPB3M allows the Max static load of 30Mpa, The max compressive deformation rate under the max load is listed in Graph EPB3M-2, The actual load capacity of bearing is slightly less than 30Mpa, The bearing load is variable against the speed and temperature, Fast speed (Vmax: 0.8m/s) results into higher temperature (Tmax: 80℃) which decreases the load capacity of the bearing. Please refer to the Graph EPB3M-3 for such variation.

轴承的摩擦系数、磨损、轴材料 Friction factor, wear and shaft material

摩擦系数 Friction factor

图表EPB3M-4表明CSB-EPB3M塑料轴承的摩擦系数在载荷一定的情况下随着速度的增加而快速升高，这就说明此轴承比较适合用于低速场合；图表EPB3M-5表明CSB-EPB3M塑料轴承在速度一定的情况下摩擦系数随着载荷的增加而逐渐降低。滑动轴承的摩擦系数和磨损受对磨轴表面粗糙度影响比较大，图表EPB3M-6表明CSB-EPB3M塑料轴承在表面粗糙度为Ra=0.6um轴上运行时可以获得更佳运行效果。

CSB-EPB3M Bearing Friction factor is increased along with the increasing of the operation speed (See Graph EPB3M-4) therefore it is suitable for the application under low speed operation. The friction factor of CSB-EP3M is decreased along with the loading increasing (see Graph EPB3M-5). The friction factor and wearing of the bearing is considerably affected by the counter shaft roughness. The Graph EPB3M-6 shows that the bearing could achieve its best performance when the counter shaft surface roughness is around Ra0.6.

摩擦系数与轴表面粗糙度关系图表 Coefficient of friction & the surface roughness of shaft

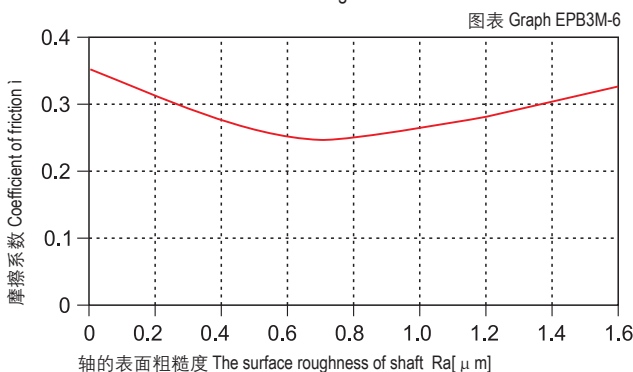

载荷-温度-变形量图表 Load-Temperature deformation

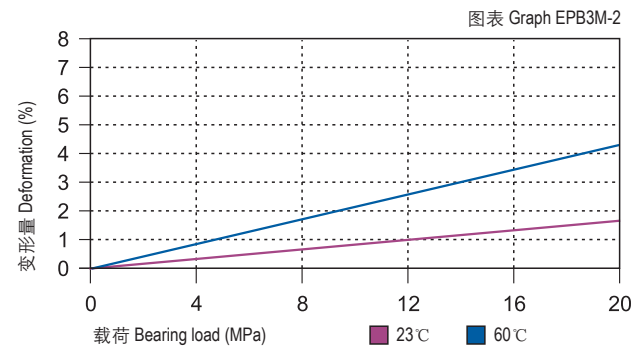

载荷-温度图表 Load-Temperature diagrams

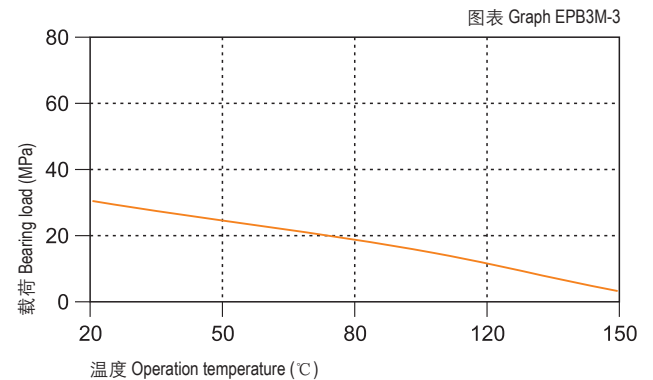

摩擦系数与速度变化关系图表 P=2MPa Coefficient of friction & the speed of bearing, p = 2 MPa

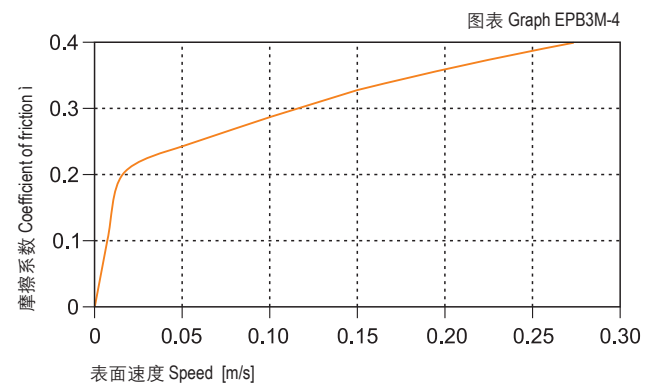

摩擦系数与载荷变化关系图表 v=0.2m/s Coefficient of friction & the pressure of bearing, v = 0.2 m/s

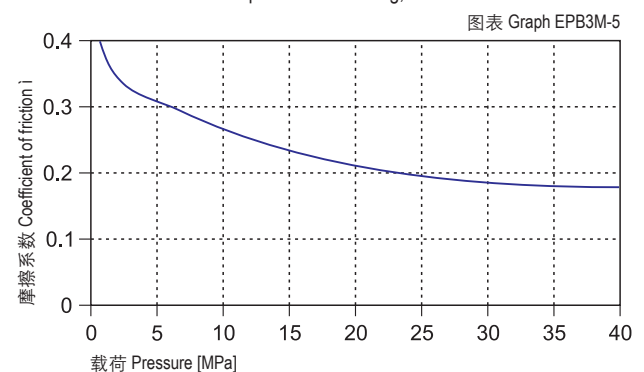

CSB-EPB3M	干运行 Dry	油脂 Grease	油 Oil	水 Water
摩擦系数 μ Friction coef.	0.09~0.30	0.09	0.04	0.04

磨损与轴材料 Wearing and shaft material

图表EPB3M-7表明CSB-EPB3M塑料轴承在不同轴材料上的运行效果表明此轴承在载荷超过2Mpa且做旋转运动时与轴材料的关系相对较小，由此图可以看出在低载荷时CSB-EPB3M塑料轴承运行效果较好。当轴承的载荷增加时，轴承的磨损会快速上升；由图表EPB3M-8可以看出在高载荷时CSB-EPB3M塑料轴承比较适合用于硬铬轴上运行。图表EPB3M-7表明CSB-EPB3M塑料轴承在用于旋转运动时的性能要明显优越于摆动运动。

Test of the bearing against various shaft materials shows that the material CSB-EPB3M features the wearing performance of the material is not sensitive with different materials where the loading is over 2Mpa. (See Graph EPB3M-7). The bearing performance remains the best when the loading is in the lower range. When the loading is increased, the wearing will be sharply increased. From the Graph EPB3M-8, the CSB-EPB3M material is better for the application with the counter shaft material of hard chrome steel. Graph EPB3M-7 shows that the material is better for rotation operation than oscillation operation.

化学抗性 Chemical resistance

CSB-EPB3M塑料轴承能抵抗弱碱以及各类润滑油的腐蚀。CSB-EPB3M is good at chemical resistance against weak acidic medium and various kinds of lubricants.

吸水性 Water absorption

CSB-EPB3M塑料轴承在标准大气中的吸湿率为1.4%。浸泡在水中最高吸水率为7.6%。由于高吸水率的特性，我们必须考虑此轴承的应用环境。

The moisture absorption of CSB-EPB3M plastic plain bearings is 1.4% in standard atmosphere. The max. water absorption is 7.6% in water. The application environment has to be considered due to the high water absorption properties.

抗UV性能 UV resistance

CSB-EPB3M塑料轴承长久暴露在紫外线下颜色基本不会改变。材料性能基本都不会发生改变。

CSB-EPB3M can maintain its color unchanged when it is exposed into the UV ray. The material performance stays stable.

安装公差 Installation tolerances

CSB-EPB3M塑料轴承压装后公差 Tolerances after pressfit

直径 Di. [mm]	CSB-EPB3M D11 [mm]	座孔 Housing H7 [mm]	轴 Shaft h9 [mm]
>0 ~ 3	+0.020 ~ +0.080	0 ~ +0.010	0 ~ -0.025
>3 ~ 6	+0.030 ~ +0.105	0 ~ +0.012	0 ~ -0.030
>6 ~ 10	+0.040 ~ +0.130	0 ~ +0.015	0 ~ -0.036
>10 ~ 18	+0.050 ~ +0.160	0 ~ +0.018	0 ~ -0.043
>18 ~ 30	+0.065 ~ +0.195	0 ~ +0.021	0 ~ -0.052

在不同轴材料上旋转时的磨损量 $p=2\text{MPa}$, $v=0.2\text{m/s}$

Wear under rotating with different shaft materials, $p = 2 \text{ MPa}$, $v = 0.2 \text{ m/s}$

图表 Graph EPB3M-7

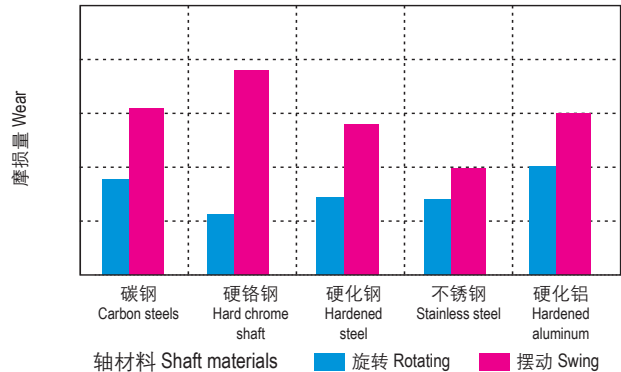

旋转磨损随轴材料与压力变化关系 $v=0.2\text{m/s}$

Wear & pressure under rotating with different shaft materials, $v = 0.2 \text{ m/s}$

图表 Graph EPB3M-8

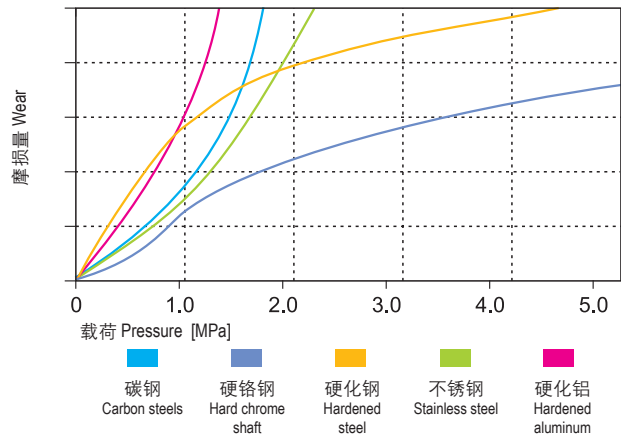

吸水性的影响 Effect of moisture absorption on EPB3M bearings

图表 Graph EPB3M-9

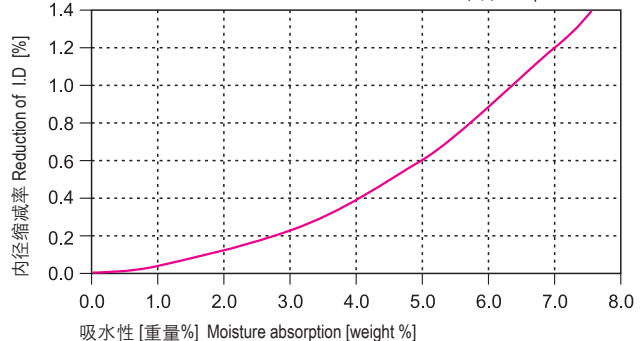

直径 Di. [mm]	CSB-EPB3M D11 [mm]	座孔 Housing H7 [mm]	轴 Shaft h9 [mm]
>30 ~ 50	+0.080 ~ +0.240	0 ~ +0.025	0 ~ -0.062
>50 ~ 80	+0.100 ~ +0.290	0 ~ +0.030	0 ~ -0.074
>80 ~ 120	+0.120 ~ +0.340	0 ~ +0.035	0 ~ -0.087
>120 ~ 180	+0.145 ~ +0.395	0 ~ +0.040	0 ~ -0.100



产品特性 Product features

- 高温和良好的化学抗性材料。可在200度下连续使用，也适用于潮湿环境甚至化学液体中。硬质轴材料与之配合使用较好
- 连续使用温度：-40℃/+200℃
- 适合多数中高载荷场合
- 适合干运行、免维护
- 良好的化学抗性
- 适合潮湿环境中使用
- High temperature material with good chemical resistance feature. It could be continuously used under the temperature of 200 °C, it is also suitable to be used in the humid environment and even inside the chemical liquids. It is best to be used against hard materials
- Continuous working temperature: -40 °C/+200 °C
- Suitable for medium and high load operation
- Maintenance-free dry operation
- Good chemical resistance
- Suitable for humid environment

● 标准产品规格表 Standard specifications: P132

材料数据表 Material properties data table

材料性能 Material properties	测试标准 Standard	单位 Unit	CSB-EPB4
颜色 Color	-	-	黑色 Black
密度 Density	ISO1183	g/cm ³	1.70
最大吸湿率 Max. moisture absorption, 50%RH	ISO62	%	0.1
最大吸水率 Max. water absorption	ISO62	%	0.3
对钢动摩擦系数 Coefficient of sliding friction(steel)	ITS025	μ	0.07-0.20
极限PV值 Max. PV value	ITS026	N/mm ² × m/s	1.35
弯曲模量 Flexural modulus	ISO178	MPa	12000
弯曲强度 Flexural strength	ISO178	MPa	165
最大静载荷 Max. static load	ITS027	MPa	90
最大动载荷 Max. dynamic load	ITS028	MPa	50
邵氏硬度 Shore hardness	ISO868	D	82
连续运行温度 Long-term application temperature	ITS029	°C	+200
短时运行温度 Short-term application temperature	ITS029	°C	+240
最低运行温度 Lowest application temperature	ITS029	°C	-40
导热性 Thermal conductivity	ISO22007	W/m/K	0.60
线性热膨胀系数 Coefficient of thermal expansion	ISO11359	K ⁻¹ × 10 ⁻⁵	4
阻燃等级 Flammability	UL94	Class	V0
体电阻率 Volume resistance	IEC60093	Ω · cm	>10 ⁵
面电阻率 Surface resistance	IEC60093	Ω	>10 ⁵

*ITS: CSB内部测试标准 CSB company's internal test standards.

**除非特殊说明测试温度为23℃ Test temperatures are 23 °C unless otherwise stated.

轴承PV值 PV value

CSB-EPB4塑料轴承最大运行PV值1.35N/mm² × m/s; 由此决定轴承所承受的载荷与速度成反比，详细查阅图表EPB4-1。

The max PV value of the CSB-EPB4 plastic bearings is 1.35N/mm² × m/s which determines the load capacity of bearing is inversely proportional to the speed. Please refer to the chart for more detailed information (Graph EPB4-1).

■ PV图表 Permissible PV value for CSB-EPB4

图表 Graph EPB4-1

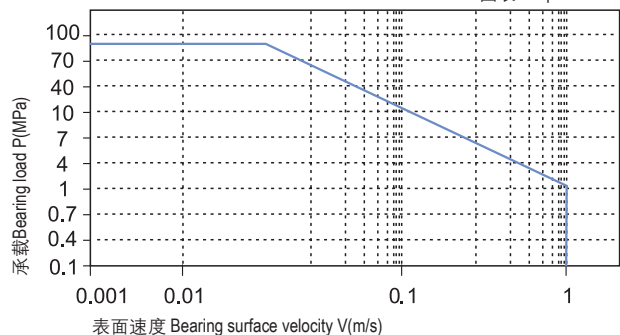

轴承的载荷、速度、温度 Load, speed and temperature

CSB-EPB4塑料轴承可承受最大静载荷为90Mpa，在此载荷下轴承的最大压缩变形量参考图表EPB4-2，轴承实际工作载荷略小于90Mpa，载荷还受到运行速度以及温度的影响，速度越快 (Vmax: 1.0m/s) 会导致摩擦温度上升，而温度上升 (Tmax: 200℃) 会导致轴承的承载能力逐渐减弱，载荷随轴承工作温度变化情况参考图表EPB4-3。

CSB-EPB4 allows the Max static load of 90Mpa, The max compressive deformation rate under the max load is listed in Graph EPB4-2, The actual load capacity of bearing is slightly less than 90Mpa, The bearing load is variable against the speed and temperature, Fast speed (Vmax: 1.0m/s) results into higher temperature (Tmax: 200℃) which decreases the load capacity of the bearing. Please refer to the Graph EPB4-3 for such variation.

轴承的摩擦系数、磨损、轴材料 Friction factor, wear and shaft material

摩擦系数 Friction factor

图表EPB4-4表明CSB-EPB4塑料轴承在载荷保持不变时旋转下的摩擦系数会随着速度的增加而略有减低；图表EPB4-5表明CSB-EPB4塑料轴承在速度保持不变时旋转下的摩擦系数会随着载荷的增加而逐步降低，特别是在载荷小于30Mpa的情况下。图表EPB4-6表明CSB-EPB4塑料轴承的对磨轴粗糙度在Ra0.1~0.4um时摩擦系数几乎没有变化，但当轴表面粗糙度大于Ra0.4时摩擦系数会快速上升；我们推荐使用轴的粗糙度为Ra0.1~0.4um。

Friction factor will be slightly decreased along with the speed increasing under certain loading of the rotation operation (see Graph EPB4-4) and it will be slightly decreased along with the loading increasing under certain speed of the rotation operation especially when the loading is less than 30Mpa. Graph EPB4-5 tells that the friction of the CSB-EPB4 is not changed at all when the shaft roughness is between Ra0.1 to Ra0.4 and will be considerably increased when the shaft roughness is over Ra0.4. So the recommended shaft roughness is Ra0.1-Ra0.4.

摩擦系数与轴表面粗糙度关系图表

Coefficient of friction & the surface roughness of shaft

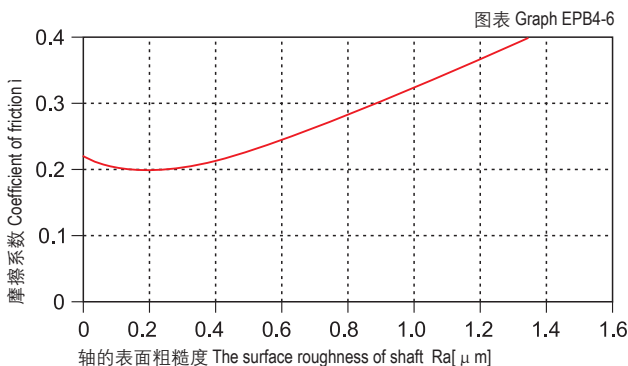

载荷-温度-变形量图表 Load-Temperature deformation

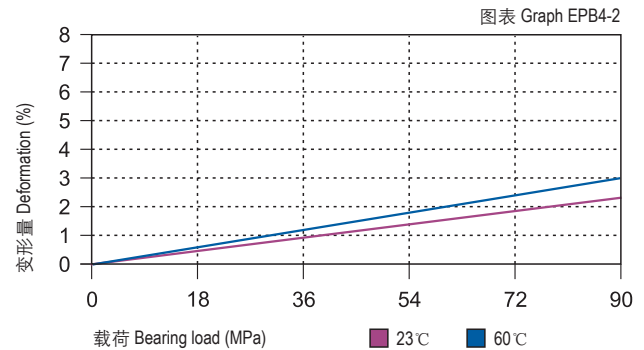

载荷-温度图表 Load-Temperature diagrams

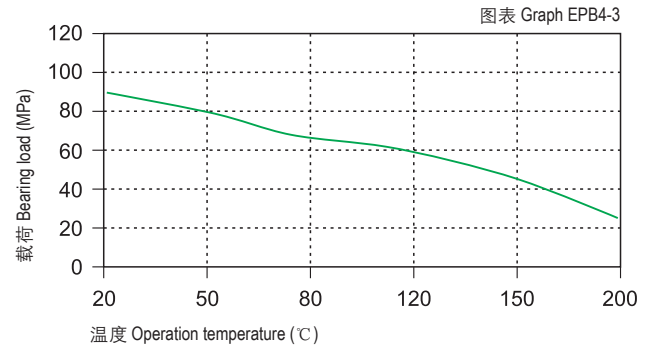

摩擦系数与速度变化关系图表 P=2MPa

Coefficient of friction & the speed of bearing, p = 2 MPa

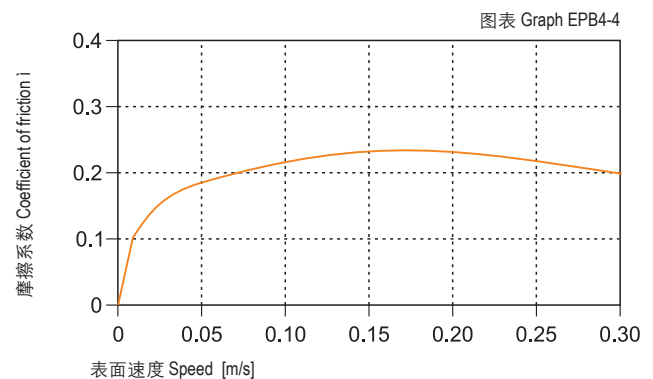

摩擦系数与载荷变化关系图表 v=0.2m/s

Coefficient of friction & the pressure of bearing, v = 0.2 m/s

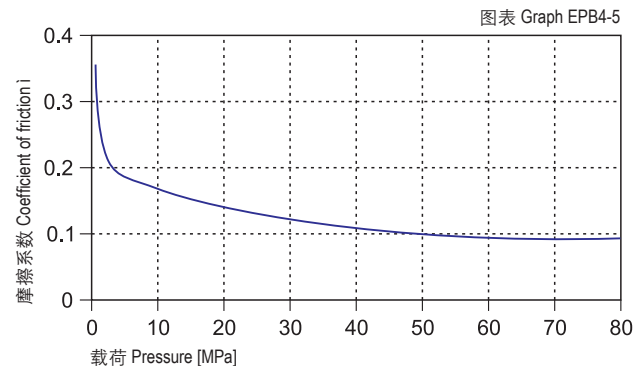

CSB-EPB4	干运行 Dry	油脂 Grease	油 Oil	水 Water
摩擦系数 μ Friction coef.	0.07-0.20	0.09	0.04	0.04

磨损与轴材料 Wearing and shaft material

图表EPB4-7表明CSB-EPB4塑料轴承在低载荷旋转运动时适合大都数轴材料，而在高载旋转下硬化钢轴表现尤为特出（见图表EPB4-8）；CSB-EPB4塑料轴承在采用不锈钢轴摆动运动下较为合适，而在旋转运动中碳钢轴和硬化钢轴效果比较好。

Graph EPB4-7 shows that CSB-EPB4 is suitable for most of the shaft materials under low loading rotation operation and it is good for hardened carbon steel shaft under high loading rotation operation (see Graph EPB4-8). CSB-EPB4 is suitable for stainless steel shaft under oscillation operation and good for hot rolled carbon steel and hardened carbon steel shaft under rotation operation.

化学抗性 Chemical resistance

CSB-EPB4塑料轴承具有很好的化学抗性，能抵抗绝大多数酸碱。

The Chemical Resistance of CSB-EPB4 is fairly good against most of Acid and Alkalis.

吸水性 Water absorption

CSB-EPB4塑料轴承在标准大气中的吸湿率为0.1%。浸泡在水中的最高吸水率为0.3%。极低吸水率不会导致轴承发生性能变化和尺寸变化，非常适合用于潮湿环境。

The moisture absorption of CSB-EPB4 plastic plain bearings is 0.1% in standard atmosphere. The max. water absorption is 0.3% in water. These values are very low, CSB-EPB4 plastic plain bearings is very well suited for used in wet applications.

抗UV性能 UV resistance

CSB-EPB4塑料轴承长久暴露在紫外线下材料表面会发生蜕变，抗压强度会下降。

Disintegration could be possible for the material CSB-EPB4 after long period of exposing under the UV ray and therefore the compressive strength will be reduced.

安装公差 Installation tolerances

CSB-EPB4塑料轴承压装后公差 Tolerances after pressfit

直径 Di. [mm]	CSB-EPB4 F10 [mm]	座孔 Housing H7 [mm]	轴 Shaft h9 [mm]
>0 ~ 3	+0.006 ~ +0.046	0 ~ +0.010	0 ~ -0.025
>3 ~ 6	+0.010 ~ +0.058	0 ~ +0.012	0 ~ -0.030
>6 ~ 10	+0.013 ~ +0.071	0 ~ +0.015	0 ~ -0.036
>10 ~ 18	+0.016 ~ +0.086	0 ~ +0.018	0 ~ -0.043
>18 ~ 30	+0.020 ~ +0.104	0 ~ +0.021	0 ~ -0.052

在不同轴材料上旋转时的磨损量 $p=2\text{MPa}$, $v=0.2\text{m/s}$

Wear under rotating with different shaft materials, $p = 2 \text{ MPa}$, $v = 0.2 \text{ m/s}$

图表 Graph EPB4-7

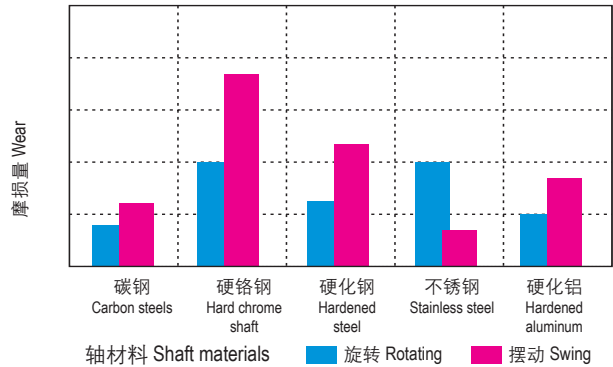

旋转磨损随轴材料与压力变化关系 $v=0.2\text{m/s}$

Wear & pressure under rotating with different shaft materials, $v = 0.2 \text{ m/s}$

图表 Graph EPB4-8

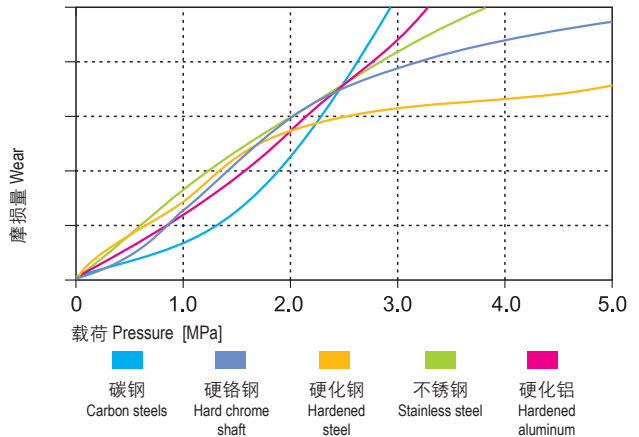

吸水性的影响 Effect of moisture absorption on EPB4 bearings

图表 Graph EPB4-9

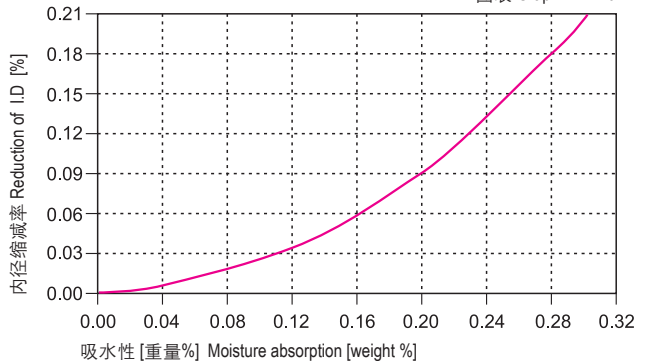

直径 Di. [mm]	CSB-EPB4 F10 [mm]	座孔 Housing H7 [mm]	轴 Shaft h9 [mm]
>30 ~ 50	+0.025 ~ +0.125	0 ~ +0.025	0 ~ -0.062
>50 ~ 80	+0.030 ~ +0.150	0 ~ +0.030	0 ~ -0.074
>80 ~ 120	+0.036 ~ +0.176	0 ~ +0.035	0 ~ -0.087
>120 ~ 180	+0.043 ~ +0.203	0 ~ +0.040	0 ~ -0.100



● 标准产品规格表 Standard specifications: P135

产品特性 Product features

- 高温250度自润滑材料。高化学抗性可被用于多数腐蚀性液体中。高承载能力，一般用于高温或高化学腐蚀场合
- 连续使用温度: -100℃/+250℃
- 适合高载荷运用
- 高温下保持较高的承载能力
- 较广泛的化学抗性
- 非常低的吸水率
- 较高的抗压强度
- Self-lubricated material for high temperature up to 250 °C. With its high chemical resistance feature, it could be used inside most common chemical liquids. It is a high load material for the applications of high temperature and critical chemical environments
- Continuous working temperature: -100 °C/+250 °C
- Suitable for high load operation
- High load capacity at higher temperature
- Good chemical resistance
- Low water absorption
- High pressure resistance

材料数据表 Material properties data table

材料性能 Material properties	测试标准 Standard	单位 Unit	CSB-EPB5
颜色 Color	-	-	黑色 Black
密度 Density	ISO1183	g/cm ³	1.44
最大吸湿率 Max. moisture absorption, 50%RH	ISO62	%	0.1
最大吸水率 Max. water absorption	ISO62	%	0.5
对钢动摩擦系数 Coefficient of sliding friction(steel)	ITS025	μ	0.09-0.25
极限PV值 Max. PV value	ITS026	N/mm ² × m/s	1.40
弯曲模量 Flexural modulus	ISO178	MPa	4800
弯曲强度 Flexural strength	ISO178	MPa	165
最大静载荷 Max. static load	ITS027	MPa	110
最大动载荷 Max. dynamic load	ITS028	MPa	61
邵氏硬度 Shore hardness	ISO868	D	82
连续运行温度 Long-term application temperature	ITS029	°C	+250
短时运行温度 Short-term application temperature	ITS029	°C	+315
最低运行温度 Lowest application temperature	ITS029	°C	-100
导热性 Thermal conductivity	ISO22007	W/m/K	0.55
线性热膨胀系数 Coefficient of thermal expansion	ISO11359	K ⁻¹ × 10 ⁻⁵	6
阻燃等级 Flammability	UL94	Class	V0
体电阻率 Volume resistance	IEC60093	Ω · cm	>10 ⁸
面电阻率 Surface resistance	IEC60093	Ω	>10 ⁷

*ITS: CSB内部测试标准 CSB company's internal test standards.

**除非特殊说明测试温度为23℃ Test temperatures are 23℃ unless otherwise stated.

轴承PV值 PV value

CSB-EPB5塑料轴承最大运行PV值为1.4N/mm² × m/s; 由此决定轴承所承受的载荷与速度成反比, 详细查阅图表EPB5-1。

The max PV value of the CSB-EPB5 plastic bearings is 1.4N/mm² × m/s which determines the load capacity of bearing is inversely proportional to the speed. Please refer to the chart for more detailed information (Graph EPB5-1).

■ PV图表 Permissible PV value for CSB-EPB5

图表 Graph EPB5-1

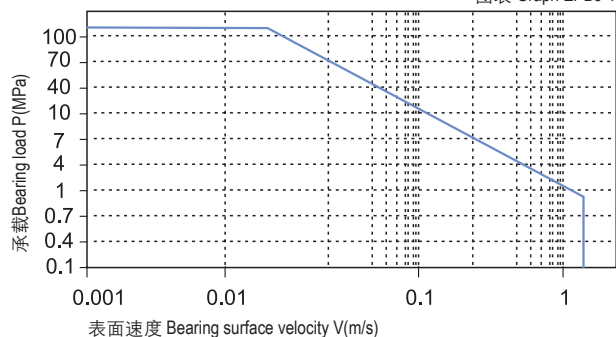

轴承的载荷、速度、温度 Load, speed and temperature

CSB-EPB5塑料轴承可承受最大静载荷为110Mpa，在此载荷下轴承的最大压缩变形量参考图表EPB5-2，轴承实际工作载荷略小于110Mpa，载荷还受到运行速度以及温度的影响，速度越快 (Vmax: 1.5m/s) 会导致摩擦温度上升，而温度上升 (Tmax: 250℃) 会导致轴承的承载能力逐渐减弱，载荷随轴承工作温度变化情况参考图表EPB5-3。

CSB-EPB5 allows the Max static load of 110Mpa, The max compressive deformation rate under the max load is listed in Graph EPB5-2, The actual load capacity of bearing is slightly less than 110Mpa, The bearing load is variable against the speed and temperature, Fast speed (Vmax: 1.5m/s) results into higher temperature (Tmax: 250℃) which decreases the load capacity of the bearing. Please refer to the Graph EPB5-3 for such variation.

轴承的摩擦系数、磨损、轴材料 Friction factor, wear and shaft material

摩擦系数 Friction factor

图表EPB5-4表明CSB-EPB5塑料轴承的摩擦系数在载荷一定时随着运行速度的增加而逐渐升高；图表EPB5-5表明CSB-EPB5塑料轴承在速度一定载荷在20Mpa以内时摩擦系数会随着载荷的逐步增加而快速降低，而当载荷高于20Mpa时摩擦系数的变化却比较平缓。图表EPB5-6表明CSB-EPB5塑料轴承比较适合的表面粗糙度为Ra0.6 ~ 0.8 μ m。

CSB-EPB5 Bearing Friction factor is increased along with the increasing of the operation speed under certain loading (See Graph EPB5-4). The friction factor of CSB-EP5 is decreased along with the loading increasing not over 20Mpa (see Graph EPB5-5). The friction factor will not change much along with the speed when the loading is over 20Mpa. The Graph EPB5-6 shows that the bearing could achieve its best performance when the counter shaft surface roughness is around Ra0.6 to Ra0.8.

摩擦系数与轴表面粗糙度关系图表

Coefficient of friction & the surface roughness of shaft

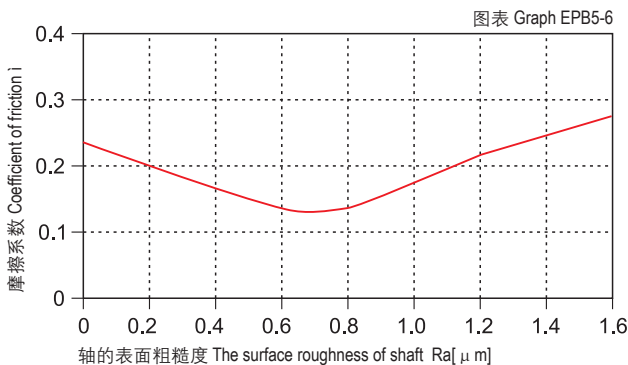

载荷-温度-变形量图表 Load-Temperature deformation

图表 Graph EPB5-2

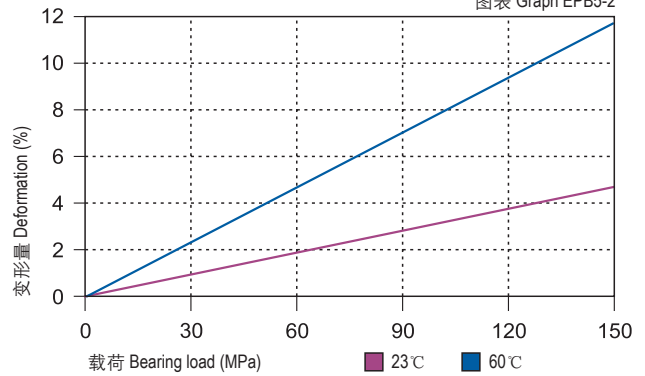

载荷-温度图表 Load-Temperature diagrams

图表 Graph EPB5-3

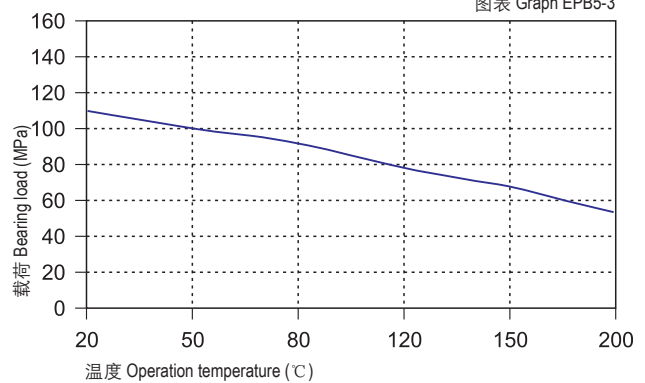

摩擦系数与速度变化关系图表 P=2MPa

Coefficient of friction & the speed of bearing, p = 2 MPa

图表 Graph EPB5-4

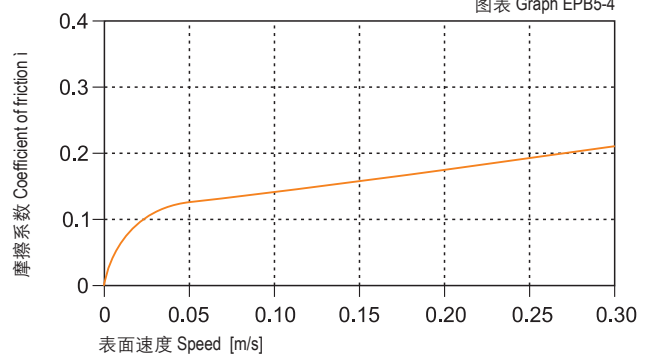

摩擦系数与载荷变化关系图表 v=0.2m/s

Coefficient of friction & the pressure of bearing, v = 0.2 m/s

图表 Graph EPB5-5

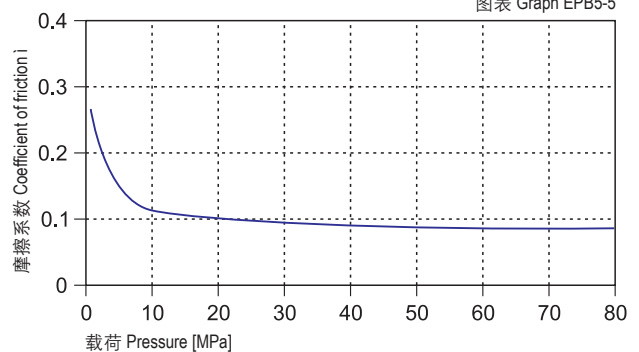

CSB-EPB10	干运行 Dry	油脂 Grease	油 Oil	水 Water
摩擦系数 μ Friction coef.	0.09~0.25	0.09	0.04	0.04

磨损与轴材料 Wearing and shaft material

图表EPB5-7和图表EPB5-8测试表明了CSB-EPB5塑料轴承在不同轴材料上的运行磨损对比，在载荷2Mpa以下旋转运动时不锈钢轴和碳钢轴比较适合，而当载荷超过2Mpa时在硬化钢轴和碳轴上的运行效果较好。图表EPB5-7表明CSB-EPB5塑料轴承比较适合用于旋转运动；特别值得注意的是图表EPB5-9表明CSB-EPB5塑料轴承在常温23℃下的摩擦磨损性能并没有在高温150℃下优秀。

Graph EPB5-7 and Graph EPB5-8 show the test results of the material CSB-EPB5 running against different shaft materials. It is suitable for stainless steel and hot rolled carbon steel shaft when the loading is less than 2Mpa and it will be more suitable for heat treated steel and carbon steel shaft when the loading is over 2Mpa. Graph EPB5-7 shows CSB-EPB5 is good for rotation operation. Specially, from the Graph EPB5-9, it is read that CSB-EPB5 is with better performance under high temperature around 150℃ comparing with under the ambient temperature of 23℃.

化学抗性 Chemical resistance

CSB-EPB5塑料轴承具有极好的化学抗性，能抵抗浓度65%的强酸。

Chemical Resistance of CSB-EPB5 is very good. It can work well in the heavy acid of 65%.

吸水性 Water absorption

CSB-EPB5塑料轴承在标准大气中的吸湿率为0.1%。浸泡在水中的最高吸水率为0.5%。极低吸水率不会导致轴承发生性能和尺寸变化，非常适合用于潮湿环境。

The moisture absorption of CSB-EPB5 plastic plain bearings is 0.1% in standard atmosphere. The max. water absorption is 0.5% in water. These values are very low, CSB-EPB5 plastic plain bearings is very well suited for used in wet applications.

抗UV性能 UV resistance

CSB-EPB5塑料轴承长久暴露在紫外线下材料性能不会发生变化。

CSB-EPB5 can maintain its performance to be stable even exposed in the UV ray for long period.

安装公差 Installation tolerances

CSB-EPB5 塑料轴承压装后公差 Tolerances after pressfit

直径 Di. [mm]	CSB-EPB5 F10 [mm]	座孔 Housing H7 [mm]	轴 Shaft h9 [mm]
>0 ~ 3	+0.006 ~ +0.046	0 ~ +0.010	0 ~ -0.025
>3 ~ 6	+0.010 ~ +0.058	0 ~ +0.012	0 ~ -0.030
>6 ~ 10	+0.013 ~ +0.071	0 ~ +0.015	0 ~ -0.036
>10 ~ 18	+0.016 ~ +0.086	0 ~ +0.018	0 ~ -0.043
>18 ~ 30	+0.020 ~ +0.104	0 ~ +0.021	0 ~ -0.052
>30 ~ 50	+0.025 ~ +0.125	0 ~ +0.025	0 ~ -0.062
>50 ~ 80	+0.030 ~ +0.150	0 ~ +0.030	0 ~ -0.074
>80 ~ 120	+0.036 ~ +0.176	0 ~ +0.035	0 ~ -0.087

在不同轴材料上旋转时的磨损量 $p=2\text{MPa}$, $v=0.2\text{m/s}$

Wear under rotating with different shaft materials, $p = 2 \text{ MPa}$, $v = 0.2 \text{ m/s}$

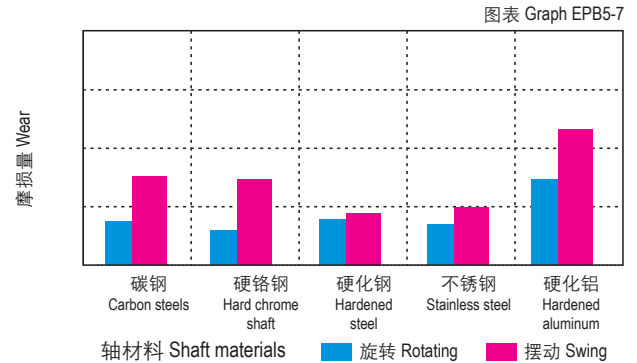

旋转磨损随轴材料与压力变化关系 $v=0.2\text{m/s}$

Wear & pressure under rotating with different shaft materials, $v = 0.2 \text{ m/s}$

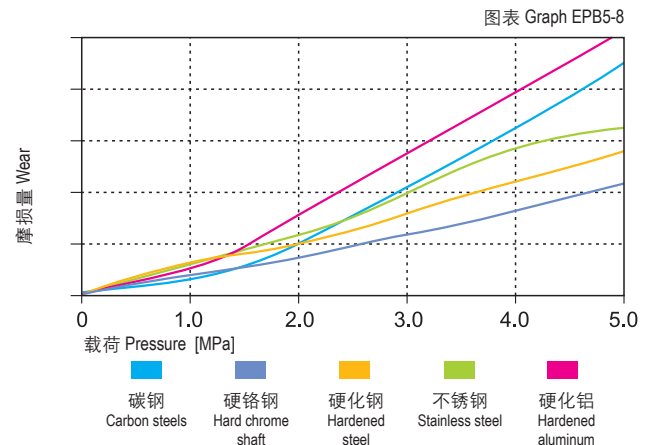

在不同温度下的磨损量 $p=2\text{MPa}$ $v=0.2\text{m/s}$

The bearing wear under rotating with different temperature $p = 2 \text{ MPa}$ $v = 0.2 \text{ m/s}$

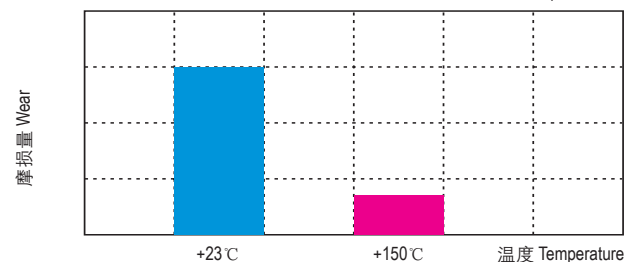

吸水性的影响 Effect of moisture absorption on EPB5 bearings

Effect of moisture absorption on EPB5 bearings

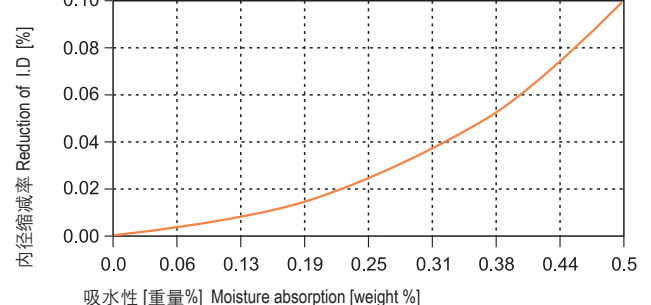



产品特性 Product features

- 连续使用温度: -100°C/+250°C
- 适合高载荷低速运用
- 高温下保持较高的承载能力
- 较广泛的化学抗性
- 符合FDA标准
- Continuous working temperature: -100°C/+250°C
- Suitable for high load and low speed operation
- High load capacity at higher temperature
- Good chemical resistance
- FDA grade

● 标准产品规格表 Standard specifications: P135

材料数据表 Material properties data table

材料性能 Material properties	测试标准 Standard	单位 Unit	CSB-EPB5A
颜色 Color	-	-	米色 Beige
密度 Density	ISO1183	g/cm ³	1.28
最大吸湿率 Max. moisture absorption, 50%RH	ISO62	%	0.3
最大吸水率 Max. water absorption	ISO62	%	0.5
对钢动摩擦系数 Coefficient of sliding friction(steel)	ITS025	μ	0.25-0.40
极限PV值 Max. PV value	ITS026	N/mm ² × m/s	0.25
弯曲模量 Flexural modulus	ISO178	MPa	3600
弯曲强度 Flexural strength	ISO178	MPa	140
最大静载荷 Max. static load	ITS027	MPa	90
最大动载荷 Max. dynamic load	ITS028	MPa	46
邵氏硬度 Shore hardness	ISO868	D	80
连续运行温度 Long-term application temperature	ITS029	°C	+250
短时运行温度 Short-term application temperature	ITS029	°C	+300
最低运行温度 Lowest application temperature	ITS029	°C	-100
导热性 Thermal conductivity	ISO22007	W/m/K	0.24
线性热膨胀系数 Coefficient of thermal expansion	ISO11359	K ⁻¹ × 10 ⁻⁵	9
阻燃等级 Flammability	UL94	Class	V0
体电阻率 Volume resistance	IEC60093	Ω · cm	>10 ¹⁴
面电阻率 Surface resistance	IEC60093	Ω	>10 ¹³

*ITS: CSB内部测试标准 CSB company's internal test standards.

**除非特殊说明测试温度为23°C Test temperatures are 23°C unless otherwise stated.

轴承PV值 PV value

CSB-EPB5A塑料轴承最大运行PV值为0.25N/mm² × m/s; 由此决定轴承所承受的载荷与速度成反比, 详细查阅图表EPB5A-1。

The max PV value of the CSB-EPB5A plastic bearings is 0.25N/mm² × m/s which determines the load capacity of bearing is inversely proportional to the speed. Please refer to the chart for more detailed information (Graph EPB5A-1).

■ PV图表 Permissible PV value for CSB-EPB5A

图表 Graph EPB5A-1

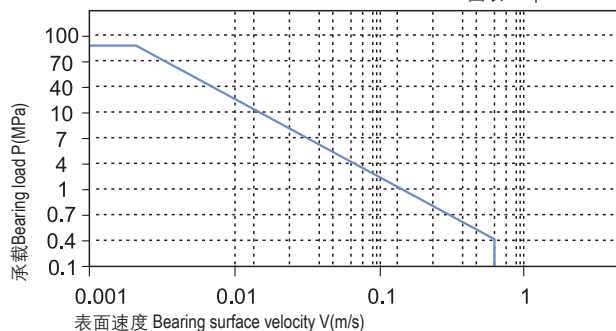

轴承的载荷、速度、温度 Load, speed and temperature

CSB-EPB5A塑料轴承可承受最大静载荷为90Mpa, 在此载荷下轴承的最大压缩变形量参考图表EPB5A-2, 轴承实际工作载荷略小于90Mpa, 载荷还受到运行速度以及温度的影响, 速度越快 (Vmax: 0.6m/s) 会导致摩擦温度上升, 而温度上升 (Tmax: 250℃) 会导致轴承的承载能力逐渐减弱, 载荷随轴承工作温度变化情况参考图表EPB5A-3。

CSB-EPB5A allows the Max static load of 90Mpa, The max compressive deformation rate under the max load is listed in Graph EPB5A-2, The actual load capacity of bearing is slightly less than 90Mpa, The bearing load is variable against the speed and temperature, Fast speed (Vmax: 0.6m/s) results into higher temperature (Tmax: 250℃) which decreases the load capacity of the bearing. Please refer to the Graph EPB5A-3 for such variation.

轴承的摩擦系数、磨损、轴材料 Friction factor, wear and shaft material

摩擦系数 Friction factor

图表EPB5A-4表明CSB-EPB5A塑料轴承在载荷一定时摩擦系数随着运动速度的增加而逐渐升高; 图表EPB5A-5表明CSB-EPB5A塑料轴承在速度一定载荷在20Mpa以内时摩擦系数会随着载荷的逐步增加而快速降低, 而当载荷高于20Mpa时摩擦系数的变化却比较平缓。图表EPB5A-6表明CSB-EPB5A塑料轴承比较适合轴表面粗糙度为Ra0.4 ~ 0.9um。

CSB-EPB5A Bearing Friction factor is increased along with the increasing of the operation speed under certain loading (See Graph EPB5A-4). The friction factor of CSB-EP5A is decreased along with the loading increasing not over 20Mpa (see Graph EPB5A-5). The friction factor will not change much along with the speed when the loading is over 20Mpa. The Graph EPB5A-6 shows that the bearing could achieve its best performance when the counter shaft surface roughness is around Ra0.4 to Ra0.9.

摩擦系数与轴表面粗糙度关系图表 Coefficient of friction & the surface roughness of shaft

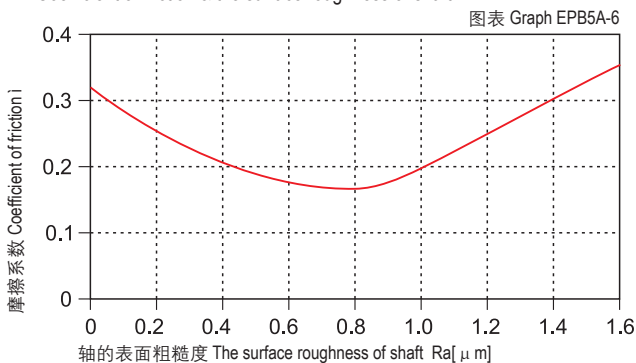

载荷-温度-变形量图表 Load-Temperature deformation

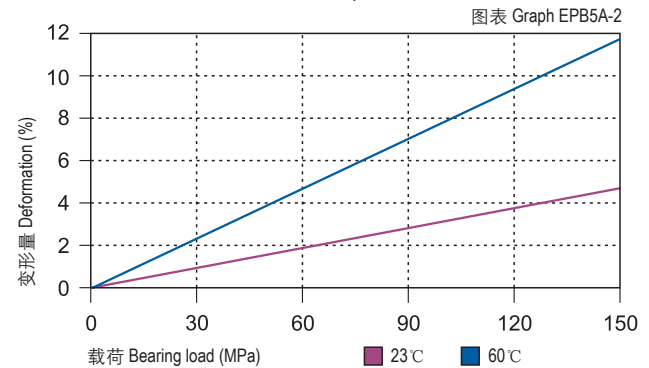

载荷-温度图表 Load-Temperature diagrams

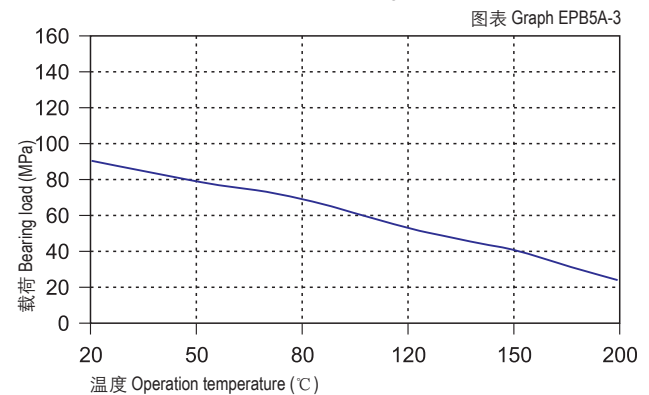

摩擦系数与速度变化关系图表 P=2MPa Coefficient of friction & the speed of bearing, p = 2 MPa

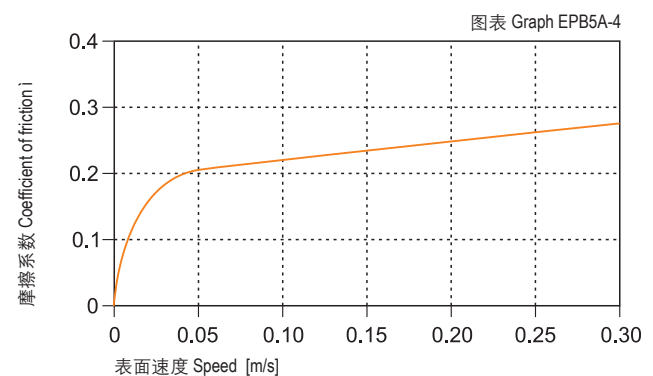

摩擦系数与载荷变化关系图表 v=0.2m/s Coefficient of friction & the pressure of bearing, v = 0.2 m/s

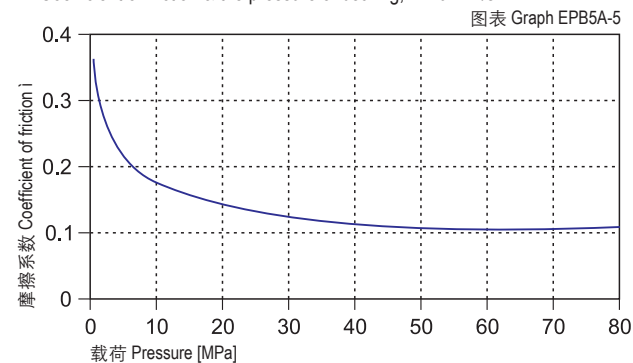

CSB-EPB5A	干运行 Dry	油脂 Grease	油 Oil	水 Water
摩擦系数 μ Friction coef.	0.25-0.40	0.09	0.04	0.04

磨损与轴材料 Wearing and shaft material

图表EPB5A-7和图表EPB5A-8测试表明了CSB-EPB5A塑料轴承在不同轴材料上的运行磨损情况，这表明此轴承在轻载下使用硬化铝轴和硬铬轴比较适合，而随着载荷的增加硬铬轴的优势尤为突出。图表EPB5A-7表明CSB-EPB5A塑料轴承比较适合用于摆动运动。

Graph EPB5A-7 and Graph EPB5A-8 show the test results of the material CSB-EPB5A running against different shaft materials. It is suitable for hard Aluminum and hard chrome steel shaft. The hard chrome steel shaft will be better when the loading is getting heavier. Graph EPB5A-7 shows CSB-EPB5A is good for oscillation operation.

化学抗性 Chemical resistance

CSB-EPB5A塑料轴承具有极好的化学抗性，能抵抗浓度65%的强酸。

Chemical Resistance of CSB-EPB5A is very good. It can work well in the heavy acid of 65%.

吸水性 Water absorption

CSB-EPB5A塑料轴承在标准大气中的吸湿率为0.3%。浸泡在水中的最高吸水率为0.5%。极低吸水率不会导致轴承发生性能和尺寸变化，非常适合用于潮湿环境。

The moisture absorption of CSB-EPB5A plastic plain bearings is 0.3% in standard atmosphere. The max. water absorption is 0.5% in water. These values are very low, CSB-EPB5A plastic plain bearings is very well suited for used in wet applications.

抗UV性能 UV resistance

CSB-EPB5A塑料轴承长久暴露在紫外线下材料性能不会发生变化。

CSB-EPB5A can maintain its performance to be stable even exposed in the UV ray for long period.

安装公差 Installation tolerances

CSB-EPB5A塑料轴承压装后公差 Tolerances after pressfit

直径 Di [mm]	CSB-EPB5A F10 [mm]	座孔 Housing H7 [mm]	轴 Shaft h9 [mm]
>0 ~ 3	+0.006 ~ +0.046	0 ~ +0.010	0 ~ -0.025
>3 ~ 6	+0.010 ~ +0.058	0 ~ +0.012	0 ~ -0.030
>6 ~ 10	+0.013 ~ +0.071	0 ~ +0.015	0 ~ -0.036
>10 ~ 18	+0.016 ~ +0.086	0 ~ +0.018	0 ~ -0.043
>18 ~ 30	+0.020 ~ +0.104	0 ~ +0.021	0 ~ -0.052

在不同轴材料上旋转时的磨损量 $p=2\text{MPa}$, $v=0.2\text{m/s}$

Wear under rotating with different shaft materials, $p = 2 \text{ MPa}$, $v = 0.2 \text{ m/s}$

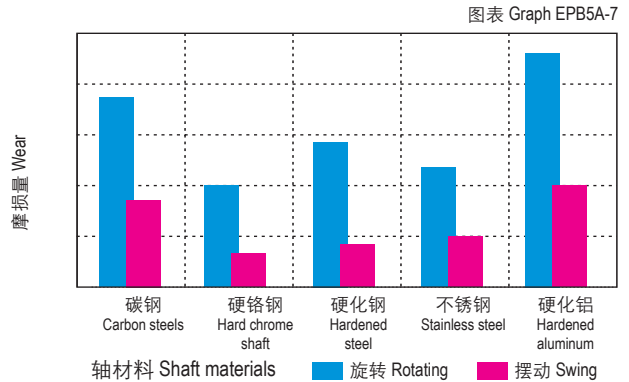

旋转磨损随轴材料与压力变化关系 $v=0.2\text{m/s}$

Wear & pressure under rotating with different shaft materials, $v = 0.2 \text{ m/s}$

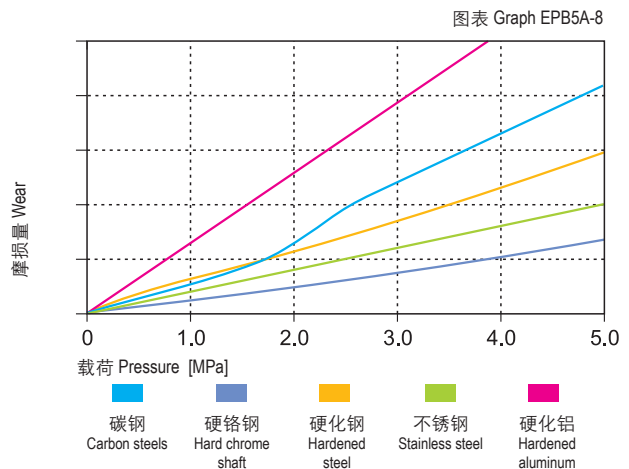

吸水性的影响 Effect of moisture absorption on EPB5A bearings

图表 Graph EPB5A-9

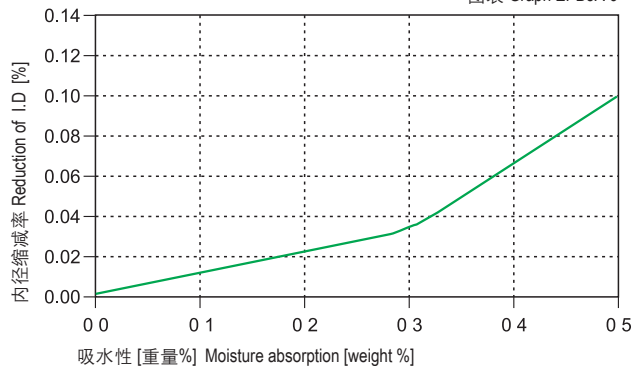

直径 Di [mm]	CSB-EPB5A F10 [mm]	座孔 Housing H7 [mm]	轴 Shaft h9 [mm]
>30 ~ 50	+0.025 ~ +0.125	0 ~ +0.025	0 ~ -0.062
>50 ~ 80	+0.030 ~ +0.150	0 ~ +0.030	0 ~ -0.074
>80 ~ 120	+0.036 ~ +0.176	0 ~ +0.035	0 ~ -0.087
>120 ~ 180	+0.043 ~ +0.203	0 ~ +0.040	0 ~ -0.100

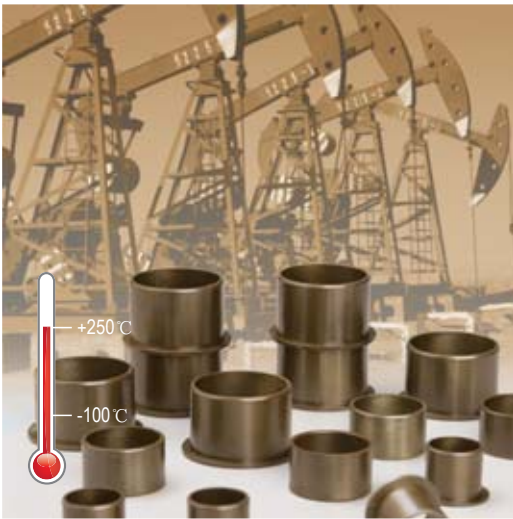

产品特性 Product features

- 高载荷和低摩擦系数出色的材料。可承受边缘载荷。软轴或硬轴配合使用同样耐磨
- 连续使用温度: -100°C/+250°C
- 适合高载荷运动
- 允许较高的运行速度
- 允许边界压力
- 摆动运行性能尤为出色
- It is a high load material with excellent low friction factor. Marginal load application is acceptable and it is with good wear resistance both for hard and soft shafts
- Continuous working temperature: -100°C/+250°C
- High load capacity
- Higher speed is permissible
- Marginal pressure is permissible
- Best performance for oscillating movement

● 标准产品规格表 Standard specifications: P135

材料数据表 Material properties data table

材料性能 Material properties	测试标准 Standard	单位 Unit	CSB-EPB5Z
颜色 Color	-	-	棕色 Brown
密度 Density	ISO1183	g/cm ³	1.40
最大吸湿率 Max. moisture absorption, 50%RH	ISO62	%	0.3
最大吸水率 Max. water absorption	ISO62	%	1.1
对钢动摩擦系数 Coefficient of sliding friction(steel)	ITS025	μ	0.05-0.15
极限PV值 Max. PV value	ITS026	N/mm ² × m/s	1.00
弯曲模量 Flexural modulus	ISO178	MPa	4200
弯曲强度 Flexural strength	ISO178	MPa	150
最大静载荷 Max. static load	ITS027	MPa	100
最大动载荷 Max. dynamic load	ITS028	MPa	51
邵氏硬度 Shore hardness	ISO868	D	80
连续运行温度 Long-term application temperature	ITS029	°C	+250
短时运行温度 Short-term application temperature	ITS029	°C	+310
最低运行温度 Lowest application temperature	ITS029	°C	-100
导热性 Thermal conductivity	ISO22007	W/m/K	0.55
线性热膨胀系数 Coefficient of thermal expansion	ISO11359	K ⁻¹ × 10 ⁻⁵	5
阻燃等级 Flammability	UL94	Class	V0
体电阻率 Volume resistance	IEC60093	Ω · cm	>10 ¹¹
面电阻率 Surface resistance	IEC60093	Ω	>10 ¹¹

*ITS: CSB内部测试标准 CSB company's internal test standards.

**除非特殊说明测试温度为23°C Test temperatures are 23°C unless otherwise stated.

轴承PV值 PV value

CSB-EPB5Z塑料轴承最大运行PV值为1.0N/mm² × m/s; 由此决定轴承所承受的载荷与速度成反比, 详细查阅图表EPB5Z-1。

The max PV value of the CSB-EPB5Z plastic bearings is 1.0N/mm² × m/s which determines the load capacity of bearing is inversely proportional to the speed. Please refer to the chart for more detailed information (Graph EPB5Z-1).

■ PV图表 Permissible PV value for CSB-EPB5Z

图表 Graph EPB5Z-1

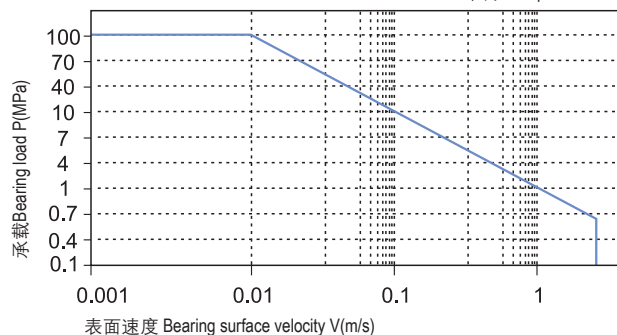

轴承的载荷、速度、温度 Load, speed and temperature

CSB-EPB5Z塑料轴承可承受最大静载荷为100Mpa，在此载荷下轴承的最大压缩变形量参考图表EPB5Z-2，轴承实际工作载荷略小于100Mpa，载荷还受到运行速度以及温度的影响，速度越快 (Vmax: 1.5m/s) 会导致摩擦温度上升，而温度上升 (Tmax: 250℃) 会导致轴承的承载能力逐渐减弱，载荷随轴承工作温度变化情况参考图表EPB5Z-3。

CSB-EPB5Z allows the Max static load of 100Mpa, The max compressive deformation rate under the max load is listed in Graph EPB5Z-2, The actual load capacity of bearing is slightly less than 100Mpa, The bearing load is variable against the speed and temperature, Fast speed (Vmax: 1.5m/s) results into higher temperature (Tmax: 250℃) which decreases the load capacity of the bearing. Please refer to the Graph EPB5Z-3 for such variation.

轴承的摩擦系数、磨损、轴材料 Friction factor, wear and shaft material

摩擦系数 Friction factor

图表EPB5Z-4表明CSB-EPB5Z塑料轴承在载荷保持不变的情况下轴承的摩擦系数随着旋转速度的增加而先随之升高，当速度值达到0.2m/s后又随着速度的增加而降低；图表EPB5Z-5表明CSB-EPB5Z塑料轴承的摩擦系数在旋转速度保持不变的情况下随着载荷的不断上升而逐渐降低。图表EPB5Z-6表明CSB-EPB5Z塑料轴承对磨轴的粗糙度在Ra0.4 ~ 0.7μm时最适合的。

Graph EPB5Z-4 shows that the friction factor of CSB-EPB5Z is initially increased along with the operation speed increasing when the loading is stable but when the speed reaches over 0.2m/s, it is decreased along with the operation speed increasing. Graph EPB5Z-5 shows that the friction factor of CSB-EPB5Z is decreasing along with the loading increasing when the operation speed is stable. The best shaft roughness for this material is Ra0.4~0.7.

摩擦系数与轴表面粗糙度关系图表

Coefficient of friction & the surface roughness of shaft

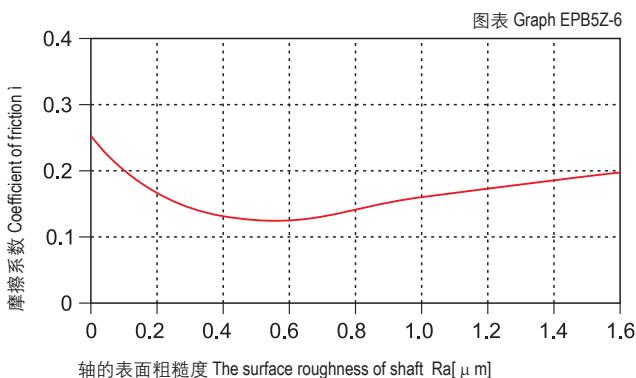

载荷-温度-变形量图表 Load-Temperature deformation

图表 Graph EPB5Z-2

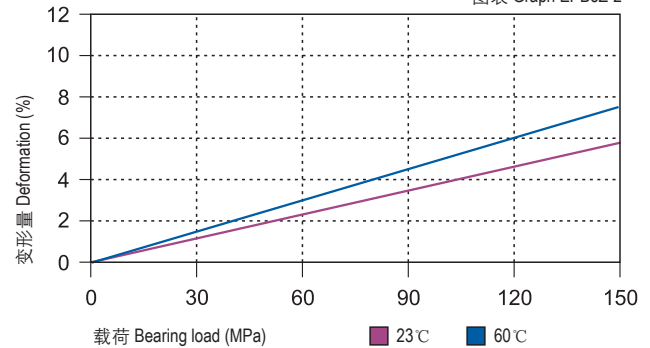

载荷-温度图表 Load-Temperature diagrams

图表 Graph EPB5Z-3

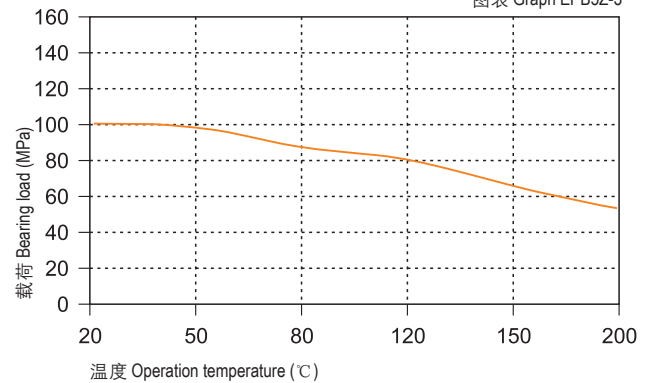

摩擦系数与速度变化关系图表 P=2MPa

Coefficient of friction & the speed of bearing, p = 2 MPa

图表 Graph EPB5Z-4

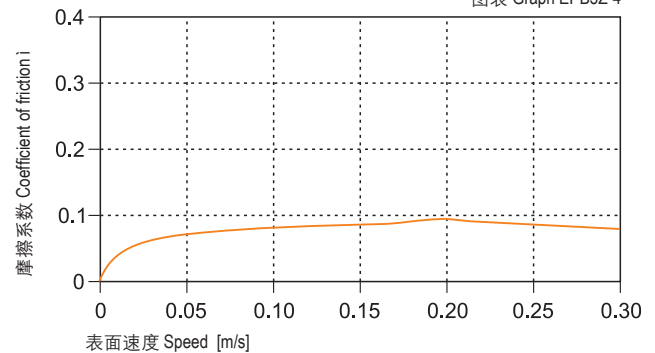

摩擦系数与载荷变化关系图表 v=0.2m/s

Coefficient of friction & the pressure of bearing, v = 0.2 m/s

图表 Graph EPB5Z-5

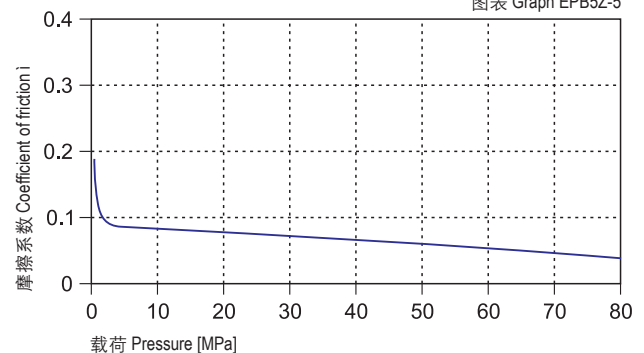

CSB-EPB5Z	干运行 Dry	油脂 Grease	油 Oil	水 Water
摩擦系数 μ Friction coef.	0.05-0.15	0.09	0.04	0.04

磨损与轴材料 Wearing and shaft material

图表EPB5Z-7与图表EPB5Z-8表明CSB-EPB5Z塑料轴承在低载下的磨损速率和其它轴承类似，而在中高载荷时此轴承的耐磨性要比其它轴承都要好；同时我们可以看出硬化轴比较适合用于CSB-EPB5Z塑料轴承。图表EPB5Z-7表明CSB-EPB5Z塑料轴承在摆动下的磨损要比旋转下的要小，当载荷超过20Mpa时这种现象尤为明显。在旋转运动下我们推荐使用硬化钢轴比较适合，而在摆动运动下我们建议采用不锈钢轴或硬铬钢轴比较理想。

Graph EPB5Z-7 and Graph EPB5Z-8 shows that the wearing speed of CSB-EPB5Z is similar with most of the other materials under lower loading but it will be much better when the loading is higher. It also tells that the hardened steel shaft is good for CSB-EPB5Z bearings. Graph EPB5Z-7 shows the wearing rate is less in oscillation operation than in rotation operation especially when the loading is over 20Mpa. Heat-treated steel shaft is recommended in rotation operation and stainless steel and hardened chrome steel shaft is recommended in oscillation operation.

化学抗性 Chemical resistance

CSB-EPB5Z塑料轴承可以抵抗弱酸、弱碱以及各类润滑油的腐蚀。CSB-EPB5Z is good at chemical resistance against mild base, weak acidic medium and various kinds of lubricants.

吸水性 Water absorption

CSB-EPB5Z塑料轴承在标准大气中的吸湿率为0.3%。浸泡在水中最高吸水率为1.1%。较低的吸水率只有在极端应用中才需要更改轴承设计。

The moisture absorption of CSB-EPB5Z plastic bearings is 0.3% in standard atmosphere. The max. water absorption is 1.1% in water. These values are so low that design changes due to absorption are only necessary in extreme applications.

抗UV性能 UV resistance

CSB-EPB5Z塑料轴承长久暴露在紫外线下材料性能会逐渐下降。

The material performance of CSB-EP5Z will be lowered if it is exposed in the UV ray for long period.

安装公差 Installation tolerances

CSB-EPB5Z塑料轴承压装后公差 Tolerances after pressfit

直径 Di. [mm]	CSB-EPB5Z F10 [mm]	座孔 Housing H7 [mm]	轴 Shaft h9 [mm]
>0 ~ 3	+0.006 ~ +0.046	0 ~ +0.010	0 ~ -0.025
>3 ~ 6	+0.010 ~ +0.058	0 ~ +0.012	0 ~ -0.030
>6 ~ 10	+0.013 ~ +0.071	0 ~ +0.015	0 ~ -0.036

在不同轴材料上旋转时的磨损量 $p=2\text{MPa}$, $v=0.2\text{m/s}$

Wear under rotating with different shaft materials, $p = 2 \text{ MPa}$, $v = 0.2 \text{ m/s}$

图表 Graph EPB5Z-7

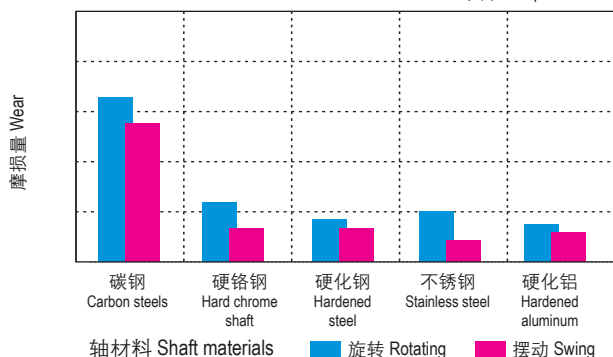

旋转磨损随轴材料与压力变化关系 $v=0.2\text{m/s}$

Wear & pressure under rotating with different shaft materials, $v = 0.2 \text{ m/s}$

图表 Graph EPB5Z-8

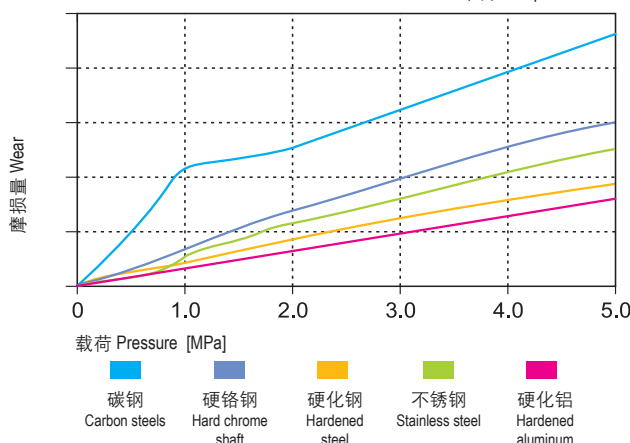

吸水性的影响 Effect of moisture absorption on EPB5Z bearings

图表 Graph EPB5Z-9

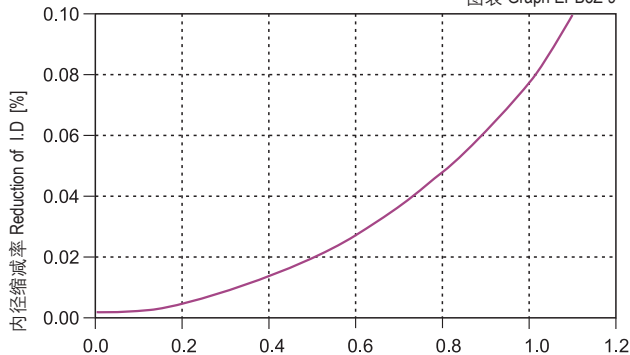

直径 Di. [mm]	CSB-EPB5Z F10 [mm]	座孔 Housing H7 [mm]	轴 Shaft h9 [mm]
>10 ~ 18	+0.016 ~ +0.086	0 ~ +0.018	0 ~ -0.043
>18 ~ 30	+0.020 ~ +0.104	0 ~ +0.021	0 ~ -0.052
>30 ~ 50	+0.025 ~ +0.125	0 ~ +0.025	0 ~ -0.062
>50 ~ 80	+0.030 ~ +0.150	0 ~ +0.030	0 ~ -0.074
>80 ~ 120	+0.036 ~ +0.176	0 ~ +0.035	0 ~ -0.087
>120 ~ 180	+0.043 ~ +0.203	0 ~ +0.040	0 ~ -0.100



● 标准产品规格表 Standard specifications: P124

产品特性 Product features

- 80度下较好的耐磨材料。被应用于对轴硬度要求不高的场合。白色也是较多清洁设备和包装机械的考虑因素
- 连续使用温度: -40℃/+80℃
- 对轴表面粗糙度要求低
- 较低的摩擦系数
- 适用于软轴
- It is a wear resistance material for working temperature lower than 80℃. The application is for the condition where the shaft hardness is not critical. The white color of the material is also commonly used for most of the clearing and packing machineries
- Continuous working temperature: -40℃/+80℃
- No special requirement on the surface roughness
- Low friction coefficient
- Applicable for soft shaft

材料数据表 Material properties data table

材料性能 Material properties	测试标准 Standard	单位 Unit	CSB-EPB6
颜色 Color	-	-	白色 White
密度 Density	ISO1183	g/cm ³	1.45
最大吸湿率 Max. moisture absorption, 50%RH	ISO62	%	0.3
最大吸水率 Max. water absorption	ISO62	%	1.2
对钢动摩擦系数 Coefficient of sliding friction(steel)	ITS025	μ	0.05-0.18
极限PV值 Max. PV value	ITS026	N/mm ² × m/s	0.30
弯曲模量 Flexural modulus	ISO178	MPa	2300
弯曲强度 Flexural strength	ISO178	MPa	60
最大静载荷 Max. static load	ITS027	MPa	35
最大动载荷 Max. dynamic load	ITS028	MPa	14
邵氏硬度 Shore hardness	ISO868	D	74
连续运行温度 Long-term application temperature	ITS029	℃	+80
短时运行温度 Short-term application temperature	ITS029	℃	+120
最低运行温度 Lowest application temperature	ITS029	℃	-40
导热性 Thermal conductivity	ISO22007	W/m/K	0.20
线性热膨胀系数 Coefficient of thermal expansion	ISO11359	K ⁻¹ × 10 ⁻⁵	10
阻燃等级 Flammability	UL94	Class	HB
体电阻率 Volume resistance	IEC60093	Ω · cm	>10 ¹³
面电阻率 Surface resistance	IEC60093	Ω	>10 ¹²

*ITS: CSB内部测试标准 CSB company's internal test standards.

**除非特殊说明测试温度为23℃ Test temperatures are 23℃ unless otherwise stated.

轴承PV值 PV value

CSB-EPB6塑料轴承最大运行PV值为0.3N/mm² × m/s; 由此决定轴承所承受的载荷与速度成反比, 详细查阅图表EPB6-1。

The max PV value of the CSB-EPB6 plastic bearings is 0.3N/mm² × m/s which determines the load capacity of bearing is inversely proportional to the speed. Please refer to the chart for more detailed information (Graph EPB6-1).

■ PV图表 Permissible PV value for CSB-EPB6

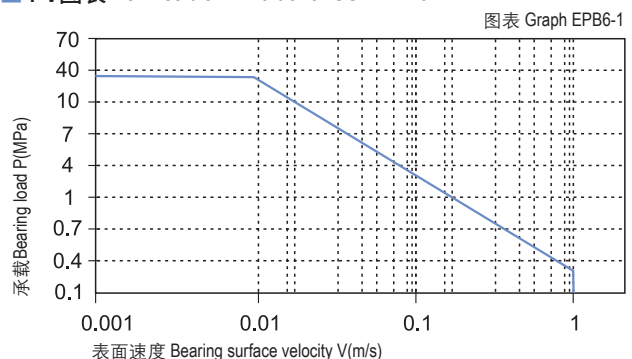

轴承的载荷、速度、温度 Load, speed and temperature

CSB-EPB6塑料轴承可承受最大静载荷为35Mpa，在此载荷下轴承的最大压缩变形量参考图表EPB6-2，轴承实际工作载荷略小于35Mpa，载荷还受到运行速度以及温度的影响，速度越快 (Vmax: 1.0m/s) 会导致摩擦温度上升，而温度上升 (Tmax: 80℃) 会导致轴承的承载能力逐渐减弱，载荷随轴承工作温度变化情况参考图表EPB6-3。

CSB-EPB6 allows the Max static load of 35Mpa, The max compressive deformation rate under the max load is listed in Graph EPB6-2, The actual load capacity of bearing is slightly less than 35Mpa, The bearing load is variable against the speed and temperature, Fast speed (Vmax: 1.0m/s) results into higher temperature (Tmax: 80℃) which decreases the load capacity of the bearing. Please refer to the Graph EPB6-3 for such variation.

轴承的摩擦系数、磨损、轴材料 Friction factor, wear and shaft material

摩擦系数 Friction factor

图表EPB6-4表明CSB-EPB6塑料轴承在载荷保持不变的情况下摩擦系数随着运行速度的增加而略有小幅度的升高；图表EPB6-5表明CSB-EPB6塑料轴承在保持速度不变时摩擦系数随着载荷的增加而逐步减低。根据图表EPB6-6表明CSB-EPB6塑料轴承的摩擦系数会随着轴表面粗糙度的变化而不同，我们推荐使用轴粗糙度为Ra0.3 ~ 0.6μm；

Graph EPB6-4 shows the CSB-EPB6 friction factor is slightly increased as long as the operation speed increasing when the loading is relatively stable. Graph EPB6-5 shows the friction factor of CSB-EPB6 is continuing decreasing along with the loading increasing when the operation speed is relatively stable. From Graph EPB6-6, it is found that the friction factor is also variable against the shaft surface roughness. The recommended shaft surface roughness is Ra0.3~0.6.

摩擦系数与轴表面粗糙度关系图表 Coefficient of friction & the surface roughness of shaft

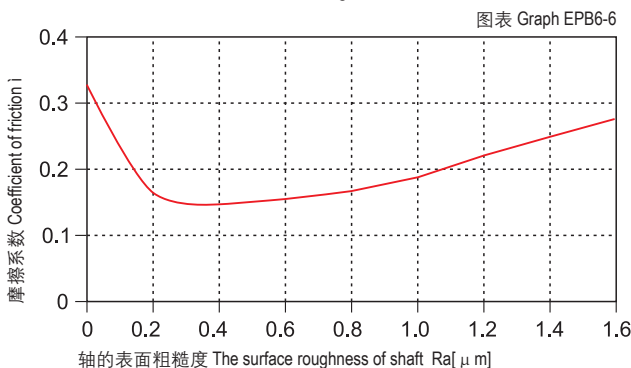

载荷-温度-变形量图表 Load-Temperature deformation

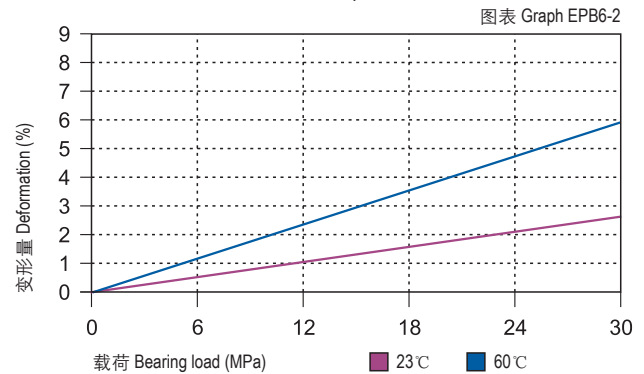

载荷-温度图表 Load-Temperature diagrams

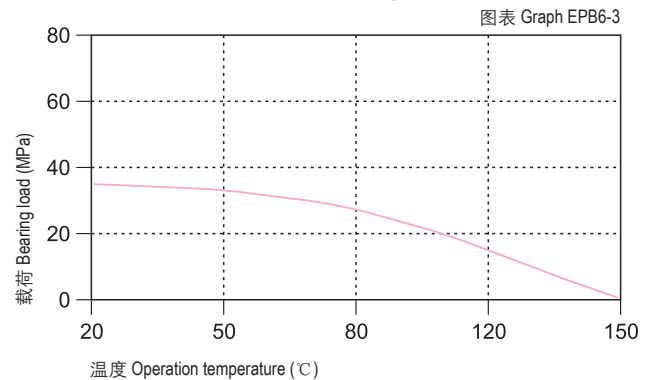

摩擦系数与速度变化关系图表 P=2MPa Coefficient of friction & the speed of bearing, p = 2 MPa

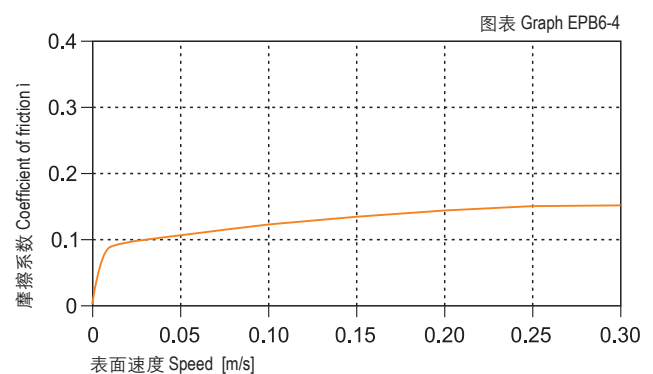

摩擦系数与载荷变化关系图表 v=0.2m/s Coefficient of friction & the pressure of bearing, v = 0.2 m/s

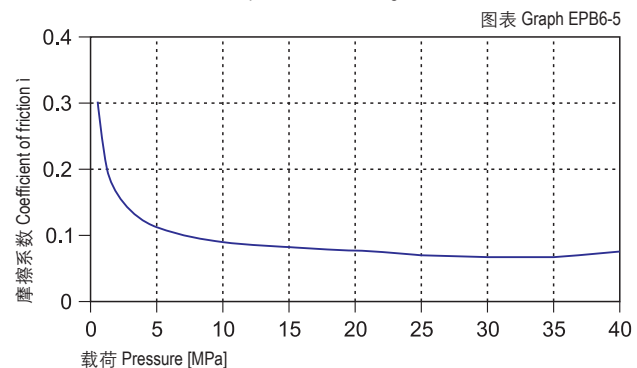

CSB-EPB6	干运行 Dry	油脂 Grease	油 Oil	水 Water
摩擦系数 μ Friction coef.	0.05-0.18	0.09	0.04	0.04

磨损与轴材料 Wearing and shaft material

图表EPB6-7与图表EPB6-8表明硬化钢轴或硬铬钢轴比较适合用于CSB-EPB6塑料轴承。CSB-EPB6塑料轴承在用于旋转运动或摆动运动时的磨损性能基本相同，这就决定了此轴承可以用于多种场合。

Graph EPB6-7 and Graph EPB6-8 describes CSB-EPB6 bearing is suitable for hardened steel and hardened chrome steel shaft. CSB-EPB6 is very similar during its rotation operation and oscillation operation so that this material is suitable for most of the applications.

化学抗性 Chemical resistance

CSB-EPB6塑料轴承能抵抗弱碱、弱酸以及各类润滑油的腐蚀。CSB-EPB6 is good at chemical resistance against mild base, weak acidic medium and various kinds of lubricants.

吸水性 Water absorption

CSB-EPB6塑料轴承在标准大气中的吸湿率为0.3%。浸泡在水中最高吸水率为1.2%。较低的吸水率只有在极端应用中才需要更改轴承设计。

The moisture absorption of CSB-EPB6 plastic bearings is 0.3% in standard atmosphere. The max. water absorption is 1.2% in water. These values are so low that design changes due to absorption are only necessary in extreme applications.

抗UV性能 UV resistance

CSB-EPB6塑料轴承长久暴露在紫外线下颜色基本不会改变。材料的硬度，抗压强度和耐磨性都不会改变。

CSB-EPB6 can maintain its color unchanged when it is exposed into the UV ray. The hardness, Compressive strength and wear resistance of the material is also stable under such condition.

安装公差 Installation tolerances

CSB-EPB6塑料轴承压装后公差 Tolerances after pressfit

直径 Di. [mm]	CSB-EPB6 E10 [mm]	座孔 Housing H7 [mm]	轴 Shaft h9 [mm]
>0 ~ 3	+0.014 ~ +0.054	0 ~ +0.010	0 ~ -0.025
>3 ~ 6	+0.020 ~ +0.068	0 ~ +0.012	0 ~ -0.030
>6 ~ 10	+0.025 ~ +0.083	0 ~ +0.015	0 ~ -0.036
>10 ~ 18	+0.032 ~ +0.102	0 ~ +0.018	0 ~ -0.043
>18 ~ 30	+0.040 ~ +0.124	0 ~ +0.021	0 ~ -0.052
>30 ~ 50	+0.050 ~ +0.150	0 ~ +0.025	0 ~ -0.062
>50 ~ 80	+0.060 ~ +0.180	0 ~ +0.030	0 ~ -0.074
>80 ~ 120	+0.072 ~ +0.212	0 ~ +0.035	0 ~ -0.087
>120 ~ 180	+0.085 ~ +0.245	0 ~ +0.040	0 ~ -0.100

在不同轴材料上旋转时的磨损量 $p=2\text{MPa}$, $v=0.2\text{m/s}$ Wear under rotating with different shaft materials, $p = 2 \text{ MPa}$, $v = 0.2 \text{ m/s}$

图表 Graph EPB6-7

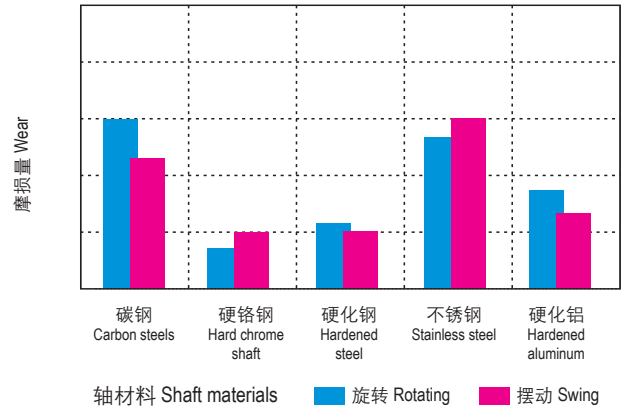

旋转磨损随轴材料与压力变化关系 $v=0.2\text{m/s}$ Wear & pressure under rotating with different shaft materials, $v = 0.2 \text{ m/s}$

Wear & pressure under rotating with different shaft materials, $v = 0.2 \text{ m/s}$

图表 Graph EPB6-8

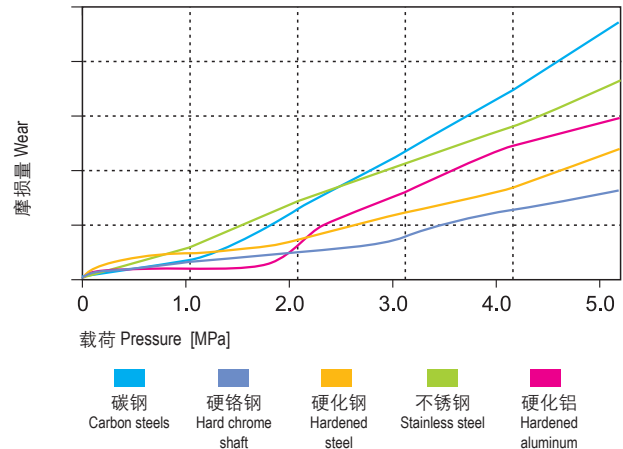

吸水性的影响 Effect of moisture absorption on EPB6 bearings

Effect of moisture absorption on EPB6 bearings

图表 Graph EPB6-9

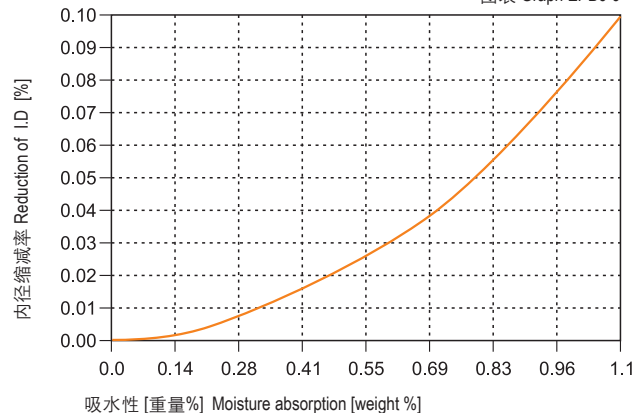

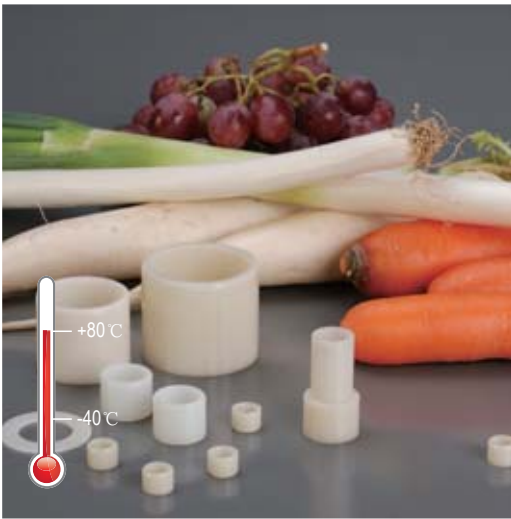

产品特性 Product features

- 不含PTFE和Silicon材料。应用于食品加工和包装工业
- 连续使用温度: -40℃/+80℃
- 对轴表面粗糙度要求低
- 较低的摩擦系数
- 适用于软轴
- FDA等级食品安全认证
- It is a PTFE and Silicon free material widely used in the food and packing machineries.
- Continuous working temperature: -40℃/+80℃
- No special requirement on the surface roughness
- Low friction coefficient
- Applicable for flexible shaft
- FDA grade

● 标准产品规格表 Standard specifications: P124

材料数据表 Material properties data table

材料性能 Material properties	测试标准 Standard	单位 Unit	CSB-EPB6A
颜色 Color	-	-	白色 White
密度 Density	ISO1183	g/cm ³	1.10
最大吸湿率 Max. moisture absorption, 50%RH	ISO62	%	1.5
最大吸水率 Max. water absorption	ISO62	%	7.6
对钢动摩擦系数 Coefficient of sliding friction(steel)	ITS025	μ	0.10-0.40
极限PV值 Max. PV value	ITS026	N/mm ² × m/s	0.10
弯曲模量 Flexural modulus	ISO178	MPa	1300
弯曲强度 Flexural strength	ISO178	MPa	55
最大静载荷 Max. static load	ITS027	MPa	35
最大动载荷 Max. dynamic load	ITS028	MPa	12
邵氏硬度 Shore hardness	ISO868	D	70
连续运行温度 Long-term application temperature	ITS029	℃	+80
短时运行温度 Short-term application temperature	ITS029	℃	+170
最低运行温度 Lowest application temperature	ITS029	℃	-40
导热性 Thermal conductivity	ISO22007	W/m/K	0.23
线性热膨胀系数 Coefficient of thermal expansion	ISO11359	K ⁻¹ × 10 ⁻⁵	11
阻燃等级 Flammability	UL94	Class	HB
体电阻率 Volume resistance	IEC60093	Ω · cm	>10 ¹³
面电阻率 Surface resistance	IEC60093	Ω	>10 ¹²

*ITS: CSB内部测试标准 CSB company's internal test standards.

**除非特殊说明测试温度为23℃ Test temperatures are 23℃ unless otherwise stated.

轴承PV值 PV value

CSB-EPB6A塑料轴承最大运行PV值为0.1N/mm² × m/s; 由此决定轴承所承受的载荷与速度成反比, 详细查阅图表EPB6A-1。

The max PV value of the CSB-EPB6A plastic bearings is 0.1N/mm² × m/s which determines the load capacity of bearing is inversely proportional to the speed. Please refer to the chart for more detailed information (Graph EPB6A-1).

■ PV图表 Permissible PV value for CSB-EPB6A

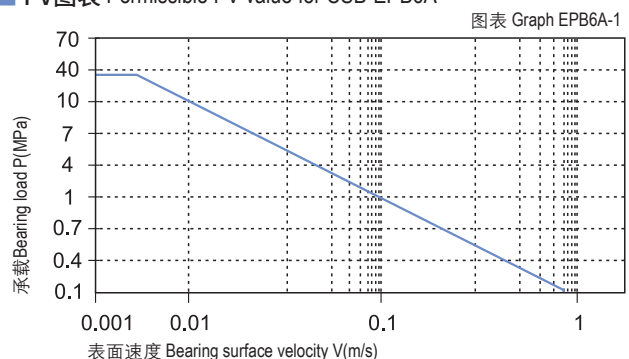

轴承的载荷、速度、温度 Load, speed and temperature

CSB-EP6A塑料轴承可承受最大静载荷为35Mpa，在此载荷下轴承的最大压缩变形量参考图表EPB6A-2，轴承实际工作载荷略小于35Mpa，载荷还受到运行速度以及温度的影响，速度越快 (Vmax: 0.6m/s) 会导致摩擦温度上升，而温度上升 (Tmax: 80℃) 会导致轴承的承载能力逐渐减弱，载荷随轴承工作温度变化情况参考图表EPB6A-3。

CSB-EP6A allows the Max static load of 35Mpa, The max compressive deformation rate under the max load is listed in Graph EPB6A-2, The actual load capacity of bearing is slightly less than 35Mpa, The bearing load is variable against the speed and temperature, Fast speed (Vmax: 0.6m/s) results into higher temperature (Tmax: 80℃) which decreases the load capacity of the bearing. Please refer to the Graph EPB6A-3 for such variation.

轴承的摩擦系数、磨损、轴材料 Friction factor, wear and shaft material

摩擦系数 Friction factor

图表EPB6A-4表明CSB-EP6A塑料轴承的摩擦系数在载荷一定的情况下随着运行速度的增加而快速升高；图表EPB6A-5表明CSB-EP6A塑料轴承在速度一定的情况下载荷低于10Mpa时摩擦系数随着载荷的增加而逐步降低，而当载荷高于10Mpa时摩擦系数的变化相对比较平缓。图表EPB6A-6表明CSB-EP6A塑料轴承的摩擦系数受轴表面粗糙度影响比较大，我们推荐使用轴表面粗糙度为Ra0.3 ~ 0.6um。

CSB-EP6A Bearing Friction factor is increased along with the increasing of the operation speed under certain loading (See Graph EPB6A-4). The friction factor of CSB-EP3M is decreased along with the loading increasing not over 10Mpa (see Graph EPB6A-5). The friction factor will not change much along with the speed when the loading is over 10Mpa. The Graph EPB6A-6 shows that the bearing could achieve its best performance when the counter shaft surface roughness is around Ra0.3 to Ra0.6.

摩擦系数与轴表面粗糙度关系图表

Coefficient of friction & the surface roughness of shaft

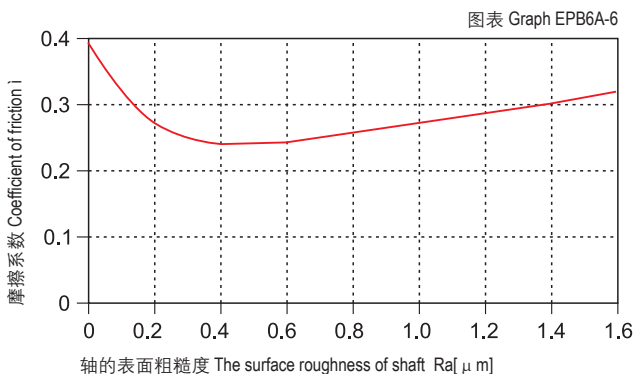

载荷-温度-变形量图表 Load-Temperature deformation

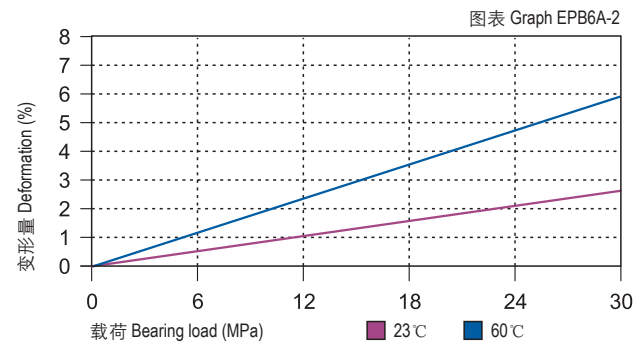

载荷-温度图表 Load-Temperature diagrams

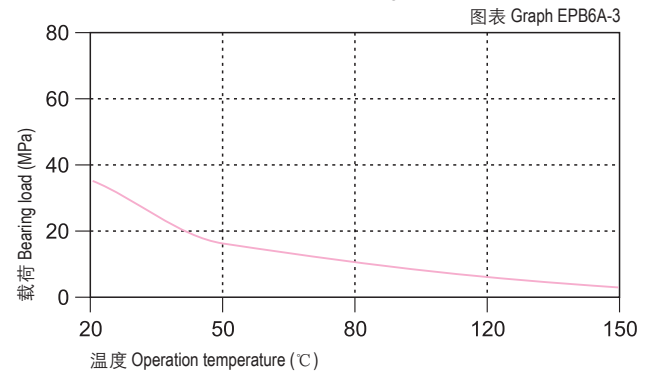

摩擦系数与速度变化关系图表 P=2MPa

Coefficient of friction & the speed of bearing, p = 2 MPa

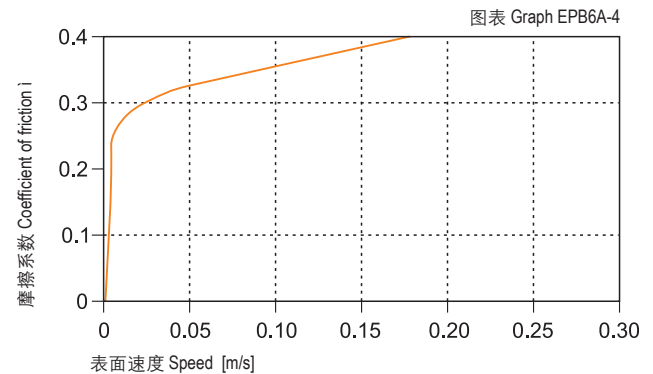

摩擦系数与载荷变化关系图表 v=0.2m/s

Coefficient of friction & the pressure of bearing, v = 0.2 m/s

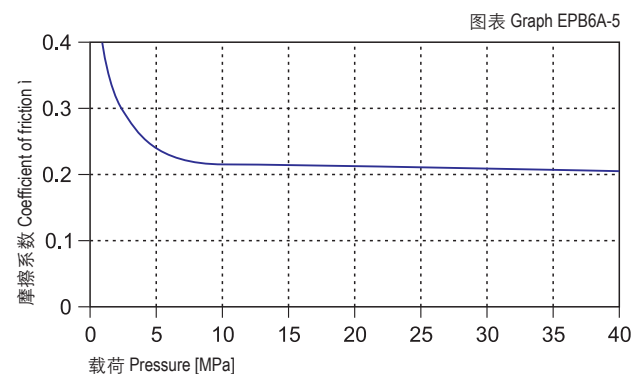

CSB-EPB6A	干运行 Dry	油脂 Grease	油 Oil	水 Water
摩擦系数 μ Friction coef.	0.10~0.40	0.09	0.04	0.04

磨损与轴材料 Wearing and shaft material

图表EPB6A-7与图表EPB6A-8为CSB-EPB6A塑料轴承在不同轴材料下旋转运动的结果，由此表明CSB-EPB6A塑料轴承磨损受轴材料影响比较大，通过试验结果我们推荐使用硬铬轴。图表EPB6A-7表明CSB-EPB6A塑料轴承在大多数情况下比较适合用于摆动，但当轴材料为硬铬钢时旋转运动效果是最佳的，而在做摆动运动时硬铬碳轴效果是更好的。

Graph EPB6A-7 and Graph EPB6A-8 show the test results of the material CSB-EPB6A running against different shaft materials. The test result induces that the wearing is considerably affected by the different shaft materials. It is recommended to use hard chrome steel shaft for this material. Graph EPB6A-7 shows CSB-EPB6A is commonly suitable for oscillation operation but it features well for the rotation operation when the shaft material is hard chrome and it is good for oscillation operation when the shaft material is carbon steel steel.

化学抗性 Chemical resistance

CSB-EPB6A塑料轴承能抵抗弱碱以及各类润滑油的腐蚀。
CSB-EPB6A is good at chemical resistance against weak acidic medium and various kinds of lubricants.

吸水性 Water absorption

CSB-EPB6A塑料轴承在标准大气中的吸湿率为1.5%。浸泡在水中最高吸水率为7.6%。由于高吸水率的特性，我们必须考虑此轴承的应用环境。

The moisture absorption of CSB-EPB6A plastic plain bearings is 1.5% in standard atmosphere. The max. water absorption is 7.6% in water. The application environment has to be considered due to the high water absorption properties.

抗UV性能 UV resistance

CSB-EPB6A塑料轴承长久暴露在紫外线下材料性能基本都不会发生改变。

When CSB-EPB6A is exposed into the UV ray, the material performance stays stable.

安装公差 Installation tolerances

CSB-EPB6A塑料轴承压装后公差 Tolerances after pressfit

直径 Di. [mm]	CSB-EPB6A E10 [mm]	座孔 Housing H7 [mm]	轴 Shaft h9 [mm]
>0 ~ 3	+0.014 ~ +0.054	0 ~ +0.010	0 ~ -0.025
>3 ~ 6	+0.020 ~ +0.068	0 ~ +0.012	0 ~ -0.030
>6 ~ 10	+0.025 ~ +0.083	0 ~ +0.015	0 ~ -0.036
>10 ~ 18	+0.032 ~ +0.102	0 ~ +0.018	0 ~ -0.043
>18 ~ 30	+0.040 ~ +0.124	0 ~ +0.021	0 ~ -0.052
>30 ~ 50	+0.050 ~ +0.150	0 ~ +0.025	0 ~ -0.062
>50 ~ 80	+0.060 ~ +0.180	0 ~ +0.030	0 ~ -0.074
>80 ~ 120	+0.072 ~ +0.212	0 ~ +0.035	0 ~ -0.087
>120 ~ 180	+0.085 ~ +0.245	0 ~ +0.040	0 ~ -0.100

在不同轴材料上旋转时的磨损量 $p=2\text{MPa}$, $v=0.2\text{m/s}$

Wear under rotating with different shaft materials, $p = 2 \text{ MPa}$, $v = 0.2 \text{ m/s}$

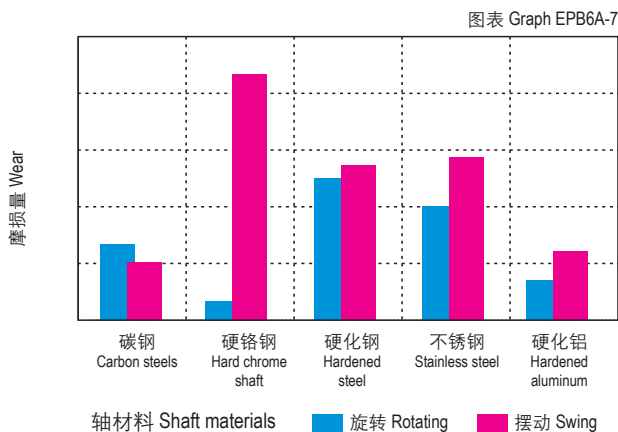

旋转磨损随轴材料与压力变化关系 $v=0.2\text{m/s}$

Wear & pressure under rotating with different shaft materials, $v = 0.2 \text{ m/s}$

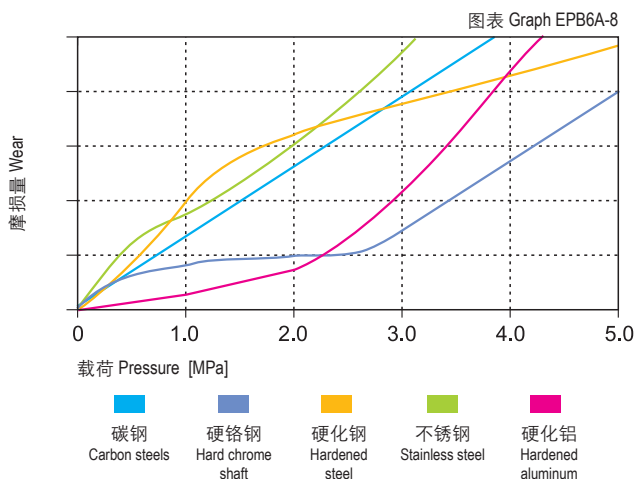

吸水性的影响

Effect of moisture absorption on EPB6A bearings

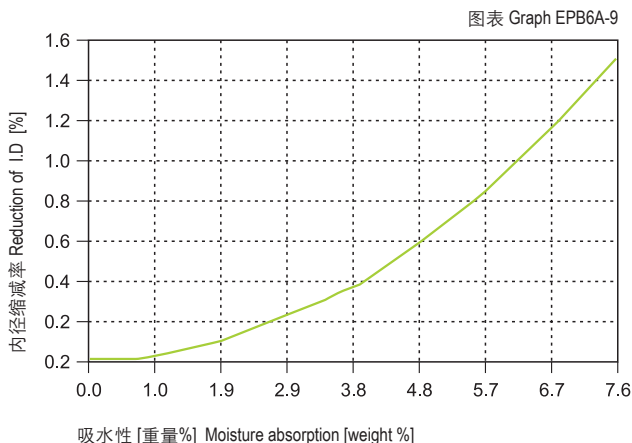



● 标准产品规格表 Standard specifications: P138

产品特性 Product features

- 低摩擦系数和高耐磨性的材料。出色的耐磨性能被应用于CSB其它塑料轴承不能胜任的场合。适合软轴和硬轴材料配合使用
- 连续使用温度: -40°C/+90°C
- 非常耐磨长寿命
- 适合在灰尘中运行
- 对轴表面粗糙度要求低
- 较低的摩擦系数
- 适用于软轴
- A material with low friction factor and good wear resistance. The outstanding wear resistance feature of it ensures the applications where the other plastic bearings are not suitable. It is good for both hard and soft shaft
- Continuous working temperature: -40°C/+90°C
- Good wear resistance with long service life
- Suitable for operation in dusty environment
- No special requirement on the surface roughness
- Low friction coefficient
- Applicable for flexible shaft

材料数据表 Material properties data table

材料性能 Material properties	测试标准 Standard	单位 Unit	CSB-EPB7
颜色 Color	-	-	米黄 Cream
密度 Density	ISO1183	g/cm ³	1.25
最大吸湿率 Max. moisture absorption, 50%RH	ISO62	%	1.3
最大吸水率 Max. water absorption	ISO62	%	6.5
对钢动摩擦系数 Coefficient of sliding friction(steel)	ITS025	μ	0.09-0.20
极限PV值 Max. PV value	ITS026	N/mm ² × m/s	0.50
弯曲模量 Flexural modulus	ISO178	MPa	3200
弯曲强度 Flexural strength	ISO178	MPa	75
最大静载荷 Max. static load	ITS027	MPa	60
最大动载荷 Max. dynamic load	ITS028	MPa	25
邵氏硬度 Shore hardness	ISO868	D	75
连续运行温度 Long-term application temperature	ITS029	°C	+90
短时运行温度 Short-term application temperature	ITS029	°C	+180
最低运行温度 Lowest application temperature	ITS029	°C	-40
导热性 Thermal conductivity	ISO22007	W/m/K	0.24
线性热膨胀系数 Coefficient of thermal expansion	ISO11359	K ⁻¹ × 10 ⁻⁵	9
阻燃等级 Flammability	UL94	Class	HB
体电阻率 Volume resistance	IEC60093	Ω · cm	>10 ¹³
面电阻率 Surface resistance	IEC60093	Ω	>10 ¹²

*ITS: CSB内部测试标准 CSB company's internal test standards.

**除非特殊说明测试温度为23°C Test temperatures are 23°C unless otherwise stated.

轴承PV值 PV value

CSB-EPB7塑料轴承最大运行PV值为0.5N/mm² × m/s; 由此决定轴承所承受的载荷与速度成反比, 详细查阅图表EPB7-1。

The max PV value of the CSB-EPB7 plastic bearings is 0.5N/mm² × m/s which determines the load capacity of bearing is inversely proportional to the speed. Please refer to the chart for more detailed information (Graph EPB7-1).

■ PV图表 Permissible PV value for CSB-EPB7

图表 Graph EPB7-1

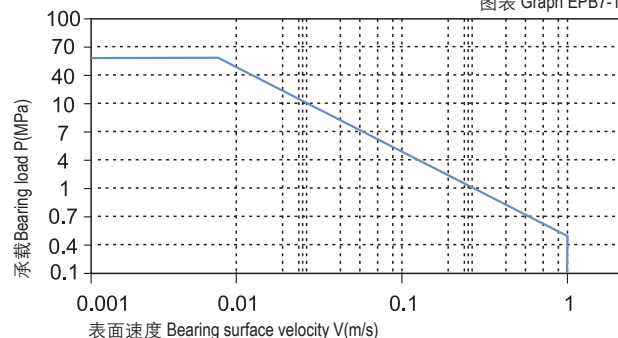

轴承的载荷、速度、温度 Load, speed and temperature

CSB-EPB7塑料轴承可承受最大静载荷为60Mpa，在此载荷下轴承的最大压缩变形量参考图表EPB7-2，轴承实际工作载荷略小于60Mpa，载荷还受到运行速度以及温度的影响，速度越快 (Vmax: 1.0m/s) 会导致摩擦温度上升，而温度上升 (Tmax: 90℃) 会导致轴承的承载能力逐渐减弱，载荷随轴承工作温度变化情况参考图表EPB7-3。

CSB-EPB7 allows the Max static load of 60Mpa, The max compressive deformation rate under the max load is listed in Graph EPB7-2, The actual load capacity of bearing is slightly less than 60Mpa, The bearing load is variable against the speed and temperature, Fast speed (Vmax: 1.0m/s) results into higher temperature (Tmax: 90℃) which decreases the load capacity of the bearing. Please refer to the Graph EPB7-3 for such variation.

轴承的摩擦系数、磨损、轴材料 Friction factor, wear and shaft material

摩擦系数 Friction factor

图表EPB7-4表明CSB-EPB7塑料轴承的摩擦系数随着运动速度的变化影响较小，而图表EPB7-5表明CSB-EPB7塑料轴承的摩擦系数随着载荷的增加明显减小，在载荷超过20Mpa是逐渐趋于平稳；图表EPB7-6表明CSB-EPB7塑料轴承的摩擦系数受轴粗糙度的影响也相对比较小；虽然如此，我们还是建议轴的表面不能太光滑，也不能过于出差，推荐使用轴的粗糙度为Ra0.3 ~ 0.6μm；

CSB-EPB7 Bearing Friction factor is not so sensitive to the operation speed (see Graph EPB7-4). The friction factor is considerably decreased along with the loading increasing and it will be turned to be stable when the loading reaches 20Mpa. Graph EPB7-5 shows the friction factor of the bearing is also not sensitive to the shaft roughness but we still recommend that the roughness of the shaft should be neither too smooth nor too rough. It is recommended to keep the roughness of the shaft to be within the range of Ra0.3 to Ra0.6.

摩擦系数与轴表面粗糙度关系图表

Coefficient of friction & the surface roughness of shaft

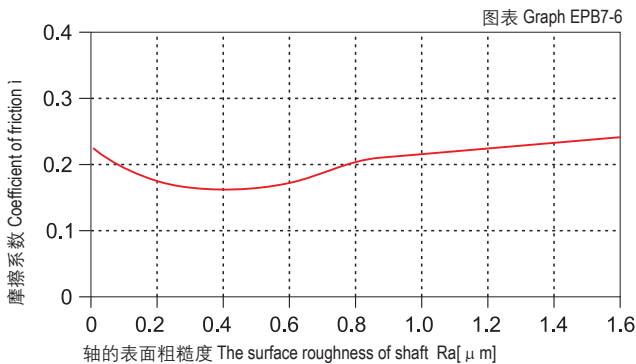

载荷-温度-变形量图表 Load-Temperature deformation

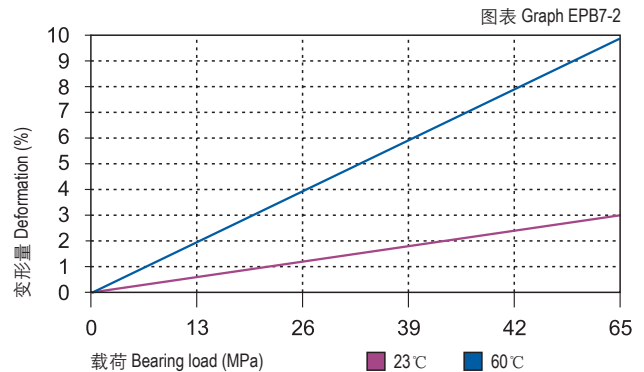

载荷-温度图表 Load-Temperature diagrams

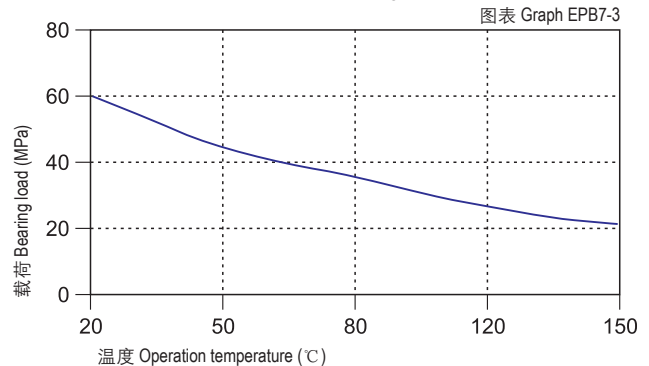

摩擦系数与速度变化关系图表 P=2MPa Coefficient of friction & the speed of bearing, p = 2 MPa

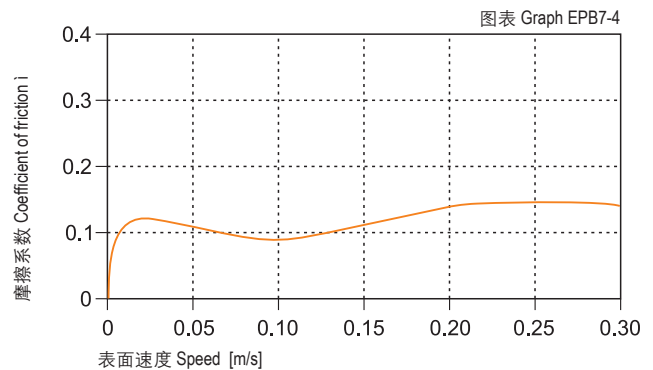

摩擦系数与载荷变化关系图表 v=0.2m/s

Coefficient of friction & the pressure of bearing, v = 0.2 m/s

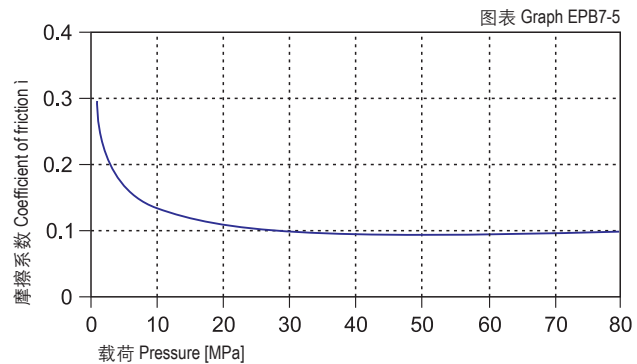

CSB-EPB7	干运行 Dry	油脂 Grease	油 Oil	水 Water
摩擦系数 μ Friction coef.	0.09~0.20	0.09	0.04	0.04

磨损与轴材料 Wearing and shaft material

图表EPB7-7表明CSB-EPB7塑料轴承在2Mpa下做旋转运动时，磨损随着轴材料的变化较大；通过实验表明CSB-EPB7塑料轴承在做旋转运动时比较适合用于硬铬轴，硬化钢轴和硬铬轴上用于CSB-EPB7塑料轴承能获得良好的运行效果。图表EPB7-8表明硬铬轴更适合用于高载荷下的CSB-EPB7塑料轴承，随着载荷的不断增大，轴承的磨损速率却变化较小，图表EPB7-8表明CSB-EPB7塑料轴承在不同载荷下的差异。

Graph EPB7-7 shows that the CSB-EPB7 material is not sensitive with different materials under the rotating operation. It is suitable for hard shaft and high speed steel shaft as well as hard chrome steel shaft. Graph EPB7-8 shows that the hard chrome steel shaft is most suitable for using CSB-EPB7 bearing because the wearing speed is not sensitive when the loading is increased. From the Graph EPB7-8, it shows that CSB-EP7 features different performance.

化学抗性 Chemical resistance

CSB-EPB7塑料轴承能抵抗弱碱以及各类润滑油的腐蚀。CSB-EPB7 is good at chemical resistance against weak acidic medium and various kinds of lubricants.

吸水性 Water absorption

CSB-EPB7塑料轴承在标准大气中的吸湿率为1.3%。浸泡在水中最高吸水率为6.5%。由于高吸水率的特性，我们必须考虑此轴承的应用环境。

The moisture absorption of CSB-EPB7 plastic plain bearings is 1.3% in standard atmosphere. The max. water absorption is 6.5% in water. The application environment has to be considered due to the high water absorption properties.

抗UV性能 UV resistance

CSB-EPB7塑料轴承长久暴露在紫外线下颜色会发生褪变。材料性能基本都不会发生改变。

The color of CSB-EPB7 could be dimmed when it is exposed into the UV ray. The material performance stays stable.

安装公差 Installation tolerances

CSB-EPB7塑料轴承压装后公差 Tolerances after pressfit

直径 Di [mm]	CSB-EPB7 E10 [mm]	座孔 Housing H7 [mm]	轴 Shaft h9 [mm]
>0 ~ 3	+0.014 ~ +0.054	0 ~ +0.010	0 ~ -0.025
>3 ~ 6	+0.020 ~ +0.068	0 ~ +0.012	0 ~ -0.030
>6 ~ 10	+0.025 ~ +0.083	0 ~ +0.015	0 ~ -0.036
>10 ~ 18	+0.032 ~ +0.102	0 ~ +0.018	0 ~ -0.043
>18 ~ 30	+0.040 ~ +0.124	0 ~ +0.021	0 ~ -0.052
>30 ~ 50	+0.050 ~ +0.150	0 ~ +0.025	0 ~ -0.062
>50 ~ 80	+0.060 ~ +0.180	0 ~ +0.030	0 ~ -0.074
>80 ~ 120	+0.072 ~ +0.212	0 ~ +0.035	0 ~ -0.087
>120 ~ 180	+0.085 ~ +0.245	0 ~ +0.040	0 ~ -0.100

在不同轴材料上旋转时的磨损量 $p=2\text{MPa}$, $v=0.2\text{m/s}$
Wear under rotating with different shaft materials, $p = 2 \text{ MPa}$, $v = 0.2 \text{ m/s}$

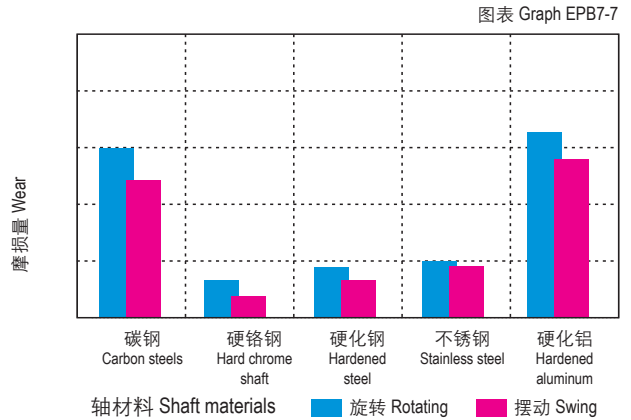

旋转磨损随轴材料与压力变化关系 $v=0.2\text{m/s}$
Wear & pressure under rotating with different shaft materials, $v = 0.2 \text{ m/s}$

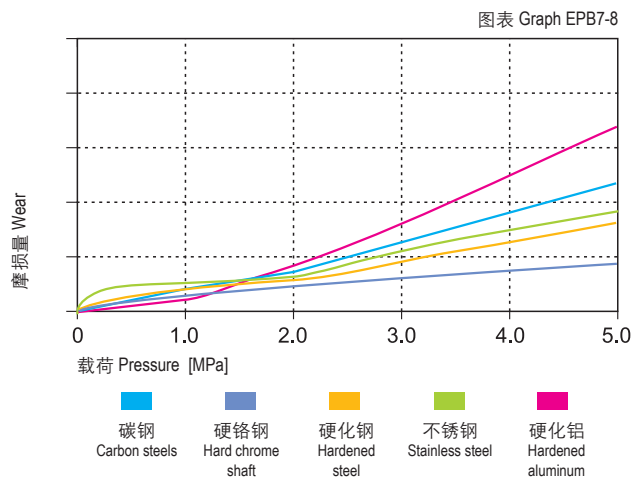

吸水性的影响
Effect of moisture absorption on EPB7 bearings

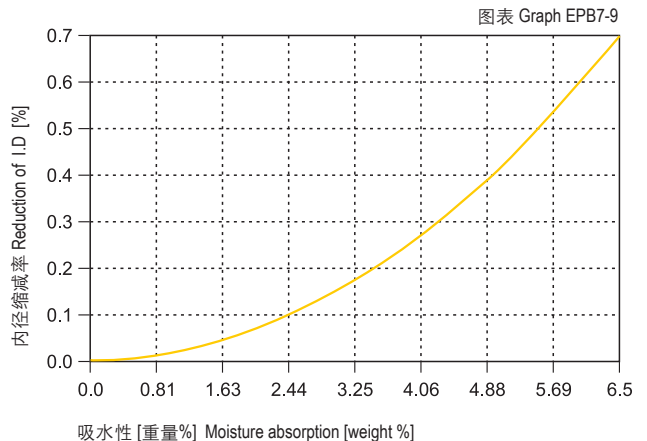



产品特性 Product features

- 一种专门为水下应用而开发的材料。在水下耐磨性尤为出色，可在200度的化学液体中连续运动
- 连续使用温度: -40°C/+200°C
- 重载下耐磨性较好
- 适合水下运行、免维护
- 化学抗性好
- A special material for the application in water. The wear resistance could even be improved in water. It is able to be continuously operated in a chemical liquid with temperature of 200 °C
- Continuous working temperature: -40°C/+200°C
- Good wear resistance under high load
- Suitable for underwater operation
- Good chemical resistance

● 标准产品规格表 Standard specifications: P132

材料数据表 Material properties data table

材料性能 Material properties	测试标准 Standard	单位 Unit	CSB-EPB8
颜色 Color	-	-	深灰 Dark grey
密度 Density	ISO1183	g/cm ³	1.55
最大吸湿率 Max. moisture absorption, 50%RH	ISO62	%	0.1
最大吸水率 Max. water absorption	ISO62	%	0.1
对钢动摩擦系数 Coefficient of sliding friction(steel)	ITS025	μ	0.07-0.18
极限PV值 Max. PV value	ITS026	N/mm ² × m/s	0.80
弯曲模量 Flexural modulus	ISO178	MPa	8000
弯曲强度 Flexural strength	ISO178	MPa	150
最大静载荷 Max. static load	ITS027	MPa	85
最大动载荷 Max. dynamic load	ITS028	MPa	47
邵氏硬度 Shore hardness	ISO868	D	82
连续运行温度 Long-term application temperature	ITS029	°C	+200
短时运行温度 Short-term application temperature	ITS029	°C	+240
最低运行温度 Lowest application temperature	ITS029	°C	-40
导热性 Thermal conductivity	ISO22007	W/m/K	0.50
线性热膨胀系数 Coefficient of thermal expansion	ISO11359	K ⁻¹ × 10 ⁻⁵	5
阻燃等级 Flammability	UL94	Class	V0
体电阻率 Volume resistance	IEC60093	Ω · cm	>10 ⁵
面电阻率 Surface resistance	IEC60093	Ω	>10 ⁵

*ITS: CSB内部测试标准 CSB company's internal test standards.

**除非特殊说明测试温度为23°C Test temperatures are 23°C unless otherwise stated.

轴承PV值 PV value

CSB-EPB8塑料轴承最大运行PV值为0.8N/mm² × m/s; 由此决定轴承所承受的载荷与速度成反比, 详细查阅图表EPB8-1。

The max PV value of the CSB-EPB8 plastic bearings is 0.8N/mm² × m/s which determines the load capacity of bearing is inversely proportional to the speed. Please refer to the chart for more detailed information (Graph EPB8-1).

■ PV图表 Permissible PV value for CSB-EPB8

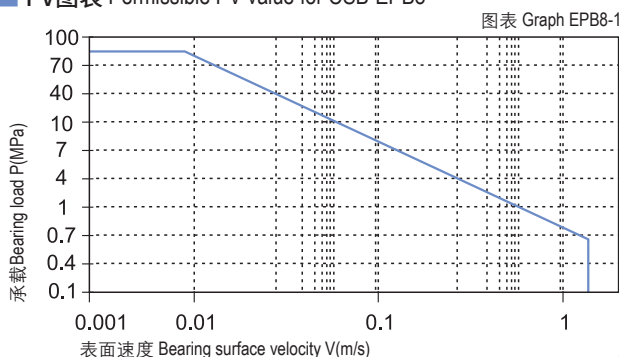

轴承的载荷、速度、温度 Load, speed and temperature

CSB-EPB8塑料轴承可承受最大静载荷为85Mpa，在此载荷下轴承的最大压缩变形量参考图表EPB8-2，轴承实际工作载荷略小于85Mpa，载荷还受到运行速度以及温度的影响，速度越快 (Vmax: 1.2m/s) 会导致摩擦温度上升，而温度上升 (Tmax: 200℃) 会导致轴承的承载能力逐渐减弱，载荷随轴承工作温度变化情况参考图表EPB8-3。

CSB-EPB8 allows the Max static load of 85Mpa, The max compressive deformation rate under the max load is listed in Graph EPB8-2, The actual load capacity of bearing is slightly less than 85Mpa, The bearing load is variable against the speed and temperature, Fast speed (Vmax: 1.2m/s) results into higher temperature (Tmax: 200℃) which decreases the load capacity of the bearing. Please refer to the Graph EPB8-3 for such variation.

轴承的摩擦系数、磨损、轴材料 Friction factor, wear and shaft material

摩擦系数 Friction factor

图表EPB8-4表明CSB-EPB8塑料轴承的摩擦系数在载荷保持不变时随着运行速度的增加影响较小；专用润滑剂的植入使得此轴承更适合用于水下。图表EPB8-5表明CSB-EPB8塑料轴承在速度保持不变的情况下载荷超过20Mpa摩擦系数随着载荷的变化相对较小。图表EPB8-6表明轴表面粗糙度对CSB-EPB8塑料轴承的摩擦系数影响较大，在轴表面粗糙度超过Ra0.7时趋于平稳。我们推荐使用轴的表面粗糙度为Ra0.2 ~ 0.3um。

Graph EPB8-4 shows that the friction factor of CSB-EPB8 is not considerably affected by the operation speed when the loading is stable. The special embedded lubricant helps the material to be suitable for the underwater operation. When the operation speed keeps stable and the loading is over 20Mpa, the friction factor of CSB-EPB8 is not variable along with the loading change (See Graph EPB8-5). The shaft roughness highly affects the friction factor but this affecting will be stable when the shaft roughness is better than Ra0.7 (See Graph EPB8-6). The recommended shaft roughness is Ra0.2 to Ra0.3.

摩擦系数与轴表面粗糙度关系图表

Coefficient of friction & the surface roughness of shaft

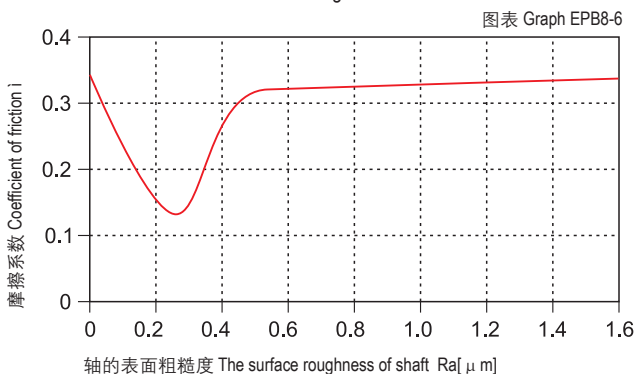

载荷-温度-变形量图表 Load-Temperature deformation

图表 Graph EPB8-2

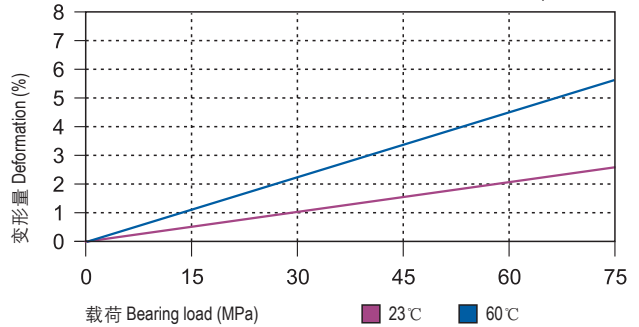

载荷-温度图表 Load-Temperature diagrams

图表 Graph EPB8-3

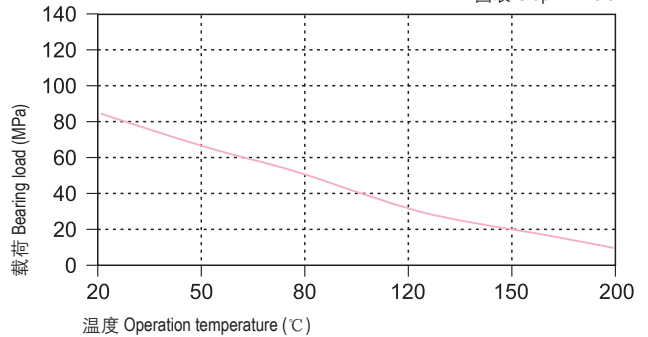

摩擦系数与速度变化关系图表 P=2MPa

Coefficient of friction & the speed of bearing, p = 2 MPa

图表 Graph EPB8-4

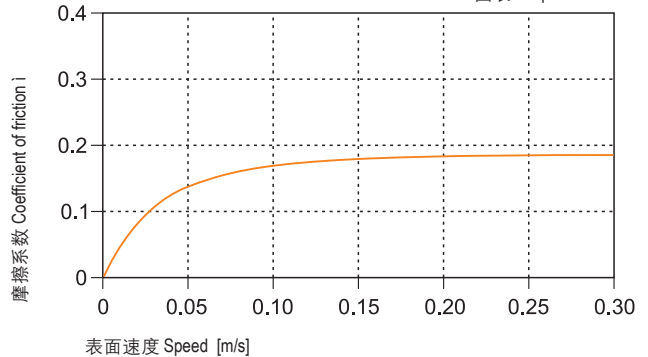

摩擦系数与载荷变化关系图表 v=0.2m/s

Coefficient of friction & the pressure of bearing, v = 0.2 m/s

图表 Graph EPB8-5

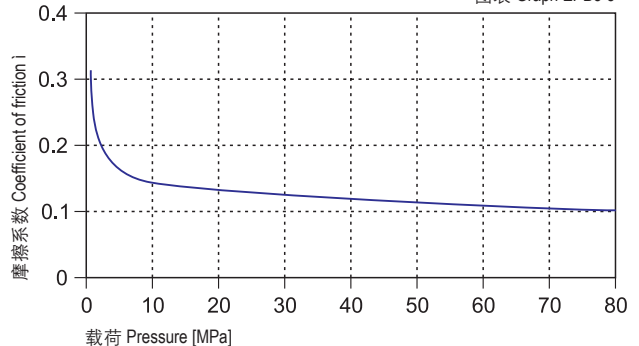

CSB-EPB8	干运行 Dry	油脂 Grease	油 Oil	水 Water
摩擦系数 μ Friction coef.	0.07~0.18	0.09	0.04	0.04

磨损与轴材料 Wearing and shaft material

图表EPB8-7与图表EPB8-8对CSB-EPB8塑料轴承在不同轴材料旋转运动下的测试结果表明，CSB-EPB8塑料轴承最理想的轴材料是硬铬钢轴，而不锈钢轴不适合用于此轴承。CSB-EPB8塑料轴承在摆动运动中采用不锈钢轴或硬铬钢轴比较适合，而在旋转运动中硬铬钢轴依然是更佳的选择。

The rotation test against different shaft material showing in Graph EPB8-7 and Graph EPB8-8 induces that the best mating shaft material for the material CSB-EPB8 is hardened chrome steel shaft but not stainless steel shaft. CSB-EPB8 is best for stainless steel and hardened chrome steel shaft in oscillation operation and especially the hardened chrome steel shaft is the best choice in rotation operation.

化学抗性 Chemical resistance

CSB-EPB8塑料轴承具有很好的化学抗性，能抵抗绝大多数酸碱。

The Chemical Resistance of CSB-EPB8 is fairly good against most of Acid and Alkalis.

吸水性 Water absorption

CSB-EPB8塑料轴承在标准大气中的吸湿率为0.1%。浸泡在水中的最高吸水率为0.1%。极低吸水率不会导致轴承发生性能和尺寸变化，非常适合用于水下。

The moisture absorption of CSB-EPB8 plastic plain bearings is 0.1% in standard atmosphere. The max. water absorption is 0.1% in water. These values are very low, CSB-EPB8 plastic plain bearings is very well suited for used in water.

抗UV性能 UV resistance

CSB-EPB8塑料轴承长久暴露在紫外线下材料表面会发生蜕变，抗压强度会下降。

Disintegration could be possible for the material CSB-EPB8 after long period of exposing under the UV ray and therefore the compressive strength will be reduced.

安装公差 Installation tolerances

CSB-EPB8塑料轴承压装后公差 Tolerances after pressfit

直径 Di [mm]	CSB-EPB8 F10 [mm]	座孔 Housing H7 [mm]	轴 Shaft h9 [mm]
>0 ~ 3	+0.006 ~ +0.046	0 ~ +0.010	0 ~ -0.025
>3 ~ 6	+0.010 ~ +0.058	0 ~ +0.012	0 ~ -0.030
>6 ~ 10	+0.013 ~ +0.071	0 ~ +0.015	0 ~ -0.036
>10 ~ 18	+0.016 ~ +0.086	0 ~ +0.018	0 ~ -0.043
>18 ~ 30	+0.020 ~ +0.104	0 ~ +0.021	0 ~ -0.052
>30 ~ 50	+0.025 ~ +0.125	0 ~ +0.025	0 ~ -0.062
>50 ~ 80	+0.030 ~ +0.150	0 ~ +0.030	0 ~ -0.074
>80 ~ 120	+0.036 ~ +0.176	0 ~ +0.035	0 ~ -0.087
>120 ~ 180	+0.043 ~ +0.203	0 ~ +0.040	0 ~ -0.100

在不同轴材料上旋转时的磨损量 $p=2\text{MPa}$, $v=0.2\text{m/s}$ Wear under rotating with different shaft materials, $p = 2 \text{ MPa}$, $v = 0.2 \text{ m/s}$

图表 Graph EPB8-7

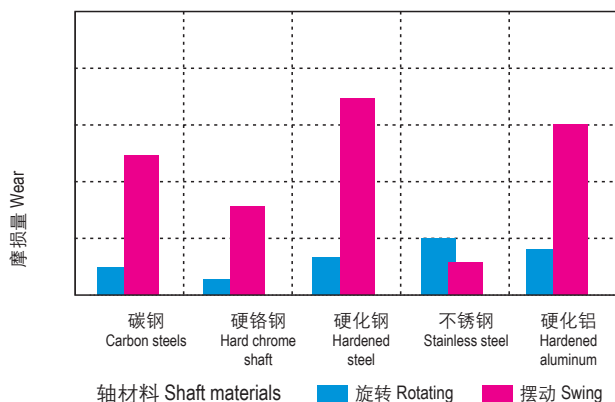

旋转磨损随轴材料与压力变化关系 $v=0.2\text{m/s}$ Wear & pressure under rotating with different shaft materials, $v = 0.2 \text{ m/s}$

图表 Graph EPB8-8

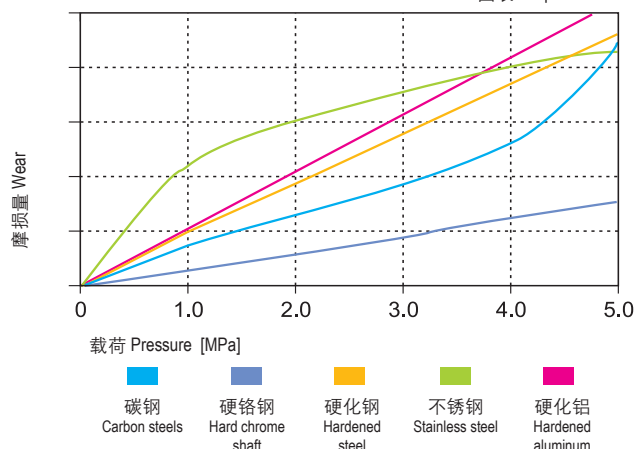

吸水性的影响 Effect of moisture absorption on EPB8 bearings

图表 Graph EPB8-9

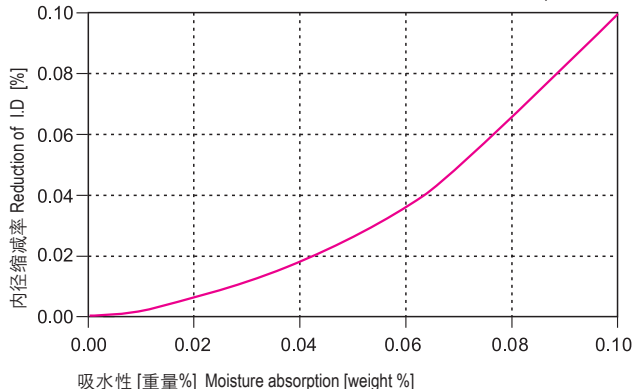



产品特性 Product features

- 导电性优良的自润滑材料。主要因用于高载荷下导电性需求
- 连续使用温度: -40°C/+140°C
- 专用于要求抗静电场合
- 适合低速运动
- 较高的承载能力
- Self-lubricated material with good electricity conductivity. Mainly used with the high load and electricity conductive environment
- Continuous working temperature: -40°C/+140°C
- Specially use for static electricity existing environment
- Suitable for low speed operation
- Higher load capacity

● 标准产品规格表 Standard specifications: P128

材料数据表 Material properties data table

材料性能 Material properties	测试标准 Standard	单位 Unit	CSB-EPB9
颜色 Color	-	-	黑色 Black
密度 Density	ISO1183	g/cm ³	1.28
最大吸湿率 Max. moisture absorption, 50%RH	ISO62	%	1.3
最大吸水率 Max. water absorption	ISO62	%	6.5
对钢动摩擦系数 Coefficient of sliding friction(steel)	ITS025	μ	0.10-0.40
极限PV值 Max. PV value	ITS026	N/mm ² × m/s	0.35
弯曲模量 Flexural modulus	ISO178	MPa	10000
弯曲强度 Flexural strength	ISO178	MPa	250
最大静载荷 Max. static load	ITS027	MPa	105
最大动载荷 Max. dynamic load	ITS028	MPa	58
邵氏硬度 Shore hardness	ISO868	D	82
连续运行温度 Long-term application temperature	ITS029	°C	+140
短时运行温度 Short-term application temperature	ITS029	°C	+180
最低运行温度 Lowest application temperature	ITS029	°C	-40
导热性 Thermal conductivity	ISO22007	W/m/K	0.60
线性热膨胀系数 Coefficient of thermal expansion	ISO11359	K ⁻¹ × 10 ⁻⁵	11
阻燃等级 Flammability	UL94	Class	HB
体电阻率 Volume resistance	IEC60093	Ω · cm	<10 ³
面电阻率 Surface resistance	IEC60093	Ω	<10 ³

*ITS: CSB内部测试标准 CSB company's internal test standards.

**除非特殊说明测试温度为23°C Test temperatures are 23°C unless otherwise stated.

轴承PV值 PV value

CSB-EPB9塑料轴承最大运行PV值为0.35N/mm² × m/s; 由此决定轴承所承受的载荷与速度成反比, 详细查阅图表EPB9-1。

The max PV value of the CSB-EPB9 plastic bearings is 0.35N/mm² × m/s which determines the load capacity of bearing is inversely proportional to the speed. Please refer to the chart for more detailed information (Graph EPB9-1).

■ PV图表 Permissible PV value for CSB-EPB9

图表 Graph EPB9-1

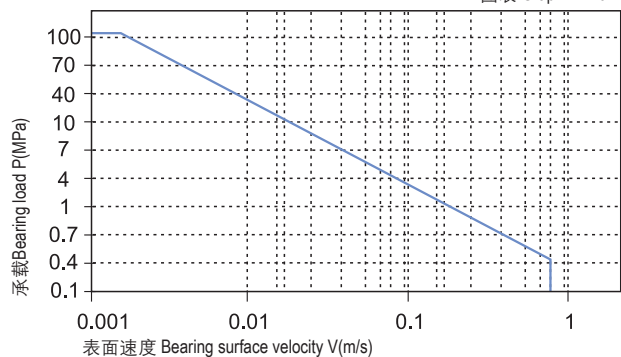

轴承的载荷、速度、温度 Load, speed and temperature

CSB-EPB9塑料轴承可承受最大静载荷为105Mpa，在此载荷下轴承的最大压缩变形量参考图表EPB9-2，轴承实际工作载荷略小于105Mpa，载荷还受到运行速度以及温度的影响，速度越快 (Vmax: 0.8m/s) 会导致摩擦温度上升，而温度上升 (Tmax: 140℃) 会导致轴承的承载能力逐渐减弱，载荷随轴承工作温度变化情况参考图表EPB9-3。

CSB-EPB9 allows the Max static load of 105Mpa, The max compressive deformation rate under the max load is listed in Graph EPB9-2, The actual load capacity of bearing is slightly less than 105Mpa, The bearing load is variable against the speed and temperature, Fast speed (Vmax: 0.8m/s) results into higher temperature (Tmax: 140℃) which decreases the load capacity of the bearing. Please refer to the Graph EPB9-3 for such variation.

轴承的摩擦系数、磨损、轴材料 Friction factor, wear and shaft material

摩擦系数 Friction factor

图表EPB9-4表明CSB-EPB9塑料轴承的摩擦系数相对其它塑料轴承较高，这主要是由于此轴承材料内部植入了导电纤维的原因；这就决定了此轴承在有润滑的情况下摩擦系数更好。图表EPB9-5表明CSB-EPB9塑料轴承的摩擦系数同样会随着载荷的增加而逐步降低；图表EPB9-6表明CSB-EPB9塑料轴承的摩擦系数在轴粗糙度为Ra0.1 ~ 0.5之间时随着轴粗糙度的增大而逐步减低，而当轴表面粗糙度在Ra0.5 ~ 1.6之间时却影响较小。

Graph EPB9-4 shows that the friction factor of CSB-EPB9 is much higher than those of other materials because the electronic conductive fiber is embedded into the bearing material. It is induced that the friction performance will be better when the bearing is lubricated. Graph EPB9-5 shows that the friction factory is decreasing along with the loading increasing and Graph EPB9-6 shows that the friction factor is increasing along with the shaft roughness increasing when the shaft roughness is between Ra0.1 to Ra0.5. This effecting will be less when the shaft roughness is between Ra0.5 to Ra1.6.

摩擦系数与轴表面粗糙度关系图表

Coefficient of friction & the surface roughness of shaft

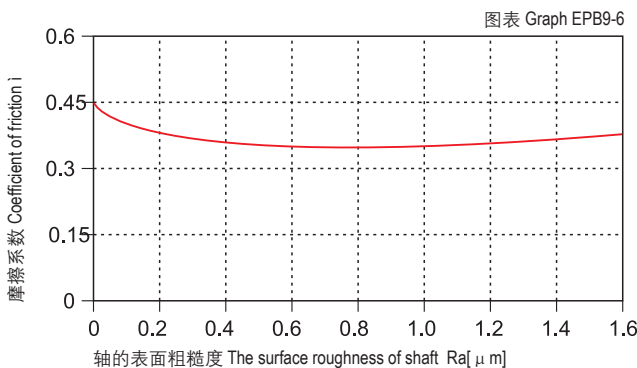

载荷-温度-变形量图表 Load-Temperature deformation

图表 Graph EPB9-2

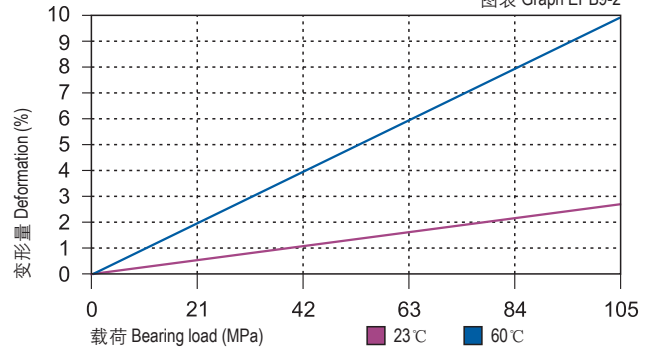

载荷-温度图表 Load-Temperature diagrams

图表 Graph EPB9-3

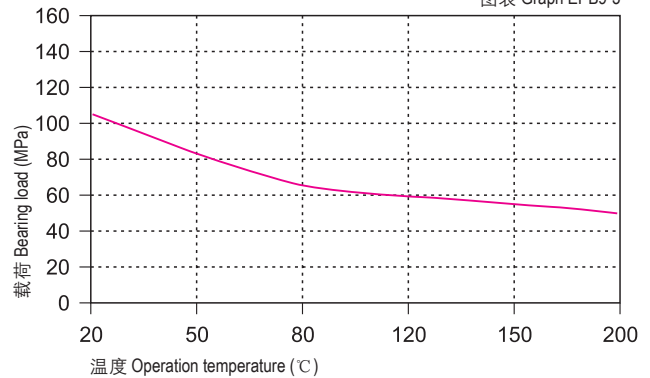

摩擦系数与速度变化关系图表 P=2MPa

Coefficient of friction & the speed of bearing, p = 2 MPa

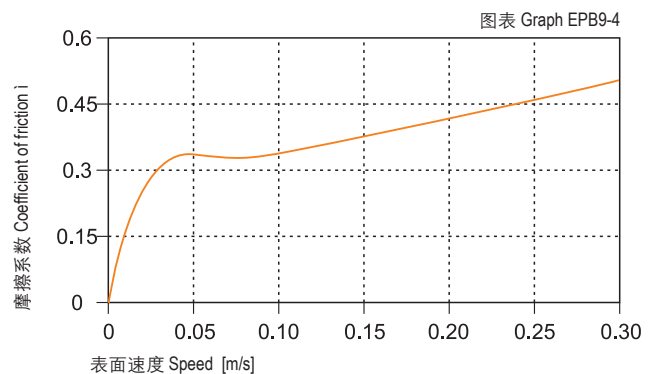

摩擦系数与载荷变化关系图表 v=0.2m/s

Coefficient of friction & the pressure of bearing, v = 0.2 m/s

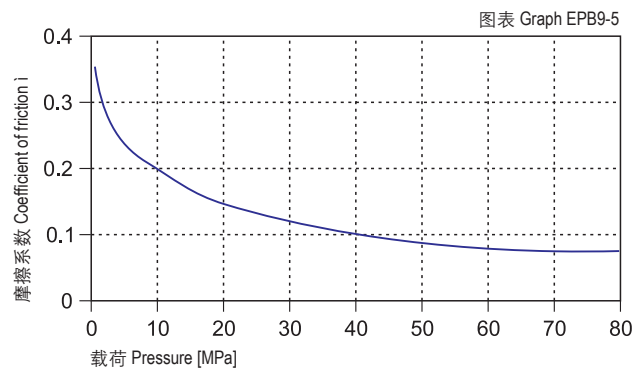

CSB-EPB9	干运行 Dry	油脂 Grease	油 Oil	水 Water
摩擦系数 μ Friction coef.	0.10~0.40	0.09	0.04	0.04

磨损与轴材料 Wearing and shaft material

图表EPB9-7与图表EPB9-8表明了CSB-EPB9塑料轴承在不同轴材料上旋转运动磨损情况。由此可以看出在低载荷旋转运动时，硬铬钢轴比较适合，而在高载旋转运动时，硬化钢轴比较适合。

Graph EPB9-7 and EPB9-8 shows the different results of the material against different shaft materials. It induces that the bearing material is good for hard chrome steel shaft under low loading operation condition and good for hardened carbon steel shaft under high loading rotation operation.

化学抗性 Chemical resistance

CSB-EPB9塑料轴承能抵抗弱碱以及各类润滑油的腐蚀。CSB-EPB9 is good at chemical resistance against weak acidic medium and various kinds of lubricants.

吸水性 Water absorption

CSB-EPB9塑料轴承在标准大气中的吸湿率为1.3%。浸泡在水中最高吸水率为6.5%。由于高吸水率的特性，我们必须考虑此轴承的应用环境。

The moisture absorption of CSB-EPB9 plastic plain bearings is 1.3% in standard atmosphere. The max. water absorption is 6.5% in water. The application environment has to be considered due to the high water absorption properties.

抗UV性能 UV resistance

CSB-EPB9塑料轴承长久暴露在紫外线下材料性能基本都不会发生改变。

When CSB-EPB9 is exposed into the UV ray, the material performance stays stable.

安装公差 Installation tolerances

CSB-EPB9塑料轴承压装后公差 Tolerances after pressfit

直径 Di. [mm]	CSB-EPB9 E10 [mm]	座孔 Housing H7 [mm]	轴 Shaft h9 [mm]
>0 ~ 3	+0.014 ~ +0.054	0 ~ +0.010	0 ~ -0.025
>3 ~ 6	+0.020 ~ +0.068	0 ~ +0.012	0 ~ -0.030
>6 ~ 10	+0.025 ~ +0.083	0 ~ +0.015	0 ~ -0.036
>10 ~ 18	+0.032 ~ +0.102	0 ~ +0.018	0 ~ -0.043
>18 ~ 30	+0.040 ~ +0.124	0 ~ +0.021	0 ~ -0.052
>30 ~ 50	+0.050 ~ +0.150	0 ~ +0.025	0 ~ -0.062
>50 ~ 80	+0.060 ~ +0.180	0 ~ +0.030	0 ~ -0.074
>80 ~ 120	+0.072 ~ +0.212	0 ~ +0.035	0 ~ -0.087
>120 ~ 180	+0.085 ~ +0.245	0 ~ +0.040	0 ~ -0.100

在不同轴材料上旋转时的磨损量 $p=2\text{MPa}$, $v=0.2\text{m/s}$

Wear under rotating with different shaft materials, $p = 2 \text{ MPa}$, $v = 0.2 \text{ m/s}$

图表 Graph EPB9-7

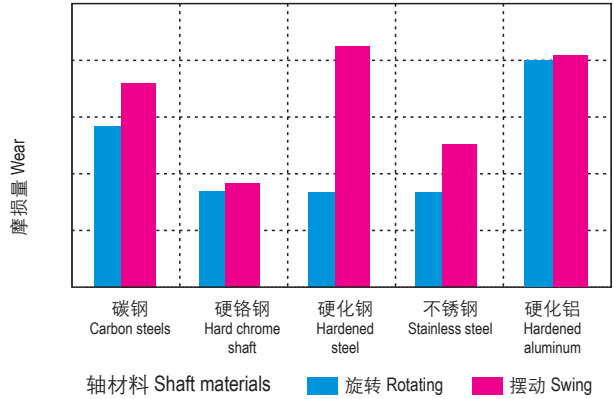

旋转磨损随轴材料与压力变化关系 $v=0.2\text{m/s}$

Wear & pressure under rotating with different shaft materials, $v = 0.2 \text{ m/s}$

图表 Graph EPB9-8

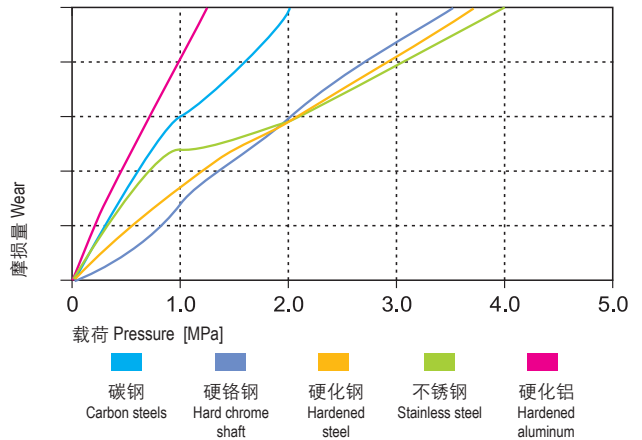

吸水性的影响

Effect of moisture absorption on EPB9 bearings

图表 Graph EPB9-9

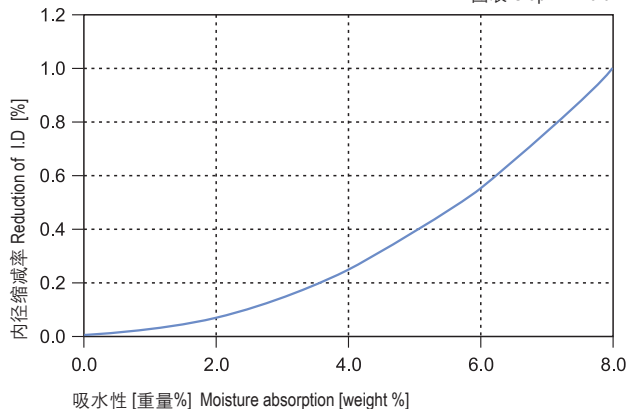



● 标准产品规格表 Standard specifications: P132

产品特性 Product features

- 高温250度、高化学抗性和高载荷的良好结合。同样适用于水下或大部分化学液体下做高速运动
- 连续使用温度: -100℃/+250℃
- 非常耐磨长寿命
- 适合在灰尘中运行
- 对轴表面粗糙度要求低
- 较低的摩擦系数
- It is a material with good high temperature upto 250 °C, high chemical resistance and high load application. It is suitable for the applications in water or most of chemical liquids.
- Continuous working temperature: -100 °C/+250 °C
- Good wear resistance with long service life
- Suitable for operation in dusty environment
- No special requirement on the surface roughness
- Low friction coefficient

材料数据表 Material properties data table

材料性能 Material properties	测试标准 Standard	单位 Unit	CSB-EPB10
颜色 Color	-	-	黑色 Black
密度 Density	ISO1183	g/cm ³	1.42
最大吸湿率 Max. moisture absorption, 50%RH	ISO62	%	0.1
最大吸水率 Max. water absorption	ISO62	%	0.5
对钢动摩擦系数 Coefficient of sliding friction(steel)	ITS025	μ	0.10-0.25
极限PV值 Max. PV value	ITS026	N/mm ² × m/s	1.35
弯曲模量 Flexural modulus	ISO178	MPa	10000
弯曲强度 Flexural strength	ISO178	MPa	210
最大静载荷 Max. static load	ITS027	MPa	125
最大动载荷 Max. dynamic load	ITS028	MPa	80
邵氏硬度 Shore hardness	ISO868	D	86
连续运行温度 Long-term application temperature	ITS029	°C	+250
短时运行温度 Short-term application temperature	ITS029	°C	+315
最低运行温度 Lowest application temperature	ITS029	°C	-100
导热性 Thermal conductivity	ISO22007	W/m/K	0.60
线性热膨胀系数 Coefficient of thermal expansion	ISO11359	K ⁻¹ × 10 ⁻⁵	5
阻燃等级 Flammability	UL94	Class	V0
体电阻率 Volume resistance	IEC60093	Ω · cm	>10 ⁵
面电阻率 Surface resistance	IEC60093	Ω	>10 ⁵

*ITS: CSB内部测试标准 CSB company's internal test standards.

**除非特殊说明测试温度为23℃ Test temperatures are 23 °C unless otherwise stated.

轴承PV值 PV value

CSB-EPB10塑料轴承最大运行PV值为1.35N/mm² × m/s; 由此决定轴承所承受的载荷与速度成反比, 详细查阅图表EPB10-1。

The max PV value of the CSB-EPB10 plastic bearings is 1.35N/mm² × m/s which determines the load capacity of bearing is inversely proportional to the speed. Please refer to the chart for more detailed information (Graph EPB10-1).

■ PV图表 Permissible PV value for CSB-EPB10

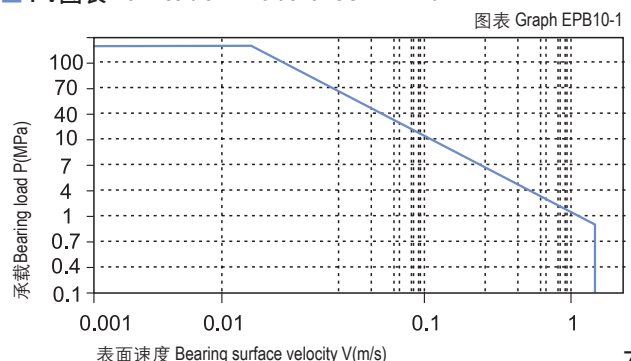

轴承的载荷、速度、温度 Load, speed and temperature

CSB-EPB10塑料轴承可承受最大静载荷为125Mpa, 在此载荷下轴承的最大压缩变形量参考图表EPB10-2, 轴承实际工作载荷略小于125Mpa, 载荷还受到运行速度以及温度的影响, 速度越快 (Vmax: 1.5m/s) 会导致摩擦温度上升, 而温度上升 (Tmax: 250℃) 会导致轴承的承载能力逐渐减弱, 载荷随轴承工作温度变化情况参考图表EPB10-3。

CSB-EPB10 allows the Max static load of 125Mpa, The max compressive deformation rate under the max load is listed in Graph EPB10-2, The actual load capacity of bearing is slightly less than 125Mpa, The bearing load is variable against the speed and temperature, Fast speed (Vmax: 1.5m/s) results into higher temperature (Tmax: 250℃) which decreases the load capacity of the bearing. Please refer to the Graph EPB10-3 for such variation.

轴承的摩擦系数、磨损、轴材料 Friction factor, wear and shaft material

摩擦系数 Friction factor

图表EPB10-4表明CSB-EPB10塑料轴承的摩擦系数数在载荷一定时随着运行速度的增加而逐渐升高; 图表EPB10-5表明CSB-EPB10塑料轴承在速度一定载荷在30Mpa以内时摩擦系数会随着载荷的逐步增加而快速降低, 而当载荷高于30Mpa时摩擦系数的变化却比较平缓。图表EPB10-6表明CSB-EPB10塑料轴承比较适合轴表面粗糙度为Ra0.6~0.8um。

Graph EPB10-4 shows that the friction factor of CSB-EPB10 is increasing along with the operation speed when the loading is stable within 30 Mpa. When the loading is higher than 30Mpa, the friction factor variation will not be detectable. Graph EPB10-6 describes that CSB-EPB10 is featured best within the shaft surface roughness of Ra0.6~0.8.

■ 载荷-温度-变形量图表 Load-Temperature deformation

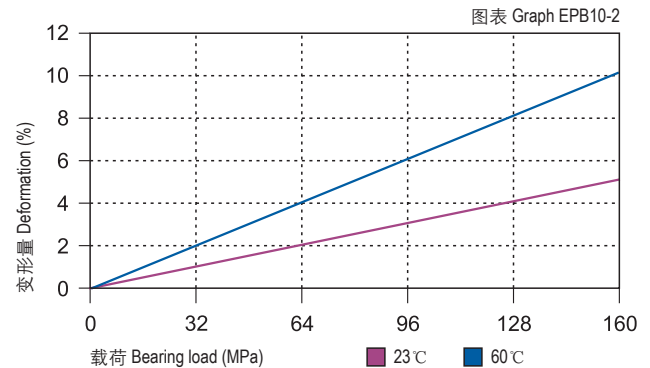

■ 载荷-温度图表 Load-Temperature diagrams

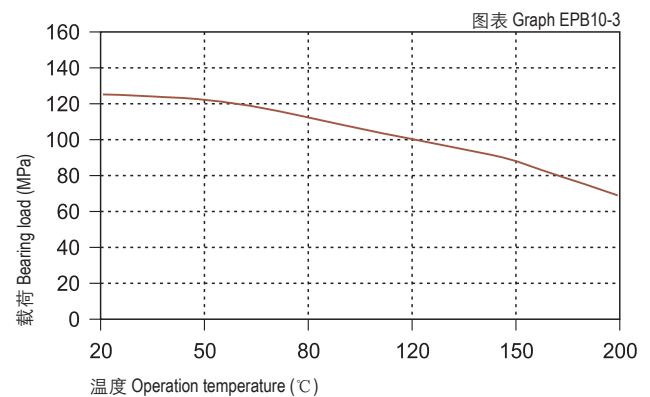

■ 摩擦系数与速度变化关系图表 P=2MPa Coefficient of friction & the speed of bearing, p = 2 MPa

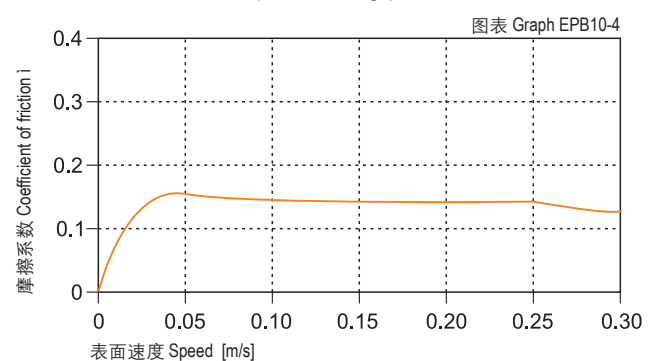

■ 摩擦系数与载荷变化关系图表 v=0.2m/s Coefficient of friction & the pressure of bearing, v = 0.2 m/s

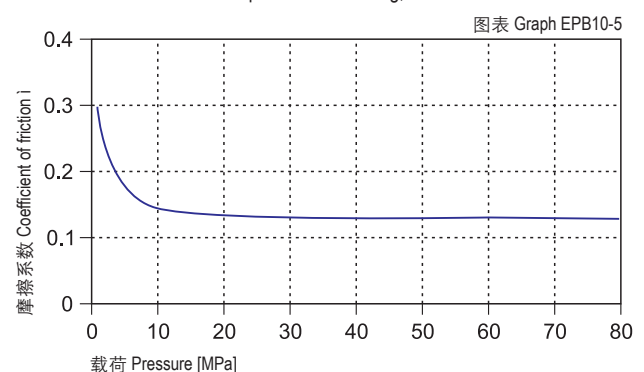

■ 摩擦系数与轴表面粗糙度关系图表 Coefficient of friction & the surface roughness of shaft

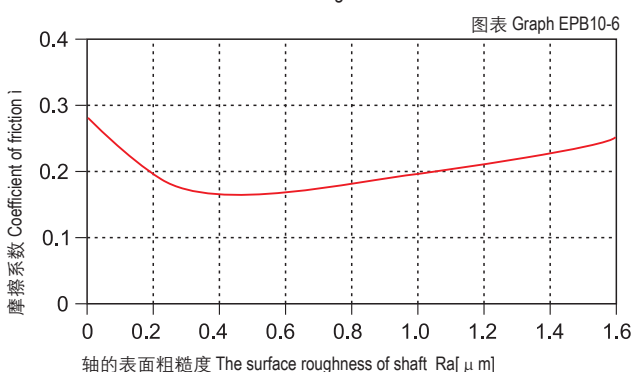

CSB-EPB10	干运行 Dry	油脂 Grease	油 Oil	水 Water
摩擦系数 μ Friction coef.	0.10~0.25	0.09	0.04	0.04

磨损与轴材料 Wearing and shaft material

图表EPB10-7和图表EPB10-8测试表明了CSB-EPB10塑料轴承在不同轴材料上的运行磨损对比, 在载荷2Mpa以下旋转运动时不锈钢轴和碳钢轴比较适合, 而当载荷超过2Mpa时在硬化钢轴和硬铬轴上的运行效果较好。图表EPB10-7表明CSB-EPB10塑料轴承比较适合用于旋转运动; 特别值得注意的是图表EPB10-9表明CSB-EPB10轴承在常温23℃下的摩擦磨损性能并没有在高温150℃下优秀。

Graph EPB10-7 and Graph EPB10-8 is the comparing test for the CSB-EPB10 wearing against different shaft materials. Stainless steel and hot-rolled steel shaft is the best shaft material for CSB-EPB10 when the loading is lower than 2Mpa. Graph EPB10-7 shows that CSB-EPB10 is most suitable for rotation operation. Graph EPB10-9 shows a very special feature of CSB-EPB10 that the wearing Features of CSB-EPB10 is much better when the temperature is 150℃ than that of the temperature of 23℃.

化学抗性 Chemical Resistance

CSB-EPB10塑料轴承具有极好的化学抗性, 能抵抗浓度65%的强酸。
Chemical Resistance of CSB-EPB10 is very good. It can work well in the heavy acid of 65%.

吸水性 Water absorption

CSB-EPB10塑料轴承在标准大气中的吸湿率为0.1%。浸泡在水中的最高吸水率为0.5%。极低吸水率不会导致轴承发生性能和尺寸变化, 非常适合用于潮湿环境。

The moisture absorption of CSB-EPB10 plastic plain bearings is 0.1% in standard atmosphere. The max. water absorption is 0.5% in water. These values are very low, CSB-EPB10 plastic plain bearings is very well suited for used in wet applications.

抗UV性能 UV resistance

CSB-EPB10塑料轴承长久暴露在紫外线下材料性能不会发生变化。

CSB-EPB10 can maintain its performance to be stable even exposed in the UV ray for long period.

安装公差 Installation tolerances

CSB-EPB10 塑料轴承压装后公差 Tolerances after pressfit

直径 Di. [mm]	CSB-EPB10 F10 [mm]	座孔 Housing H7 [mm]	轴 Shaft h9 [mm]
>0 ~ 3	+0.006 ~ +0.046	0 ~ +0.010	0 ~ -0.025
>3 ~ 6	+0.010 ~ +0.058	0 ~ +0.012	0 ~ -0.030
>6 ~ 10	+0.013 ~ +0.071	0 ~ +0.015	0 ~ -0.036
>10 ~ 18	+0.016 ~ +0.086	0 ~ +0.018	0 ~ -0.043
>18 ~ 30	+0.020 ~ +0.104	0 ~ +0.021	0 ~ -0.052
>30 ~ 50	+0.025 ~ +0.125	0 ~ +0.025	0 ~ -0.062
>50 ~ 80	+0.030 ~ +0.150	0 ~ +0.030	0 ~ -0.074
>80 ~ 120	+0.036 ~ +0.176	0 ~ +0.035	0 ~ -0.087

● 标准产品规格表 Standard specifications: P132

在不同轴材料上旋转时的磨损量 $p=2\text{MPa}, v=0.2\text{m/s}$ Wear under rotating with different shaft materials, $p = 2 \text{ MPa}, v = 0.2 \text{ m/s}$

图表 Graph EPB10-7

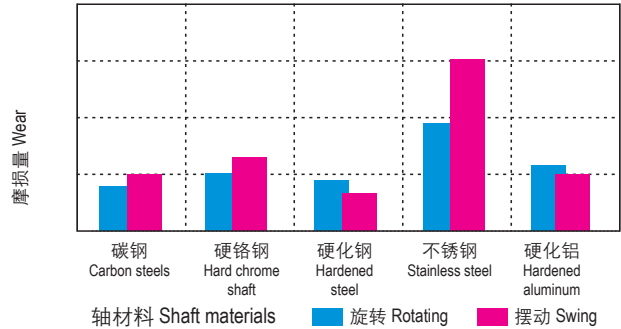

旋转磨损随轴材料与压力变化关系 $v=0.2\text{m/s}$ Wear & pressure under rotating with different shaft materials, $v = 0.2 \text{ m/s}$

图表 Graph EPB10-8

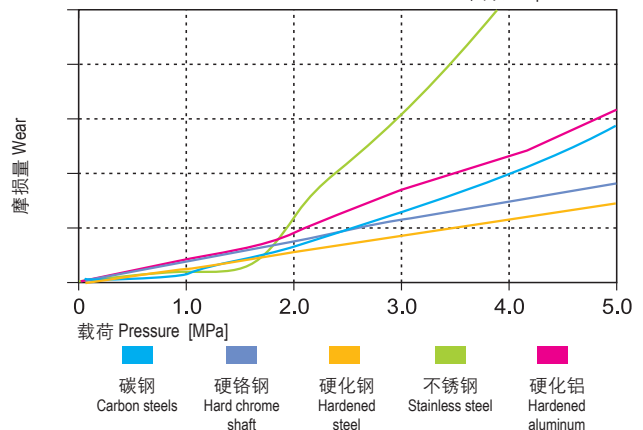

在不同温度下的磨损量 $p=2\text{MPa}, v=0.2\text{m/s}$ The bearing wear under rotating with different temperature $p=2\text{MPa}, v=0.2\text{m/s}$

图表 Graph EPB10-9

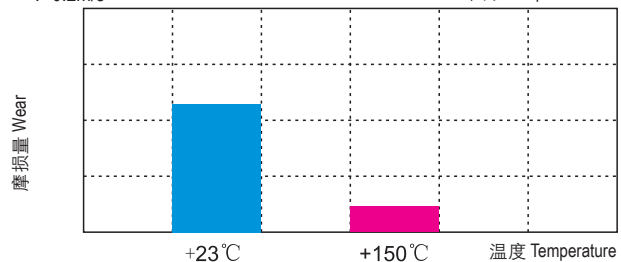

吸水性的影响 Effect of moisture absorption on EPB10 bearings

图表 Graph EPB10-10

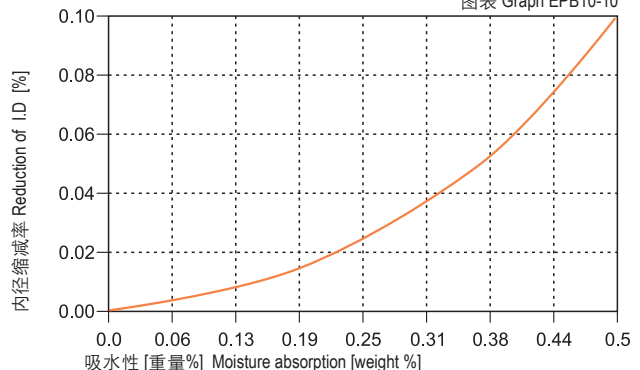

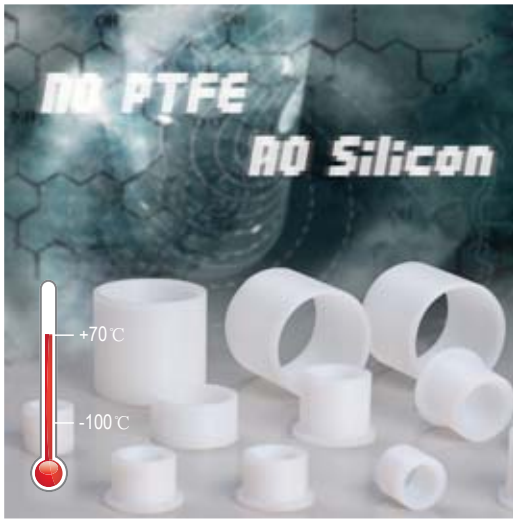

产品特性 Product features

- 低摩擦系数不含PTFE和Silicon的耐磨材料。符合FDA标准可直接与食品接触。可被用于水下或零下100度场合。环境温度高于50度时需要考虑额外限位装置
- 连续使用温度: -100℃/+70℃
- 适合多数低载荷场合
- 适合低速运行, 低噪音要求
- 不含氟和硅, 符合FDA
- Wear resistance material with low friction factor without PTFE and Silicon. It conforms to the FDA standard and could be contacted with food directly. It is suitable for the applications in water or with the temperature under -100℃. If the working temperature is higher than 50℃, additional locating ring is necessary
- Continuous working temperature: -100℃/+70℃
- Suitable for low load
- Low operation speed and low noise
- No PTFE and silicon, FDA grade

材料数据表 Material properties data table

材料性能 Material properties	测试标准 Standard	单位 Unit	CSB-EPB11
颜色 Color	-	-	白色 White
密度 Density	ISO1183	g/cm ³	0.96
最大吸湿率 Max. moisture absorption, 50%RH	ISO62	%	0.1
最大吸水率 Max. water absorption	ISO62	%	0.1
对钢动摩擦系数 Coefficient of sliding friction(steel)	ITS025	μ	0.05-0.15
极限PV值 Max. PV value	ITS026	N/mm ² × m/s	0.20
弯曲模量 Flexural modulus	ISO178	MPa	1200
弯曲强度 Flexural strength	ISO178	MPa	25
最大静载荷 Max. static load	ITS027	MPa	25
最大动载荷 Max. dynamic load	ITS028	MPa	6
邵氏硬度 Shore hardness	ISO868	D	62
连续运行温度 Long-term application temperature	ITS029	℃	+70
短时运行温度 Short-term application temperature	ITS029	℃	+100
最低运行温度 Lowest application temperature	ITS029	℃	-100
导热性 Thermal conductivity	ISO22007	W/m/K	0.20
线性热膨胀系数 Coefficient of thermal expansion	ISO11359	K ⁻¹ × 10 ⁻⁵	19
阻燃等级 Flammability	UL94	Class	HB
体电阻率 Volume resistance	IEC60093	Ω · cm	>10 ¹³
面电阻率 Surface resistance	IEC60093	Ω	>10 ¹²

*ITS: CSB内部测试标准 CSB company's internal test standards.

**除非特殊说明测试温度为23℃ Test temperatures are 23℃ unless otherwise stated.

轴承PV值 PV value

CSB-EPB11塑料轴承最大运行PV值为0.2N/mm² × m/s; 由此决定轴承所承受的载荷与速度成反比, 详细查阅图表EPB11-1。

The max PV value of the CSB-EPB11 plastic bearings is 0.2N/mm² × m/s which determines the load capacity of bearing is inversely proportional to the speed. Please refer to the chart for more detailed information (Graph EPB11-1).

■ PV图表 Permissible PV value for CSB-EPB11

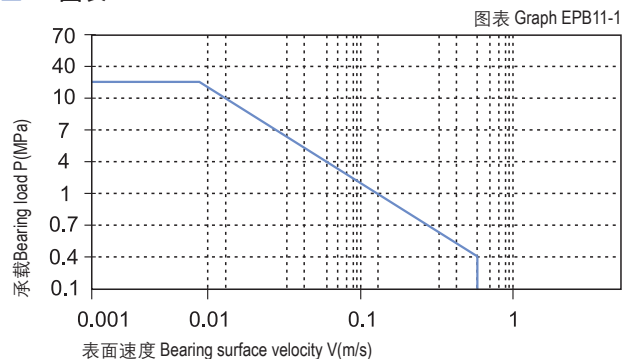

轴承的载荷、速度、温度 Load, speed and temperature

CSB-EPB11塑料轴承可承受最大静载荷为25Mpa，在此载荷下轴承的最大压缩变形量参考图表EPB11-2，轴承实际工作载荷略小于25Mpa，载荷还受到运行速度以及温度的影响，速度越快 (Vmax: 0.5m/s) 会导致摩擦温度上升，而温度上升 (Tmax: 70℃) 会导致轴承的承载能力逐渐减弱，载荷随轴承工作温度变化情况参考图表EPB11-3。

CSB-EPB11 allows the Max static load of 25Mpa, The max compressive deformation rate under the max load is listed in Graph EPB11-2, The actual load capacity of bearing is slightly less than 25Mpa, The bearing load is variable against the speed and temperature, Fast speed (Vmax: 0.5m/s) results into higher temperature (Tmax: 70℃) which decreases the load capacity of the bearing. Please refer to the Graph EPB11-3 for such variation.

轴承的摩擦系数、磨损、轴材料 Friction factor, wear and shaft material

摩擦系数 Friction factor

EPB11-4和EPB11-5表明CSB-EPB11塑料轴承的摩擦系数受运动载荷以及速度的变化非常小，这主要是由于此轴承材料中不含有氟和硅，其低摩擦润滑完全依赖于自身材料特性。EPB11-6表明CSB-EPB11塑料轴承的摩擦系数与轴表面粗糙度有着密切的关联性，我们推荐使用粗糙度为Ra0.2 ~ 0.6um轴与CSB-EPB11塑料轴承配合使用。

Graph EPB11-4 and Graph EPB11-5 shows that the friction factor of CSB-EPB11 is not considerably variable against the changing of the loading and operation speed because there is no Fluorine and Silicon in this material and therefore its low friction feature is completely depended on the material Features. Graph EPB11-6 shows that the friction factor of CSB-EPB11 is sensitive to the shaft roughness. The shaft roughness of Ra0.2~0.6 is recommended for the best performance of CSB-EPB11 bearings.

摩擦系数与轴表面粗糙度关系图表

Coefficient of friction & the surface roughness of shaft

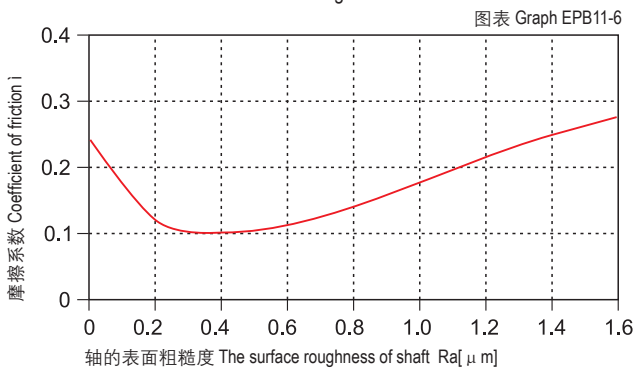

载荷-温度-变形量图表 Load-Temperature deformation

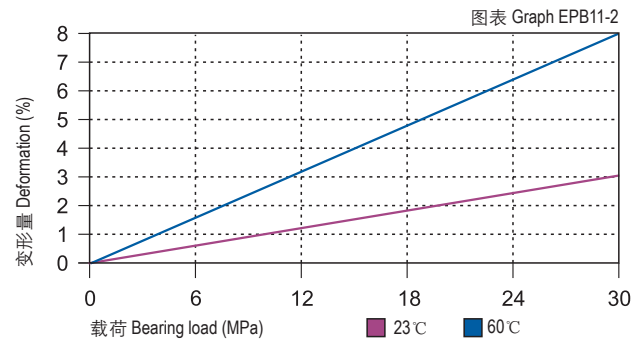

载荷-温度图表 Load-Temperature diagrams

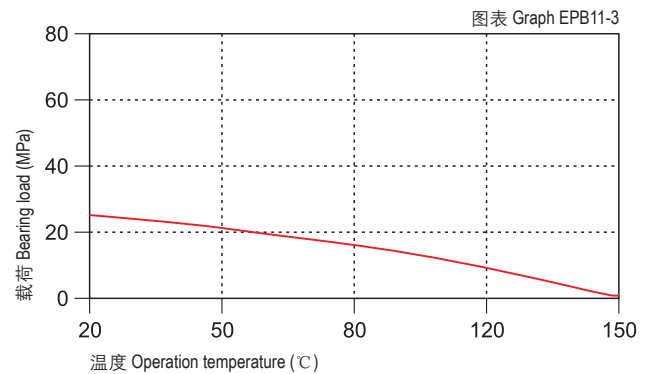

摩擦系数与速度变化关系图表 P=2MPa

Coefficient of friction & the speed of bearing, p = 2 MPa

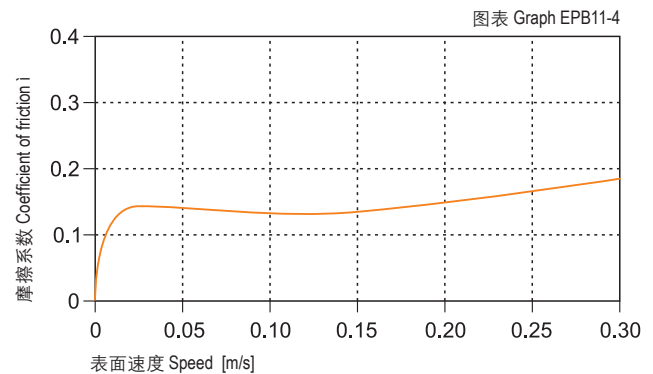

摩擦系数与载荷变化关系图表 v=0.2m/s

Coefficient of friction & the pressure of bearing, v = 0.2 m/s

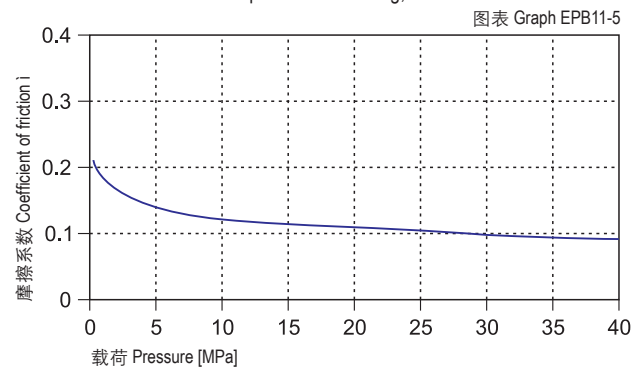

CSB-EPB11	干运行 Dry	油脂 Grease	油 Oil	水 Water
摩擦系数 μ Friction coef.	0.05-0.15	0.09	0.04	0.04

磨损与轴材料 Wearing and shaft material

图表EPB11-7和图表EPB11-8表明了CSB-EPB11塑料轴承在不同轴材料上的运行结果；由此可以看出，硬铬钢轴最适合与CSB-EPB11塑料轴承配合使用。图表EPB11-7表明CSB-EPB11塑料轴承在载荷低于6Mpa时旋转运动比摆动运动更适合，而一旦载荷超过6Mpa则轴承的磨损性能摆动要略优越于旋转运动。

From the testing result to different materials shows in Graph EPB11-7 and Graph EPB11-8, it is found CSB-EPB11 is the best choice for hardened chrome steel shaft. Graph EPB11-7 tells that CSB-EPB11 is with better feature in rotation operation than in oscillation operation when the loading is lower than 6Mpa and the wearing feature of oscillation operation is better than of rotation operation when loading is higher than 6Mpa.

化学抗性 Chemical resistance

CSB-EPB11塑料轴承能抵抗弱酸、弱碱以及各类润滑油的腐蚀。

CSB-EPB11 is good at chemical resistance against mild base, weak acidic medium and various kinds of lubricants.

吸水性 Water absorption

CSB-EPB11塑料轴承在标准大气中的吸湿率为0.1%。浸泡在水中的最高吸水率为0.1%。极低吸水率不会导致轴承发生性能和尺寸变化，CSB-EPB11塑料轴承非常适合用于水下。

The moisture absorption of CSB-EPB11 plastic plain bearings is 0.1% in standard atmosphere. The max. water absorption is 0.1% in water. These values are very low, CSB-EPB11 plastic plain bearings is very well suited for used in water.

抗UV性能 UV resistance

CSB-EPB11塑料轴承长久暴露在紫外线下材料性能逐渐下降。

The material performance of CSB-EPB11 will be lowered if it is exposed in the UV ray for long period.

安装公差 Installation tolerances

CSB-EPB11塑料轴承压装后公差 Tolerances after pressfit

直径 Di. [mm]	CSB-EPB11 D11 [mm]	座孔 Housing H7 [mm]	轴 Shaft h9 [mm]
>0 ~ 3	+0.020 ~ +0.080	0 ~ +0.010	0 ~ -0.025
>3 ~ 6	+0.030 ~ +0.105	0 ~ +0.012	0 ~ -0.030
>6 ~ 10	+0.040 ~ +0.130	0 ~ +0.015	0 ~ -0.036
>10 ~ 18	+0.050 ~ +0.160	0 ~ +0.018	0 ~ -0.043
>18 ~ 30	+0.065 ~ +0.195	0 ~ +0.021	0 ~ -0.052
>30 ~ 50	+0.080 ~ +0.240	0 ~ +0.025	0 ~ -0.062
>50 ~ 80	+0.100 ~ +0.290	0 ~ +0.030	0 ~ -0.074

在不同轴材料上旋转时的磨损量 $p=2\text{MPa}$, $v=0.2\text{m/s}$

Wear under rotating with different shaft materials, $p = 2 \text{ MPa}$, $v = 0.2 \text{ m/s}$

图表 Graph EPB11-7

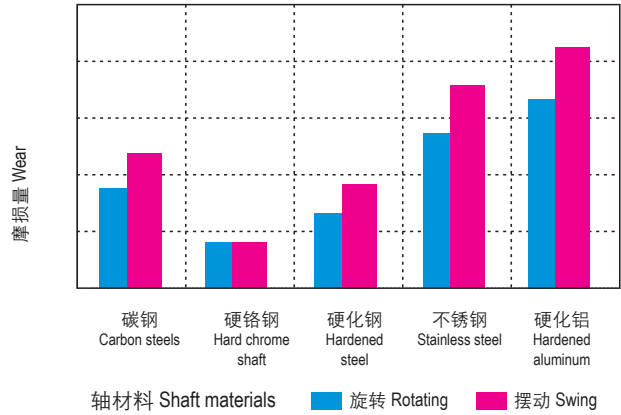

旋转磨损随轴材料与压力变化关系 $v=0.2\text{m/s}$

Wear & pressure under rotating with different shaft materials, $v = 0.2 \text{ m/s}$

图表 Graph EPB11-8

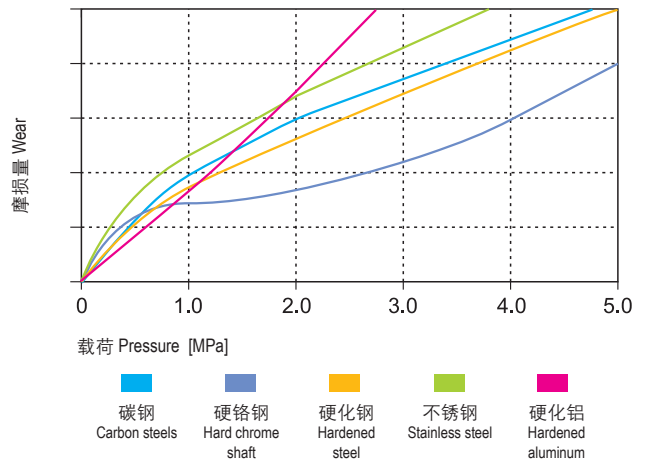



产品特性 Product features

- 高载荷下摇摆运动出色的耐磨材料。高负荷下的低成本解决方案
- 连续使用温度: -40℃/+135℃
- 承受较高载荷
- 适合用于摆动场合
- 抗冲击性能较好
- 抗污垢能力强
- Good wear resistance material suitable for high load and oscillation motions. It is an economic solution for high load applications
- Continuous working temperature: -40℃/+135℃
- Suitable for high load operation
- Good for oscillating operation
- Good impact resistance
- Containment prevention ability

● 标准产品规格表 Standard specifications: P128

材料数据表 Material properties data table

材料性能 Material properties	测试标准 Standard	单位 Unit	CSB-EPB12
颜色 Color	-	-	黑色 Black
密度 Density	ISO1183	g/cm ³	1.32
最大吸湿率 Max. moisture absorption, 50%RH	ISO62	%	0.9
最大吸水率 Max. water absorption	ISO62	%	4.9
对钢动摩擦系数 Coefficient of sliding friction(steel)	ITS025	μ	0.05-0.20
极限PV值 Max. PV value	ITS026	N/mm ² × m/s	0.55
弯曲模量 Flexural modulus	ISO178	MPa	2200
弯曲强度 Flexural strength	ISO178	MPa	100
最大静载荷 Max. static load	ITS027	MPa	75
最大动载荷 Max. dynamic load	ITS028	MPa	43
邵氏硬度 Shore hardness	ISO868	D	83
连续运行温度 Long-term application temperature	ITS029	℃	+135
短时运行温度 Short-term application temperature	ITS029	℃	+155
最低运行温度 Lowest application temperature	ITS029	℃	-40
导热性 Thermal conductivity	ISO22007	W/m/K	0.24
线性热膨胀系数 Coefficient of thermal expansion	ISO11359	K ⁻¹ × 10 ⁻⁵	5
阻燃等级 Flammability	UL94	Class	HB
体电阻率 Volume resistance	IEC60093	Ω · cm	>10 ¹¹
面电阻率 Surface resistance	IEC60093	Ω	>10 ¹¹

*ITS: CSB内部测试标准 CSB company's internal test standards.

**除非特殊说明测试温度为23℃ Test temperatures are 23℃ unless otherwise stated.

轴承PV值 PV value

CSB-EPB12塑料轴承最大运行PV值为0.55N/mm² × m/s; 由此决定轴承所承受的载荷与速度成反比, 详细查阅图表EPB12-1。

The max PV value of the CSB-EPB12 plastic bearings is 0.55N/mm² × m/s which determines the load capacity of bearing is inversely proportional to the speed. Please refer to the chart for more detailed information (Graph EPB12-1).

■ PV图表 Permissible PV value for CSB-EPB12

图表 Graph EPB12-1

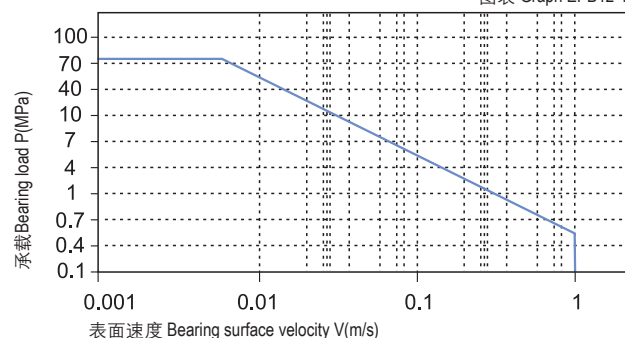

轴承的载荷、速度、温度 Load, speed and temperature

CSB-EPB12塑料轴承可承受最大静载荷为75Mpa，在此载荷下轴承的最大压缩变形量参考图表EPB12-2，轴承实际工作载荷略小于75Mpa，载荷还受到运行速度以及温度的影响，速度越快 (Vmax: 1.0m/s) 会导致摩擦温度上升，而温度上升 (Tmax: 135℃) 会导致轴承的承载能力逐渐减弱，载荷随轴承工作温度变化情况参考图表EPB12-3。

CSB-EPB12 allows the Max static load of 75Mpa, The max compressive deformation rate under the max load is listed in Graph EPB12-2, The actual load capacity of bearing is slightly less than 75Mpa, The bearing load is variable against the speed and temperature, Fast speed (Vmax: 1.0m/s) results into higher temperature (Tmax: 135℃) which decreases the load capacity of the bearing. Please refer to the Graph EPB12-3 for such variation.

轴承的摩擦系数、磨损、轴材料 Friction factor, wear and shaft material

摩擦系数 Friction factor

图表EPB12-4表明CSB-EPB12塑料轴承的摩擦系数在载荷保持不变的情况下受速度变化影响比较小；同样在图表EPB12-5表明CSB-EPB12塑料轴承在速度保持不变的情况下受载荷变化的影响相对也比较小；此轴承为所有滑动轴承中摩擦系数不受运行速度以及载荷影响较大的典型轴承。根据图表EPB12-6显示CSB-EPB12塑料轴承的摩擦系数在超过Ra0.4后轴表面粗糙度几乎对轴承的摩擦系数没有任何影响，我们推荐使用轴表面粗糙度为Ra0.1 ~ 0.4um。

Graph EPB12-4 shows that the friction factor of CSB-EPB12 is not considerably affected by the operation speed when the loading is stable. At the meantime, Graph EPB12-5 shows that the friction factor of CSB-EPB12 is not considerably affected by the loading when the operation speed is stable. This bearing is the only typical material whose friction factor is not sensitive to the operation speed and loading. Graph EPB12-6 tells that the friction factor of CSB-EPB12 will not be affected by the shaft roughness when the shaft roughness is better than Ra0.4. The recommended Shaft roughness is Ra0.1~0.4.

摩擦系数与轴表面粗糙度关系图表

Coefficient of friction & the surface roughness of shaft

图表 Graph EPB12-6

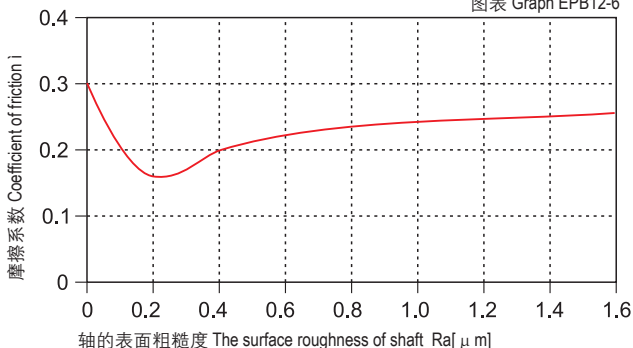

载荷-温度-变形量图表 Load-Temperature deformation

图表 Graph EPB12-2

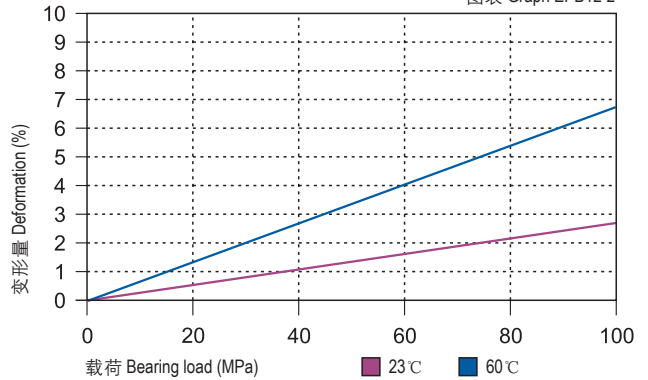

载荷-温度图表 Load-Temperature diagrams

图表 Graph EPB12-3

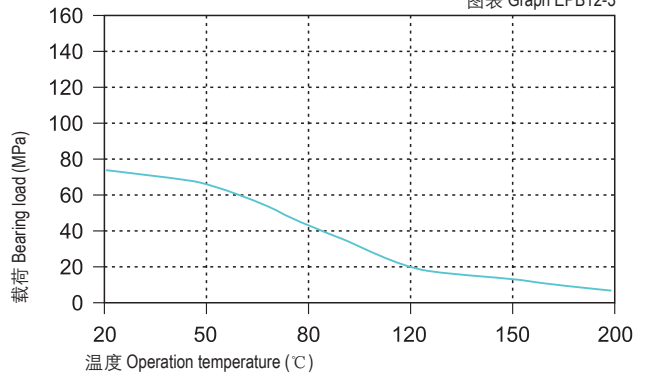

摩擦系数与速度变化关系图表 P=2MPa

Coefficient of friction & the speed of bearing, p = 2 MPa

图表 Graph EPB12-4

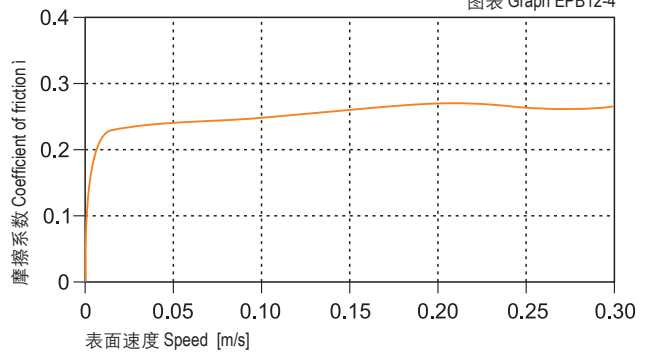

摩擦系数与载荷变化关系图表 v=0.2m/s

Coefficient of friction & the pressure of bearing, v = 0.2 m/s

图表 Graph EPB12-5

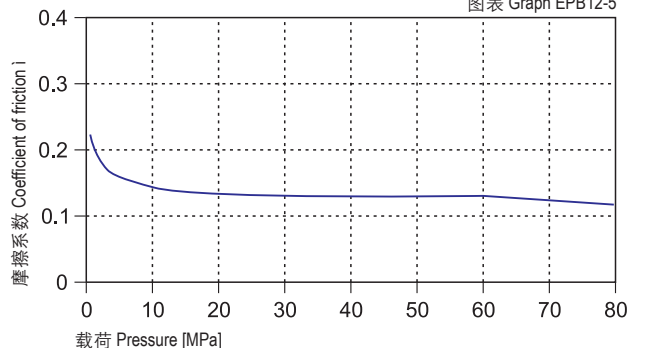

CSB-EPB12	干运行 Dry	油脂 Grease	油 Oil	水 Water
摩擦系数 μ Friction coef.	0.05-0.20	0.09	0.04	0.04

磨损与轴材料 Wearing and shaft material

图表EPB12-7与图表EPB12-8表明CSB-EPB12塑料轴承比较适合采用硬铬钢轴或硬化钢轴；图表EPB12-7表明CSB-EPB12塑料轴承在做摆动运动下的磨损性能要优越于在旋转运动下的磨损性能。图表EPB12-8表明CSB-EPB12塑料轴承在摆动运动时选择硬铬钢轴和硬化钢轴比较适合，在旋转运动中也是选择硬铬钢轴和硬化钢轴比较理想。

Graph EPB12-7 and Graph EPB12-8 tells that CSB-EPB12 is suitable for both hard chrome steel shaft and hardened steel shaft. Graph EPB12-8 shows that the wearing feature of CSB-EPB12 is better in oscillation operation than in rotation operation. Hardened chrome steel shaft and hardened steel shaft is the better choice under oscillation operation and hardened steel shaft and hardened chrome steel shaft is the better choice under rotation operation.

化学抗性 Chemical resistance

CSB-EPB12塑料轴承能抵抗弱碱以及各类润滑油的腐蚀。

CSB-EPB12 is good at chemical resistance against weak acidic medium and various kinds of lubricants.

吸水性 Water absorption

CSB-EPB12塑料轴承在标准大气中的吸湿率为0.9%。浸泡在水中最高吸水率为4.9%。由于高吸水率的特性，我们必须考虑此轴承的应用环境。

The moisture absorption of CSB-EPB12 plastic plain bearings is 0.9% in standard atmosphere. The max. water absorption is 4.9% in water. The application environment has to be considered due to the high water absorption properties.

抗UV性能 UV resistance

CSB-EPB12塑料轴承长久暴露在紫外线下长久后材料可能会变脆，不能承受冲击力。

CSB-EPB12 can become brittle and lost its impact resistance when it is exposed into UV ray for a certain period of time.

安装公差 Installation tolerances

CSB-EPB12塑料轴承压装后公差 Tolerances after pressfit

直径 Di [mm]	CSB-EPB12 E10 [mm]	座孔 Housing H7 [mm]	轴 Shaft h9 [mm]
>0 ~ 3	+0.014 ~ +0.054	0 ~ +0.010	0 ~ -0.025
>3 ~ 6	+0.020 ~ +0.068	0 ~ +0.012	0 ~ -0.030
>6 ~ 10	+0.025 ~ +0.083	0 ~ +0.015	0 ~ -0.036
>10 ~ 18	+0.032 ~ +0.102	0 ~ +0.018	0 ~ -0.043
>18 ~ 30	+0.040 ~ +0.124	0 ~ +0.021	0 ~ -0.052
>30 ~ 50	+0.050 ~ +0.150	0 ~ +0.025	0 ~ -0.062
>50 ~ 80	+0.060 ~ +0.180	0 ~ +0.030	0 ~ -0.074
>80 ~ 120	+0.072 ~ +0.212	0 ~ +0.035	0 ~ -0.087
>120 ~ 180	+0.085 ~ +0.245	0 ~ +0.040	0 ~ -0.100

在不同轴材料上旋转时的磨损量 $p=2\text{MPa}$, $v=0.2\text{m/s}$

Wear under rotating with different shaft materials, $p = 2 \text{ MPa}$, $v = 0.2 \text{ m/s}$

图表 Graph EPB12-7

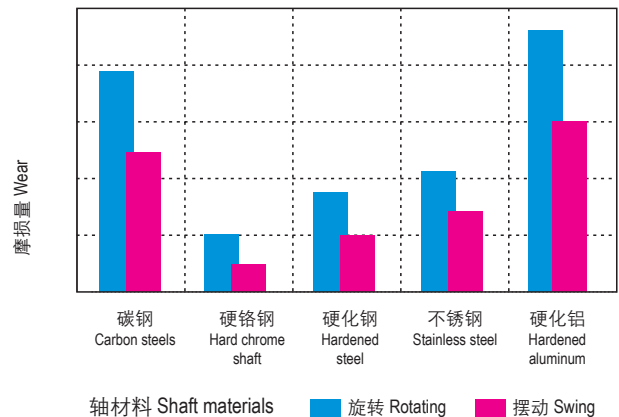

旋转磨损随轴材料与压力变化关系 $v=0.2\text{m/s}$

Wear & pressure under rotating with different shaft materials, $v = 0.2 \text{ m/s}$

图表 Graph EPB12-8

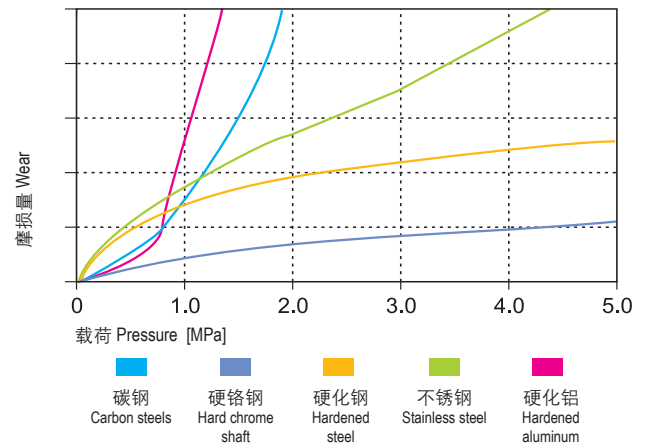

吸水性的影响

Effect of moisture absorption on EPB12 bearings

图表 Graph EPB12-9

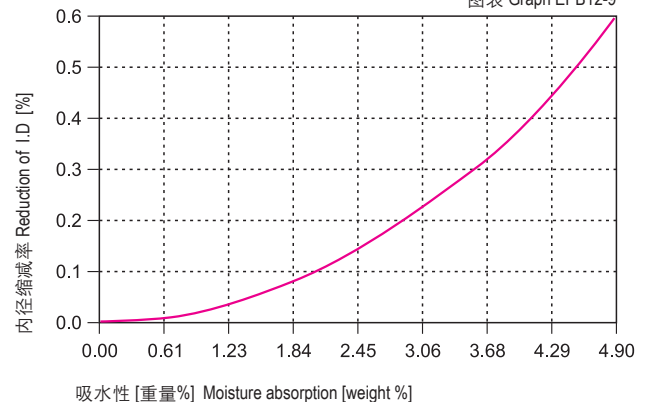



● 标准产品规格表 Standard specifications: P124

产品特性 Product features

- 低摩擦系数和高耐磨性结合。旋转、直线和摆动应用中耐磨性和摩擦系数几乎保持一致。对轴材料硬度要求较低。不适合极高载荷。
- 连续使用温度: -50℃/+90℃
- 适合于运行、免维护
- 不同轴材料磨损很小
- 较低的摩擦系数
- 适用于软轴
- 吸水性较低
- Low friction and high wear resistance. It could maintain a good stable wear resistance and friction factor for the rotation, linear and oscilation movement. It has no critical hardness requirement to the shaft
- Continuous working temperature: -50℃/+90℃
- Maintenance-free dry operation
- Small wear off amount against various shaft materials
- Lower friction
- Suitable for soft shaft
- Low water absorption

材料数据表 Material properties data table

材料性能 Material properties	测试标准 Standard	单位 Unit	CSB-EPB13
颜色 Color	-	-	黄色 Yellow
密度 Density	ISO1183	g/cm ³	1.48
最大吸湿率 Max. moisture absorption, 50%RH	ISO62	%	0.3
最大吸水率 Max. water absorption	ISO62	%	1.3
对钢动摩擦系数 Coefficient of sliding friction(steel)	ITS025	μ	0.05-0.15
极限PV值 Max. PV value	ITS026	N/mm ² × m/s	0.40
弯曲模量 Flexural modulus	ISO178	MPa	2600
弯曲强度 Flexural strength	ISO178	MPa	60
最大静载荷 Max. static load	ITS027	MPa	35
最大动载荷 Max. dynamic load	ITS028	MPa	14
邵氏硬度 Shore hardness	ISO868	D	74
连续运行温度 Long-term application temperature	ITS029	℃	+90
短时运行温度 Short-term application temperature	ITS029	℃	+120
最低运行温度 Lowest application temperature	ITS029	℃	-50
导热性 Thermal conductivity	ISO22007	W/m/K	0.25
线性热膨胀系数 Coefficient of thermal expansion	ISO11359	K ⁻¹ × 10 ⁻⁵	10
阻燃等级 Flammability	UL94	Class	HB
体电阻率 Volume resistance	IEC60093	Ω · cm	>10 ¹³
面电阻率 Surface resistance	IEC60093	Ω	>10 ¹²

*ITS: CSB内部测试标准 CSB company's internal test standards.

**除非特殊说明测试温度为23℃ Test temperatures are 23℃ unless otherwise stated.

轴承PV值 PV value

CSB-EPB13塑料轴承最大运行PV值为0.4N/mm² × m/s; 由此决定轴承所承受的载荷与速度成反比, 详细查阅图表EPB13-1。

The max PV value of the CSB-EPB13 plastic bearings is 0.4N/mm² × m/s which determines the load capacity of bearing is inversely proportional to the speed. Please refer to the chart for more detailed information (Graph EPB13-1).

■ PV图表 Permissible PV value for CSB-EPB13

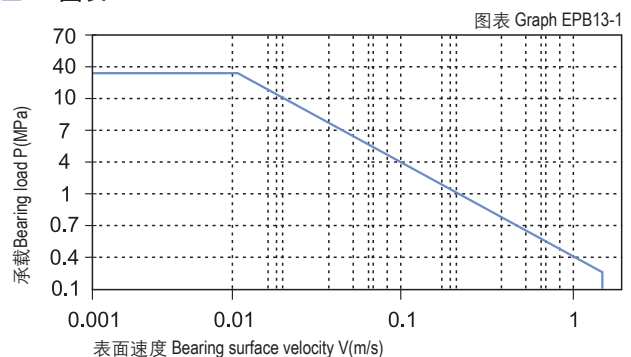

轴承的载荷、速度、温度 Load, speed and temperature

CSB-EPB13塑料轴承可承受最大静载荷为35Mpa，在此载荷下轴承的最大压缩变形量参考图表EPB13-2，轴承实际工作载荷略小于35Mpa，载荷还受到运行速度以及温度的影响，速度越快 (Vmax: 1.5m/s) 会导致摩擦温度上升，而温度上升 (Tmax: 90℃) 会导致轴承的承载能力逐渐减弱，载荷随轴承工作温度变化情况参考图表EPB13-3。

CSB-EPB13 allows the Max static load of 35Mpa, The max compressive deformation rate under the max load is listed in Graph EPB13-2, The actual load capacity of bearing is slightly less than 35Mpa, The bearing load is variable against the speed and temperature, Fast speed (Vmax: 1.5m/s) results into higher temperature (Tmax: 90℃) which decreases the load capacity of the bearing. Please refer to the Graph EPB13-3 for such variation.

轴承的摩擦系数、磨损、轴材料 Friction factor, wear and shaft material

摩擦系数 Friction factor

图表EPB13-4表明CSB-EPB13塑料轴承摩擦系数在载荷一定随着运动速度的变化率比较小；图表EPB13-5在运动速度一定摩擦系数在载荷小于10Mpa时变化率较大，而在载荷大于10Mpa是变化率也逐渐减小；图表EPB13-6表明CSB-EPB13塑料轴承材料的粗糙度越大摩擦系数也随之越大，但当粗糙度大于Ra0.5时摩擦系数也趋于平稳；此轴承适合用于轴粗糙度为Ra=0.1~0.4um；

CSB-EPB13 Bearing friction factor varies only little amount along with the operation speed changing (See Graph EPB13-4). When the operation speed is relatively stable, the friction factor varies a lot while the load is less than 10Mpa (see Graph EPB13-5). At the same time, it does not vary much when the loading is greater than 10Mpa. Rough surface may result into the increasing of friction factor of the CSB-EPB13 material but when the roughness of the surface is greater than Ra0.5, the friction factor will remain relatively stable again. The recommended shaft surface roughness is Ra0.1~Ra0.4 for the CSB-EPB13 material.

摩擦系数与轴表面粗糙度关系图表

Coefficient of friction & the surface roughness of shaft

图表 Graph EPB13-6

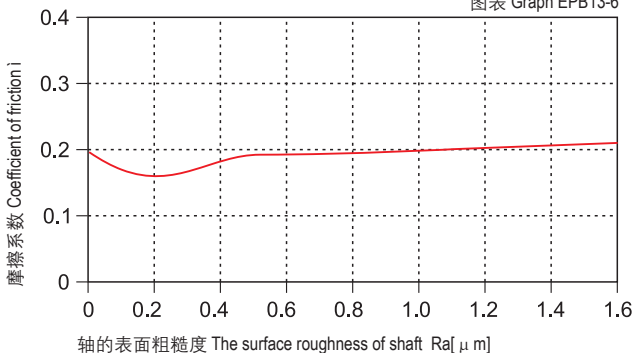

载荷-温度-变形量图表 Load-Temperature deformation

图表 Graph EPB13-2

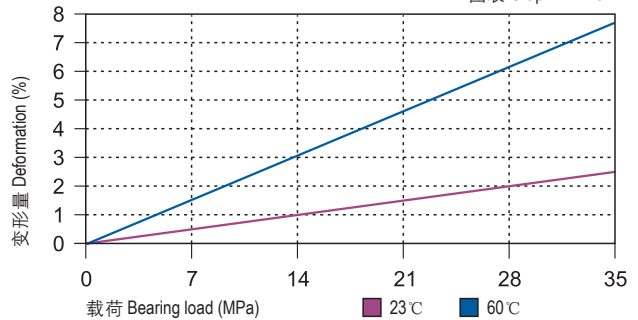

载荷-温度图表 Load-Temperature diagrams

图表 Graph EPB13-3

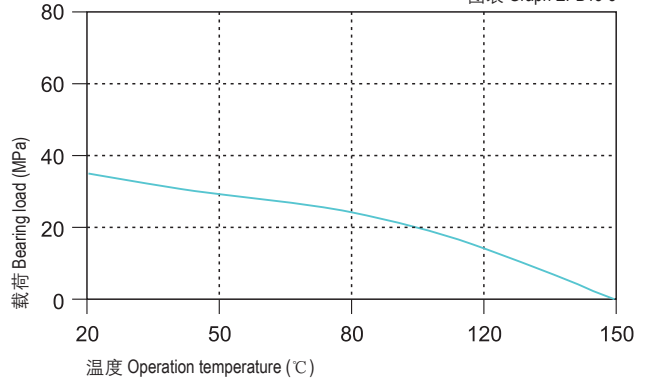

摩擦系数与速度变化关系图表 P=2MPa

Coefficient of friction & the speed of bearing, p = 2 MPa

图表 Graph EPB13-4

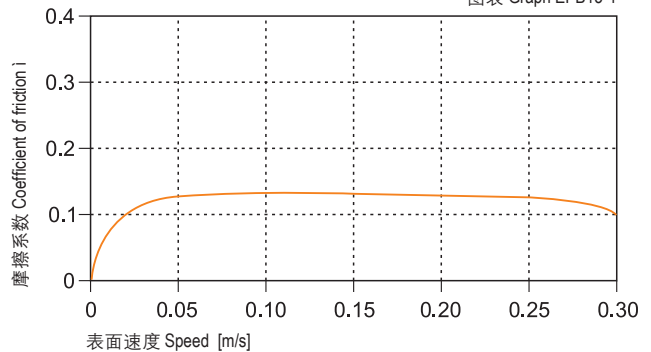

摩擦系数与载荷变化关系图表 v=0.2m/s

Coefficient of friction & the pressure of bearing, v = 0.2 m/s

图表 Graph EPB13-5

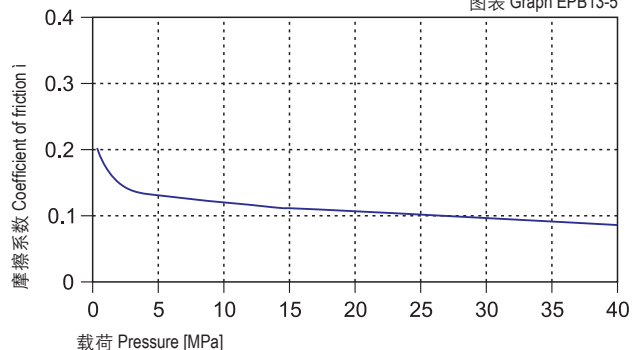

CSB-EPB13	干运行 Dry	油脂 Grease	油 Oil	水 Water
摩擦系数 μ Friction coef.	0.05~0.15	0.09	0.04	0.04

磨损与轴材料 Wearing and shaft material

图表EPB13-7是CSB-EPB13塑料轴承在不同轴上运行磨损测试结果；图表EPB13-8表明当CSB-EPB13塑料轴承在载荷低于2Mpa下运行时适合不同的轴材料，但在硬铬轴上的摩擦磨损最小；当载荷继续增大时，此轴承在不锈钢轴的耐磨性能尤为特出。图表EPB13-7表明CSB-EPB13塑料轴承比较适合用于旋转运动，但无论是在旋转运动还是摆动运动此轴承在硬铬轴上的运用效果是更好的。

Test of the bearing against various shaft materials shows that the material CSB-EPB13 features the best performance where the shaft material is hard chrome steel with loading less than 2Mpa. (See Graph EPB13-7). Therefore, the higher the load is increased, the wear-resistance of the bearing will be better against the stainless steel shaft. Refer to Graph EPB13-7, the material CSB-EPB13 is suitable for rotation operation. Either to be used under rotation operation or the oscillation operation, it is the best suitable material for the application against hard chrome steel shaft.

化学抗性 Chemical resistance

CSB-EPB13塑料轴承能抵抗弱碱、弱酸以及各类润滑油的腐蚀。CSB-EPB13 is good at chemical resistance against mild base, weak acidic medium and various kinds of lubricants.

吸水性 Water absorption

CSB-EPB13塑料轴承在标准大气中的吸湿率为0.3%。浸泡在水中最高吸水率为1.3%。较低的吸水率只有在极端应用中才需要更改轴承设计。

The moisture absorption of CSB-EPB13 plastic bearings is 0.3% in standard atmosphere. The max. water absorption is 1.3% in water. These values are so low that design changes due to absorption are only necessary in extreme applications.

抗UV性能 UV resistance

CSB-EPB13塑料轴承长久暴露在紫外线下颜色基本不会改变。材料的硬度、抗压强度和耐磨性都不会改变。

CSB-EPB13 can maintain its color unchanged when it is exposed into the UV ray. The hardness, Compressive strength and wear resistance of the material is also stable under such condition.

安装公差 Installation tolerances

CSB-EPB13塑料轴承压装后公差 Tolerances after pressfit

直径 Di. [mm]	CSB-EPB13 E10 [mm]	座孔 Housing H7 [mm]	轴 Shaft h9 [mm]
>0 ~ 3	+0.014 ~ +0.054	0 ~ +0.010	0 ~ -0.025
>3 ~ 6	+0.020 ~ +0.068	0 ~ +0.012	0 ~ -0.030
>6 ~ 10	+0.025 ~ +0.083	0 ~ +0.015	0 ~ -0.036
>10 ~ 18	+0.032 ~ +0.102	0 ~ +0.018	0 ~ -0.043

在不同轴材料上旋转时的磨损量 $p=2\text{MPa}$, $v=0.2\text{m/s}$ Wear under rotating with different shaft materials, $p = 2 \text{ MPa}$, $v = 0.2 \text{ m/s}$

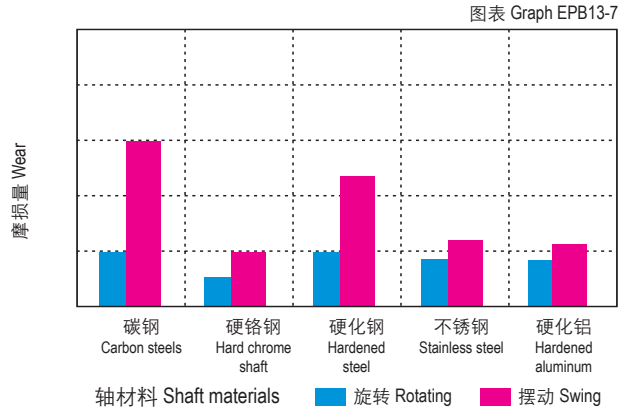

旋转磨损随轴材料与压力变化关系 $v=0.2\text{m/s}$ Wear & pressure under rotating with different shaft materials, $v = 0.2 \text{ m/s}$

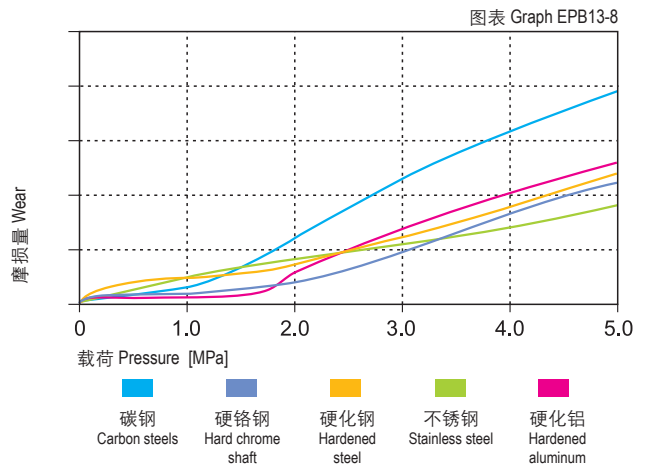

吸水性的影响 Effect of moisture absorption on EPB13 bearings

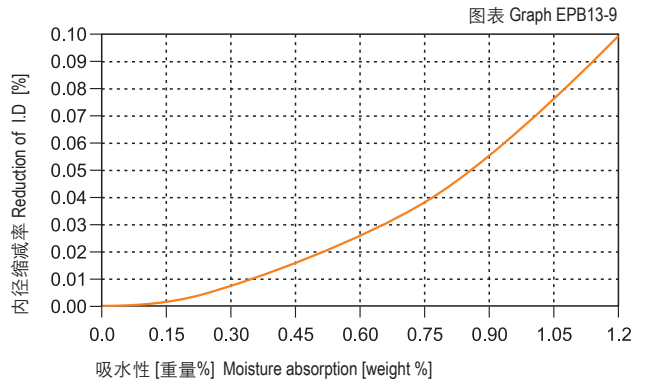

直径 Di. [mm]	CSB-EPB13 E10 [mm]	座孔 Housing H7 [mm]	轴 Shaft h9 [mm]
>18 ~ 30	+0.040 ~ +0.124	0 ~ +0.021	0 ~ -0.052
>30 ~ 50	+0.050 ~ +0.150	0 ~ +0.025	0 ~ -0.062
>50 ~ 80	+0.060 ~ +0.180	0 ~ +0.030	0 ~ -0.074
>80 ~ 120	+0.072 ~ +0.212	0 ~ +0.035	0 ~ -0.087
>120 ~ 180	+0.085 ~ +0.245	0 ~ +0.040	0 ~ -0.100



● 标准产品规格表 Standard specifications: P138

产品特性 Product features

- 极好的耐磨性材料。对轴材料和粗糙度要求较低。在粉尘恶劣环境中同样保持良好的耐磨性能
- 连续使用温度: -40°C/+90°C
- 适合于运行、免维护
- 不同轴材料磨损很小
- 较低的摩擦系数
- 适用于软轴
- 吸水性较低
- Good wear resistance and with low hardness and roughness requirement for the shaft material. The wear resistance of the material will not be weekend even under the dust environment
- Continuous working temperature: -40°C/+90°C
- Maintenance-free dry operation
- Small wear off amount against various shaft materials
- Lower friction
- Low water absorption

材料数据表 Material properties data table

材料性能 Material properties	测试标准 Standard	单位 Unit	CSB-EPB15
颜色 Color	-	-	黄色 Yellow
密度 Density	ISO1183	g/cm ³	1.30
最大吸湿率 Max. moisture absorption, 50%RH	ISO62	%	1.3
最大吸水率 Max. water absorption	ISO62	%	6.5
对钢动摩擦系数 Coefficient of sliding friction(steel)	ITS025	μ	0.05-0.15
极限PV值 Max. PV value	ITS026	N/mm ² × m/s	0.90
弯曲模量 Flexural modulus	ISO178	MPa	4000
弯曲强度 Flexural strength	ISO178	MPa	130
最大静载荷 Max. static load	ITS027	MPa	70
最大动载荷 Max. dynamic load	ITS028	MPa	35
邵氏硬度 Shore hardness	ISO868	D	79
连续运行温度 Long-term application temperature	ITS029	°C	+90
短时运行温度 Short-term application temperature	ITS029	°C	+180
最低运行温度 Lowest application temperature	ITS029	°C	-40
导热性 Thermal conductivity	ISO22007	W/m/K	0.24
线性热膨胀系数 Coefficient of thermal expansion	ISO11359	K ⁻¹ × 10 ⁻⁵	8
阻燃等级 Flammability	UL94	Class	HB
体电阻率 Volume resistance	IEC60093	Ω · cm	>10 ¹³
面电阻率 Surface resistance	IEC60093	Ω	>10 ¹²

*ITS: CSB内部测试标准 CSB company's internal test standards.

**除非特殊说明测试温度为23°C Test temperatures are 23°C unless otherwise stated.

轴承PV值 PV value

CSB-EPB15塑料轴承最大运行PV值为0.9N/mm² × m/s; 由此决定轴承所承受的载荷与速度成反比, 详细查阅图表EPB15-1。

The max PV value of the CSB-EPB15 plastic bearings is 0.9N/mm² × m/s which determines the load capacity of bearing is inversely proportional to the speed. Please refer to the chart for more detailed information (Graph EPB15-1).

■ PV图表 Permissible PV value for CSB-EPB15

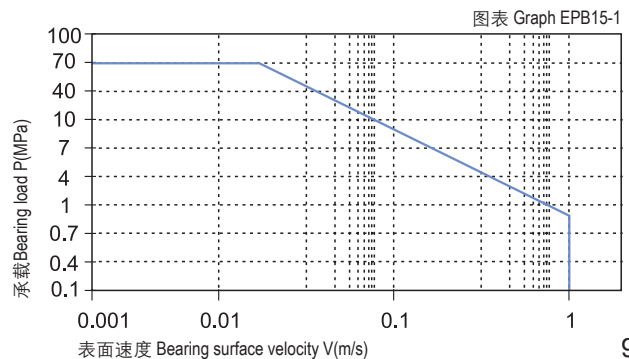

轴承的载荷、速度、温度 Load, speed and temperature

CSB-EPB15塑料轴承可承受最大静载荷为70Mpa，在此载荷下轴承的最大压缩变形量参考图表EPB15-2，轴承实际工作载荷略小于70Mpa，载荷还受到运行速度以及温度的影响，速度越快 (Vmax: 1.0m/s) 会导致摩擦温度上升，而温度上升 (Tmax: 90℃) 会导致轴承的承载能力逐渐减弱，载荷随轴承工作温度变化情况参考图表EPB15-3。

CSB-EPB15 allows the Max static load of 70Mpa, The max compressive deformation rate under the max load is listed in Graph EPB15-2, The actual load capacity of bearing is slightly less than 70Mpa, The bearing load is variable against the speed and temperature, Fast speed (Vmax: 1.0m/s) results into higher temperature (Tmax: 90℃) which decreases the load capacity of the bearing. Please refer to the Graph EPB15-3 for such variation.

轴承的摩擦系数、磨损、轴材料 Friction factor, wear and shaft material

摩擦系数 Friction factor

图表EPB15-4表明CSB-EPB15塑料轴承的摩擦系数随着运动速度的变化影响较小，而图表EPB15-5表明CSB-EPB15塑料轴承的摩擦系数随着载荷的增加明显减小，在载荷超过20Mpa是逐渐趋于平稳；图表EPB15-6表明CSB-EPB15塑料轴承的摩擦系数受轴粗糙度的影响也相对比较小；虽然如此，我们还是建议轴的表面不能太光滑，也不能过于出差，推荐使用轴的粗糙度为Ra0.3 ~ 0.6μm。

Graph EPB15-4 shows that the friction factor of CSB-EPB15 is not sensitive to the operation speed and Graph EPB15-5 shows that the friction factor is CSB-EPB15 is decreased along with the loading increasing and become stable when the loading is over 20Mpa. Graph EPB15-6 tells that the friction factor of CSB-EPB15 is also not sensitive to the shaft roughness but we still recommend the shaft roughness to be Ra0.3~0.6.

摩擦系数与轴表面粗糙度关系图表 Coefficient of friction & the surface roughness of shaft

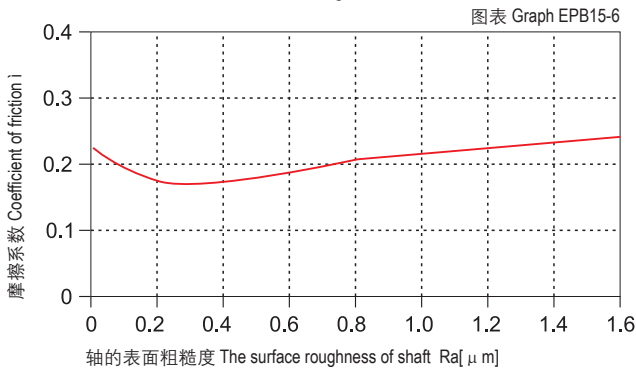

载荷-温度-变形量图表 Load-Temperature deformation

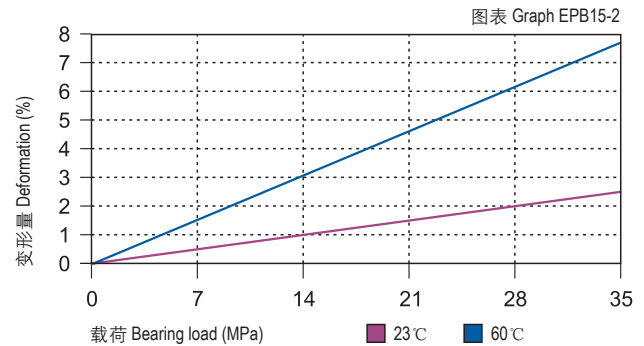

载荷-温度图表 Load-Temperature diagrams

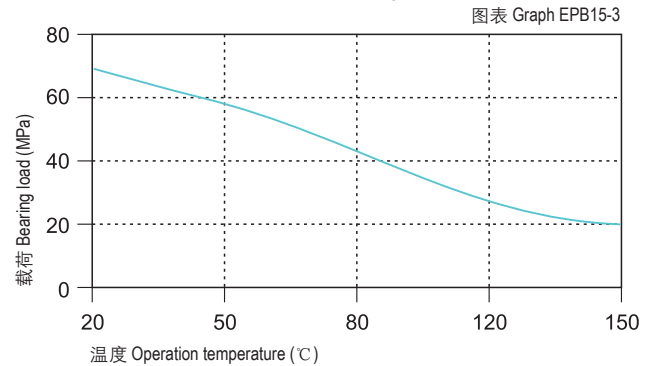

摩擦系数与速度变化关系图表 P=2MPa Coefficient of friction & the speed of bearing, p = 2 MPa

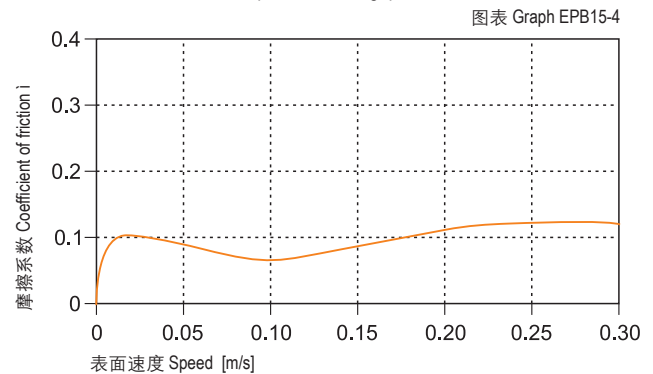

摩擦系数与载荷变化关系图表 v=0.2m/s Coefficient of friction & the pressure of bearing, v = 0.2 m/s

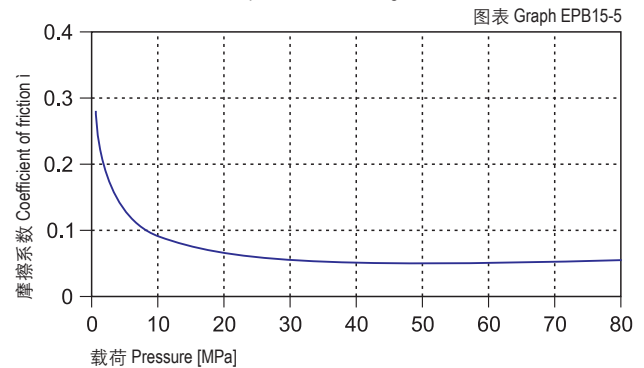

CSB-EPB15	干运行 Dry	油脂 Grease	油 Oil	水 Water
摩擦系数 μ Friction coef.	0.05-0.15	0.09	0.04	0.04

磨损与轴材料 Wearing and shaft material

图表EPB15-7表明CSB-EPB15塑料轴承在2Mpa下做旋转运动时，磨损随着轴材料的变化较大；通过实验表明CSB-EPB15塑料轴承在做旋转运动时比较适合用于硬轴，高速钢轴和硬铬轴上用于CSB-EPB15塑料轴承能获得良好的运行效果。图表EPB15-8表明硬铬轴更适合用于高载荷下的CSB-EPB15塑料轴承，随着载荷的不断增加，轴承的磨损速率却变化较小。

Graph EPB15-7 shows that the wearing of CSB-EPB15 is sensitive to different materials under rotation operation with the loading of 2Mpa. It is suitable for hardened shaft, high speed steel shaft and hardened chrome steel shaft in the rotation operation. Hardened chrome steel shaft is the best choice for CSB-EPB15 (Graph EPB15-8). The wearing will be decreased as long as the loading increasing.

化学抗性 Chemical resistance

CSB-EPB15塑料轴承能抵抗弱碱以及各类润滑油的腐蚀。

CSB-EPB15 is good at chemical resistance against weak acidic medium and various kinds of lubricants.

吸水性 Water absorption

CSB-EPB15塑料轴承在标准大气中的吸湿率为1.3%。浸泡在水中最高吸水率为6.5%。由于高吸水率的特性，我们必须考虑此轴承的应用环境。

The moisture absorption of CSB-EPB15 plastic plain bearings is 1.3% in standard atmosphere. The max. water absorption is 6.5% in water. The application environment has to be considered due to the high water absorption properties.

抗UV性能 UV resistance

CSB-EPB15塑料轴承长久暴露在紫外线下颜色基本不会改变。

材料性能基本都不会发生改变。

CSB-EPB15 can maintain its color unchanged when it is exposed into the UV ray. The material performance stays stable.

安装公差 Installation tolerances

CSB-EPB15塑料轴承压装后公差 Tolerances after pressfit

直径 Di. [mm]	CSB-EPB15 E10 [mm]	座孔 Housing H7 [mm]	轴 Shaft h9 [mm]
>0 ~ 3	+0.014 ~ +0.054	0 ~ +0.010	0 ~ -0.025
>3 ~ 6	+0.020 ~ +0.068	0 ~ +0.012	0 ~ -0.030
>6 ~ 10	+0.025 ~ +0.083	0 ~ +0.015	0 ~ -0.036
>10 ~ 18	+0.032 ~ +0.102	0 ~ +0.018	0 ~ -0.043
>18 ~ 30	+0.040 ~ +0.124	0 ~ +0.021	0 ~ -0.052
>30 ~ 50	+0.050 ~ +0.150	0 ~ +0.025	0 ~ -0.062
>50 ~ 80	+0.060 ~ +0.180	0 ~ +0.030	0 ~ -0.074
>80 ~ 120	+0.072 ~ +0.212	0 ~ +0.035	0 ~ -0.087
>120 ~ 180	+0.085 ~ +0.245	0 ~ +0.040	0 ~ -0.100

在不同轴材料上旋转时的磨损量 $p=2\text{MPa}$, $v=0.2\text{m/s}$ Wear under rotating with different shaft materials, $p = 2 \text{ MPa}$, $v = 0.2 \text{ m/s}$

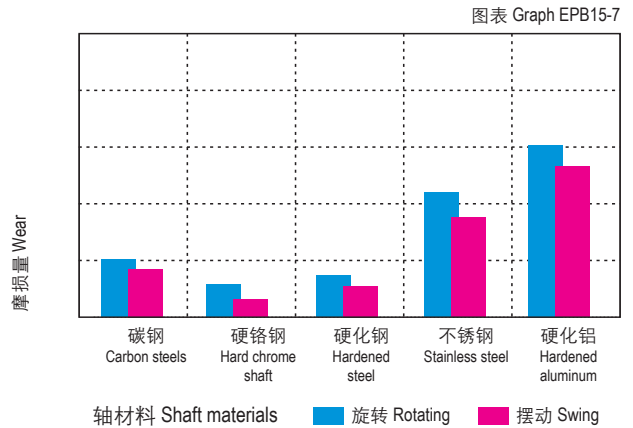

旋转磨损随轴材料与压力变化关系 $v=0.2\text{m/s}$ Wear & pressure under rotating with different shaft materials, $v = 0.2 \text{ m/s}$

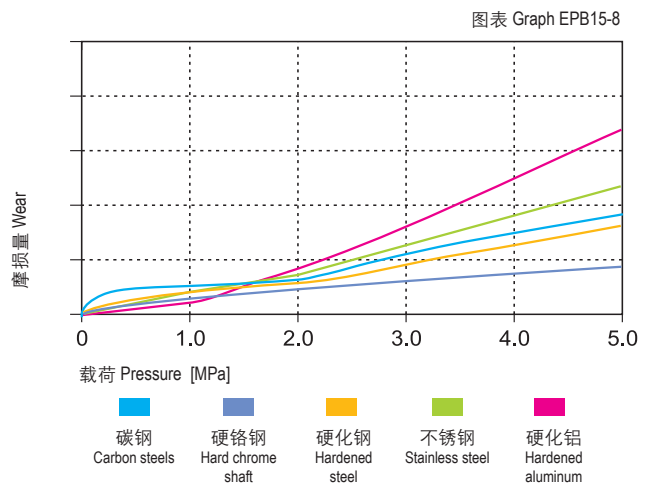

吸水性的影响

Effect of moisture absorption on EPB15 bearings

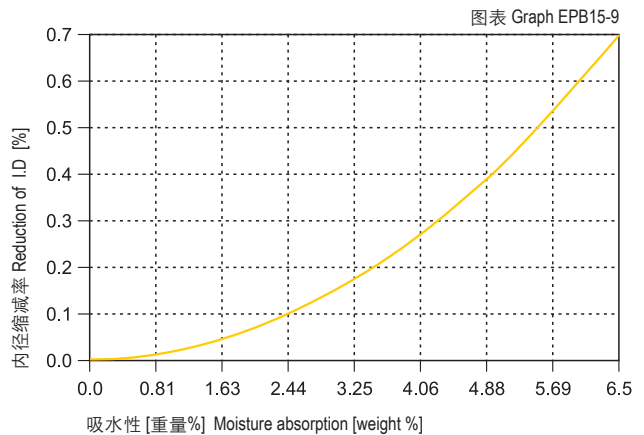



● 标准产品规格表 Standard specifications: P128

产品特性 Product features

- 高强度和低吸水率的耐磨材料。在潮湿环境中仍能保持良好的尺寸稳定性
- 连续使用温度: -40°C/+130°C
- 较高的载荷
- 适合干运行、免维护
- 吸水率较低
- 高载下性价比好
- Wear resistance material with high strength and low water absorption feature. The dimensions will remain stable even in humidity environment
- Continuous working temperature: -40°C/+130°C
- Higher load capacity
- Maintenance-free dry operation
- Low water absorption
- Good performance cost ratio under high load

材料数据表 Material properties data table

材料性能 Material properties	测试标准 Standard	单位 Unit	CSB-EPB16
颜色 Color	-	-	黑色 Black
密度 Density	ISO1183	g/cm ³	1.60
最大吸湿率 Max. moisture absorption, 50%RH	ISO62	%	0.2
最大吸水率 Max. water absorption	ISO62	%	0.4
对钢动摩擦系数 Coefficient of sliding friction(steel)	ITS025	μ	0.06-0.20
极限PV值 Max. PV value	ITS026	N/mm ² × m/s	0.40
弯曲模量 Flexural modulus	ISO178	MPa	4900
弯曲强度 Flexural strength	ISO178	MPa	140
最大静载荷 Max. static load	ITS027	MPa	75
最大动载荷 Max. dynamic load	ITS028	MPa	38
邵氏硬度 Shore hardness	ISO868	D	80
连续运行温度 Long-term application temperature	ITS029	°C	+130
短时运行温度 Short-term application temperature	ITS029	°C	+200
最低运行温度 Lowest application temperature	ITS029	°C	-40
导热性 Thermal conductivity	ISO22007	W/m/K	0.25
线性热膨胀系数 Coefficient of thermal expansion	ISO11359	K ⁻¹ × 10 ⁻⁵	4
阻燃等级 Flammability	UL94	Class	HB
体电阻率 Volume resistance	IEC60093	Ω · cm	>10 ¹³
面电阻率 Surface resistance	IEC60093	Ω	>10 ¹²

*ITS: CSB内部测试标准 CSB company's internal test standards.

**除非特殊说明测试温度为23°C Test temperatures are 23°C unless otherwise stated.

轴承PV值 PV value

CSB-EPB16塑料轴承最大运行PV值为0.4N/mm² × m/s; 由此决定轴承所承受的载荷与速度成反比, 详细查阅图表EPB16-1。

The max PV value of the CSB-EPB16 plastic bearings is 0.4N/mm² × m/s which determines the load capacity of bearing is inversely proportional to the speed. Please refer to the chart for more detailed information (Graph EPB16-1).

■ PV图表 Permissible PV value for CSB-EPB16

图表 Graph EPB16-1

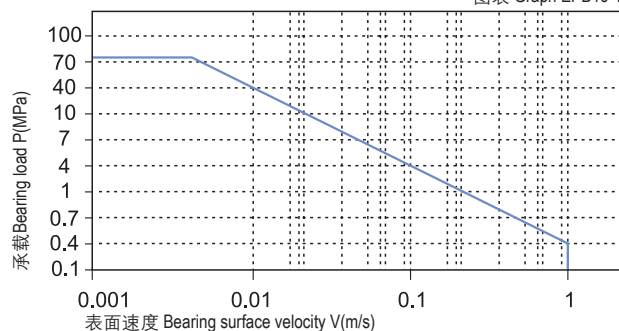

轴承的载荷、速度、温度 Load, speed and temperature

CSB-EPB16塑料轴承可承受最大静载荷为75Mpa，在此载荷下轴承的最大压缩变形量参考图表EPB16-2，轴承实际工作载荷略小于75Mpa，载荷还受到运行速度以及温度的影响，速度越快 (Vmax: 1.0m/s) 会导致摩擦温度上升，而温度上升 (Tmax: 130℃) 会导致轴承的承载能力逐渐减弱，载荷随轴承工作温度变化情况参考图表EPB16-3。

CSB-EPB16 allows the Max static load of 75Mpa, The max compressive deformation rate under the max load is listed in Graph EPB16-2, The actual load capacity of bearing is slightly less than 75Mpa, The bearing load is variable against the speed and temperature, Fast speed (Vmax: 1.0m/s) results into higher temperature (Tmax: 130℃) which decreases the load capacity of the bearing. Please refer to the Graph EPB16-3 for such variation.

轴承的摩擦系数、磨损、轴材料 Friction factor, wear and shaft material

摩擦系数 Friction factor

图表EPB16-4表明CSB-EPB16塑料轴承和大多数滑动轴承一样在载荷保持不变的情况下摩擦系数会随着旋转速度的增加略有升高；图表EPB16-5表明CSB-EPB16塑料轴承摩擦系数在速度保持不变的情况下随着载荷的增加而逐步降低；图表EPB16-6表明CSB-EPB16塑料轴承最适合的轴表面粗糙度为Ra0.1 ~ 0.2um，轴过于光滑或者过于粗糙都会导致摩擦系数升高。

Graph EPB16-4 shows that as the same as most of the slide bearing materials, the friction factor of CSB-EPB16 is increasing along with the rotation speed under a certain loading while as shown in Graph EPB16-5, it is decreased along with the increasing of loading when the operation speed is stable. From Graph EPB16-6, it is found that the most suitable shaft roughness is Ra0.1 to Ra0.2. Smoother shaft or rougher shaft may result into friction factor increasing.

摩擦系数与轴表面粗糙度关系图表

Coefficient of friction & the surface roughness of shaft

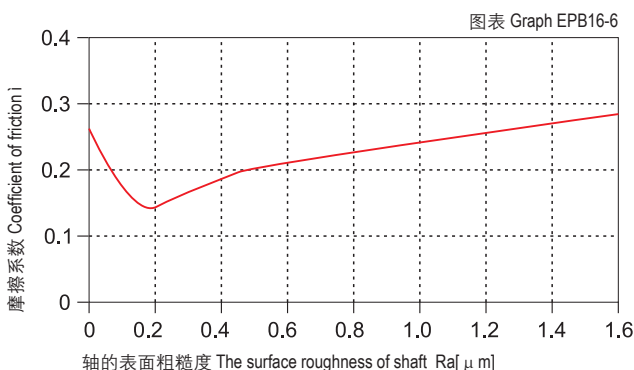

载荷-温度-变形量图表 Load-Temperature deformation

图表 Graph EPB16-2

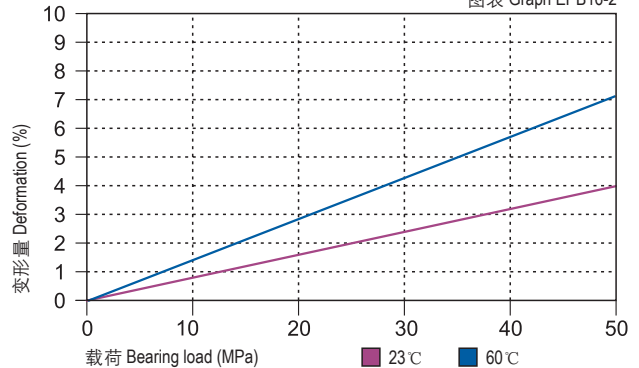

载荷-温度图表 Load-Temperature diagrams

图表 Graph EPB16-3

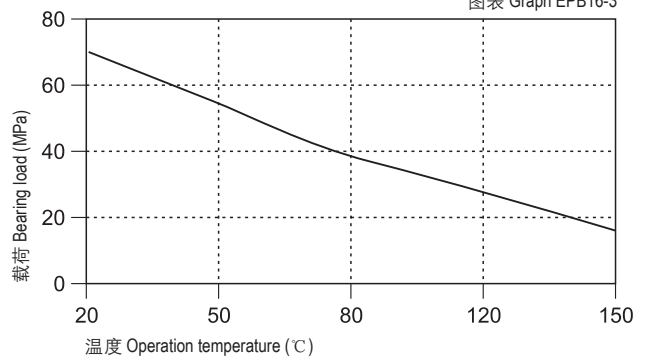

摩擦系数与速度变化关系图表 P=2MPa

Coefficient of friction & the speed of bearing, p = 2 MPa

图表 Graph EPB16-4

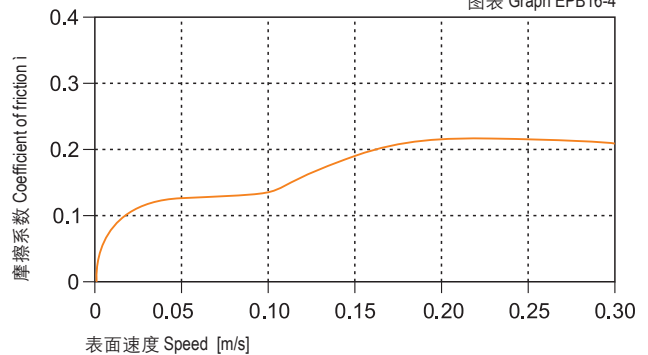

摩擦系数与载荷变化关系图表 v=0.2m/s

Coefficient of friction & the pressure of bearing, v = 0.2 m/s

图表 Graph EPB16-5

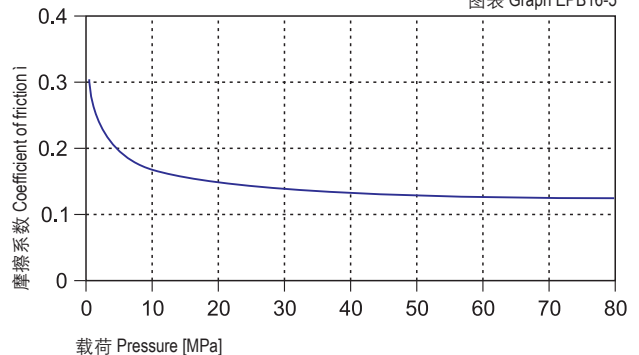

CSB-EPB16	干运行 Dry	油脂 Grease	油 Oil	水 Water
摩擦系数 μ Friction coef.	0.06-0.20	0.09	0.04	0.04

磨损与轴材料 Wearing and shaft material

图表EPB16-7与图表EPB16-8都表明CSB-EPB16塑料轴承的磨损受轴材料影响比较大，硬化钢轴和碳钢轴比较适合此轴承。CSB-EPB16塑料轴承在摆动运动时选择硬铬钢轴和硬化钢轴比较适合，而在旋转运动中则选择碳钢轴和硬化钢轴表交理想。

Graph EPB16-7 and Graph EPB16-8 shows the wearing is considerably affected by the shaft materials. Heat-treated steel shaft and carbon steel shaft is good for this bearing material. CSB-EPB16 is suitable for hardened chrome steel and hardened steel shaft in oscillation operation and is suitable for carbon steel and hardened steel shaft in rotation operation.

化学抗性 Chemical resistance

CSB-EPB16塑料轴承能抵抗部分弱酸以及各类润滑油的腐蚀。

CSB-EPB16 is good at chemical resistance against weak acidic medium and various kinds of lubricants.

吸水性 Water absorption

CSB-EPB16塑料轴承在标准大气中的吸湿率为0.2%。浸泡在水中的最高吸水率为0.4%。极低吸水率不会导致轴承发生性能和尺寸变化，非常适合用于潮湿环境。

The moisture absorption of CSB-EPB16 plastic plain bearings is 0.2% in standard atmosphere. The max. water absorption is 0.4% in water. These values are very low, CSB-EPB16 plastic plain bearings is very well suited for used in wet applications.

抗UV性能 UV resistance

CSB-EPB16塑料轴承长久暴露在紫外线下颜色会发生褪变。材料性能会有所下降。

Disintegration could be possible for the material CSB-EPB16 after long period of exposing under the UV ray and therefore the performance of the material will be reduced.

安装公差 Installation tolerances

CSB-EPB16塑料轴承压装后公差 Tolerances after pressfit

直径 Di [mm]	CSB-EPB16 E10 [mm]	座孔 Housing H7 [mm]	轴 Shaft h9 [mm]
>0 ~ 3	+0.014 ~ +0.054	0 ~ +0.010	0 ~ -0.025
>3 ~ 6	+0.020 ~ +0.068	0 ~ +0.012	0 ~ -0.030
>6 ~ 10	+0.025 ~ +0.083	0 ~ +0.015	0 ~ -0.036
>10 ~ 18	+0.032 ~ +0.102	0 ~ +0.018	0 ~ -0.043
>18 ~ 30	+0.040 ~ +0.124	0 ~ +0.021	0 ~ -0.052
>30 ~ 50	+0.050 ~ +0.150	0 ~ +0.025	0 ~ -0.062
>50 ~ 80	+0.060 ~ +0.180	0 ~ +0.030	0 ~ -0.074
>80 ~ 120	+0.072 ~ +0.212	0 ~ +0.035	0 ~ -0.087
>120 ~ 180	+0.085 ~ +0.245	0 ~ +0.040	0 ~ -0.100

在不同轴材料上旋转时的磨损量 $p=2\text{MPa}$, $v=0.2\text{m/s}$

Wear under rotating with different shaft materials, $p = 2 \text{ MPa}$, $v = 0.2 \text{ m/s}$

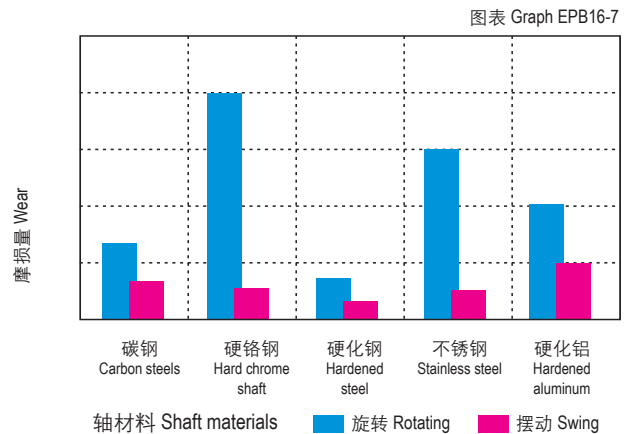

旋转磨损随轴材料与压力变化关系 $v=0.2\text{m/s}$

Wear & pressure under rotating with different shaft materials, $v = 0.2 \text{ m/s}$

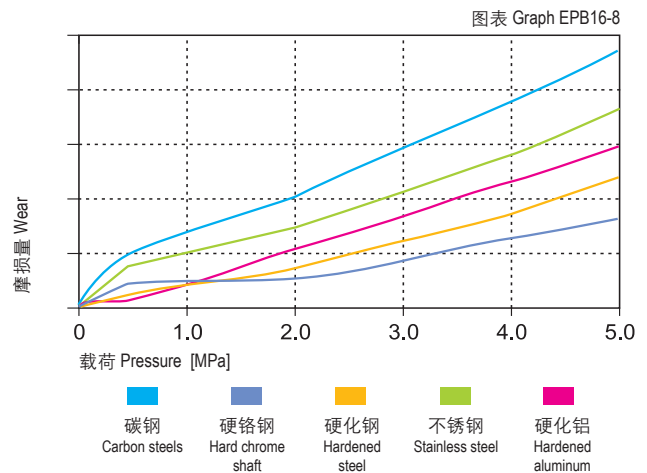

吸水性的影响

Effect of moisture absorption on EPB16 bearings

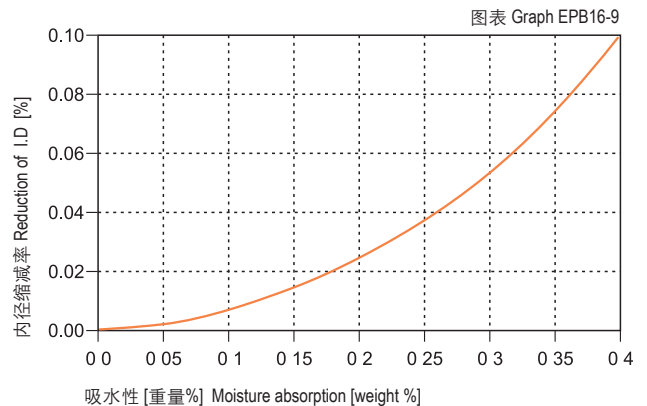



● 标准产品规格表 Standard specifications: P124

产品特性 Product features

- 低吸水性下的自润滑材料。在软轴和硬轴配合下耐磨性能同样出色
- 连续使用温度: -40°C/+100°C
- 适合干运行、免维护
- 适合高载荷运动
- 适合在潮湿环境中运行
- A self-lubricating material with low water absorption. Good wear resistance will be maintained when used with soft shaft and hard shaft combined
- Continuous working temperature: -40°C/+100°C
- Maintenance-free dry operation
- High load requirement
- Suitable for working in humid environment

材料数据表 Material properties data table

材料性能 Material properties	测试标准 Standard	单位 Unit	CSB-EPB18
颜色 Color	-	-	黄色 Yellow
密度 Density	ISO1183	g/cm ³	1.40
最大吸湿率 Max. moisture absorption, 50%RH	ISO62	%	0.3
最大吸水率 Max. water absorption	ISO62	%	0.5
对钢动摩擦系数 Coefficient of sliding friction(steel)	ITS025	μ	0.05-0.18
极限PV值 Max. PV value	ITS026	N/mm ² × m/s	0.40
弯曲模量 Flexural modulus	ISO178	MPa	2700
弯曲强度 Flexural strength	ISO178	MPa	65
最大静载荷 Max. static load	ITS027	MPa	50
最大动载荷 Max. dynamic load	ITS028	MPa	21
邵氏硬度 Shore hardness	ISO868	D	75
连续运行温度 Long-term application temperature	ITS029	°C	+100
短时运行温度 Short-term application temperature	ITS029	°C	+160
最低运行温度 Lowest application temperature	ITS029	°C	-40
导热性 Thermal conductivity	ISO22007	W/m/K	0.25
线性热膨胀系数 Coefficient of thermal expansion	ISO11359	K ⁻¹ × 10 ⁻⁵	8
阻燃等级 Flammability	UL94	Class	HB
体电阻率 Volume resistance	IEC60093	Ω · cm	>10 ¹²
面电阻率 Surface resistance	IEC60093	Ω	>10 ¹¹

*ITS: CSB内部测试标准 CSB company's internal test standards.

**除非特殊说明测试温度为23°C Test temperatures are 23°C unless otherwise stated.

轴承PV值 PV value

CSB-EPB18塑料轴承最大运行PV值为0.4N/mm² × m/s; 由此决定轴承所承受的载荷与速度成反比, 详细查阅图表EPB18-1。

The max PV value of the CSB-EPB18 plastic bearings is 0.4N/mm² × m/s which determines the load capacity of bearing is inversely proportional to the speed. Please refer to the chart for more detailed information (Graph EPB18-1).

■ PV图表 Permissible PV value for CSB-EPB18

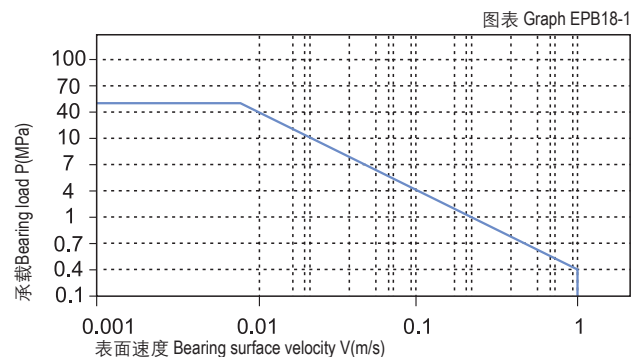

轴承的载荷、速度、温度 Load, speed and temperature

CSB-EPB18塑料轴承可承受最大静载荷为50Mpa，在此载荷下轴承的最大压缩变形量参考图表EPB18-2，轴承实际工作载荷略小于50Mpa，载荷还受到运行速度以及温度的影响，速度越快 (Vmax: 1.0m/s) 会导致摩擦温度上升，而温度上升 (Tmax: 100℃) 会导致轴承的承载能力逐渐减弱，载荷随轴承工作温度变化情况参考图表EPB18-3。

CSB-EPB18 allows the Max static load of 50Mpa, The max compressive deformation rate under the max load is listed in Graph EPB18-2, The actual load capacity of bearing is slightly less than 50Mpa, The bearing load is variable against the speed and temperature, Fast speed (Vmax: 1.0m/s) results into higher temperature (Tmax: 100℃) which decreases the load capacity of the bearing. Please refer to the Graph EPB18-3 for such variation.

轴承的摩擦系数、磨损、轴材料 Friction factor, wear and shaft material

摩擦系数 Friction factor

图EPB18-4表明CSB-EPB18塑料轴承和大多数滑动轴承一样在载荷保持不变的情况下摩擦系数会随着旋转速度的增加略有升高；图EPB18-5表明CSB-EPB18塑料轴承摩擦系数在速度保持不变的情况下随着载荷的增加而逐步降低；图EPB18-6表明CSB-EPB18塑料轴承最适合的轴表面粗糙度为Ra0.2 ~ 0.6 μ m，轴过于光滑或者过于粗糙都会导致摩擦系数升高。

Graph EPB18-4 shows that as the same as most of the slide bearing materials, the friction factor of CSB-EPB18 is increasing along with the rotation speed under a certain loading while as shown in figure EPB18-5, it is decreased along with the increasing of loading when the operation speed is stable. From figure EPB18-6, it is found that the most suitable shaft roughness is Ra0.2 to Ra0.6. Smoother shaft or rougher shaft may result into friction factor increasing.

■ 载荷-温度-变形量图表 Load-Temperature deformation

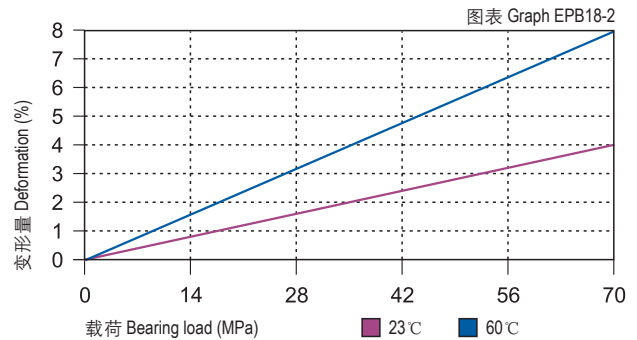

■ 载荷-温度图表 Load-Temperature diagrams

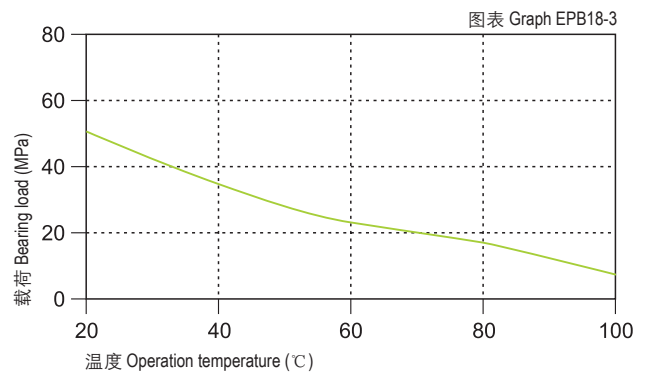

■ 摩擦系数与速度变化关系图表 P=2MPa Coefficient of friction & the speed of bearing, p = 2 MPa

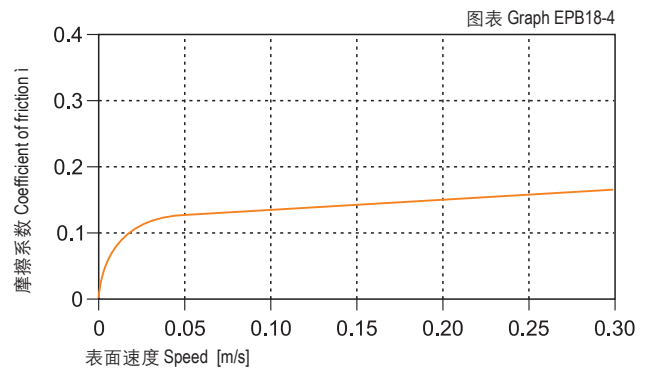

■ 摩擦系数与轴表面粗糙度关系图表

Coefficient of friction & the surface roughness of shaft

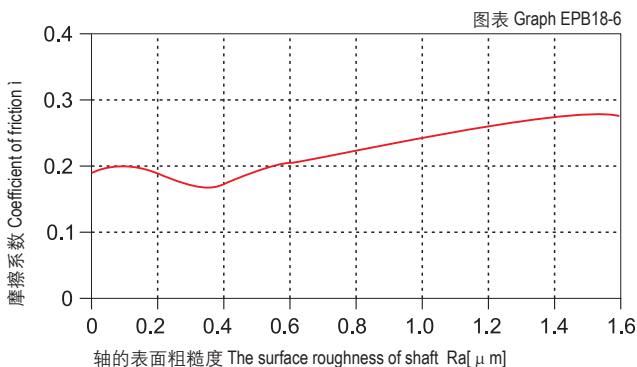

■ 摩擦系数与载荷变化关系图表 v=0.2m/s

Coefficient of friction & the pressure of bearing, v = 0.2 m/s

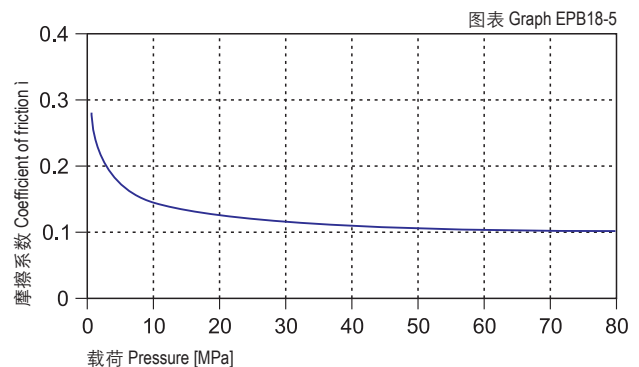

CSB-EPB18	干运行 Dry	油脂 Grease	油 Oil	水 Water
摩擦系数 μ Friction coef.	0.05-0.18	0.09	0.04	0.04

磨损与轴材料 Wearing and shaft material

图EPB18-7与图EPB18-8都表明CSB-EPB18塑料轴承的磨损受轴材料影响比较大，硬化钢轴和硬铬钢轴比较适合此轴承。图EPB18-7表明CSB-EPB18塑料轴承在旋转和摆动运动时选择硬铬钢轴和硬化钢轴比较适合。

Graph EPB18-7 and EPB18-8 shows the wearing is considerably affected by the shaft materials. Heat-treated steel shaft and carbon steel shaft is good for this bearing material. Graph EPB18-7 tells that CSB-EPB18 is suitable for hardened chrome steel and hardened steel shaft in rotation operation or oscillation operation.

化学抗性 Chemical resistance

CSB-EPB18塑料轴承能抵抗部分弱酸以及各类润滑油的腐蚀。

CSB-EPB18 is good at chemical resistance against weak acidic medium and various kinds of lubricants.

吸水性 Water absorption

CSB-EPB18塑料轴承在标准大气中的吸湿率为0.3%。浸泡在水中的最高吸水率为0.5%。极低吸水率不会导致轴承发生性能变化和尺寸变化，非常适合用于潮湿环境。

The moisture absorption of CSB-EPB18 plastic plain bearings is 0.3% in standard atmosphere. The max. water absorption is 0.5% in water. These values are very low, CSB-EPB18 plastic plain bearings is very well suited for used in wet applications.

抗UV性能 UV resistance

CSB-EPB18塑料轴承长久暴露在紫外线下颜色会发生褪变。材料性能会有所下降。

Disintegration could be possible for the material CSB-EPB18 after long period of exposing under the UV ray and therefore the performance of the material will be reduced.

安装公差 Installation tolerances

CSB-EPB18塑料轴承压装后公差 Tolerances after pressfit

直径 Di. [mm]	CSB-EPB18 E10 [mm]	座孔 Housing H7 [mm]	轴 Shaft h9 [mm]
>0 ~ 3	+0.014 ~ +0.054	0 ~ +0.010	0 ~ -0.025
>3 ~ 6	+0.020 ~ +0.068	0 ~ +0.012	0 ~ -0.030
>6 ~ 10	+0.025 ~ +0.083	0 ~ +0.015	0 ~ -0.036
>10 ~ 18	+0.032 ~ +0.102	0 ~ +0.018	0 ~ -0.043
>18 ~ 30	+0.040 ~ +0.124	0 ~ +0.021	0 ~ -0.052
>30 ~ 50	+0.050 ~ +0.150	0 ~ +0.025	0 ~ -0.062
>50 ~ 80	+0.060 ~ +0.180	0 ~ +0.030	0 ~ -0.074
>80 ~ 120	+0.072 ~ +0.212	0 ~ +0.035	0 ~ -0.087
>120 ~ 180	+0.085 ~ +0.245	0 ~ +0.040	0 ~ -0.100

在不同轴材料上旋转时的磨损量 $p=2\text{MPa}$, $v=0.2\text{m/s}$

Wear under rotating with different shaft materials, $p = 2 \text{ MPa}$, $v = 0.2 \text{ m/s}$

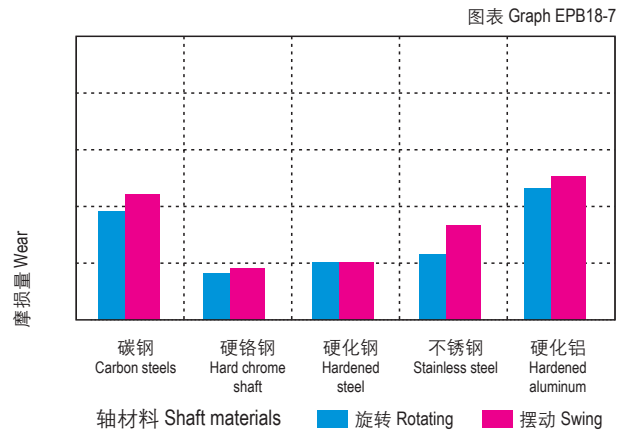

旋转磨损随轴材料与压力变化关系 $v=0.2\text{m/s}$

Wear & pressure under rotating with different shaft materials, $v = 0.2 \text{ m/s}$

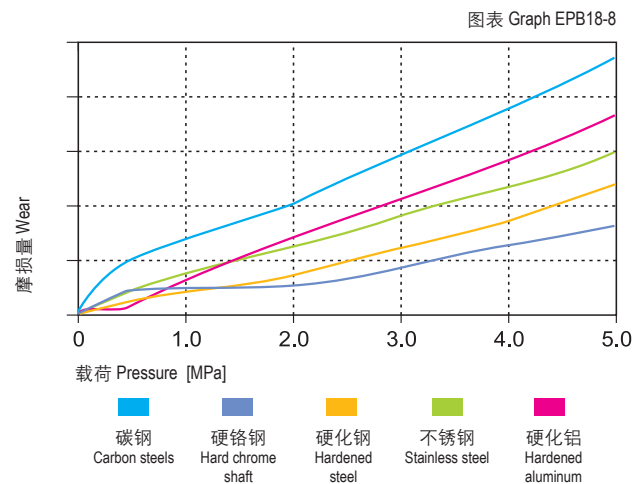

吸水性的影响

Effect of moisture absorption on EPB18 bearings

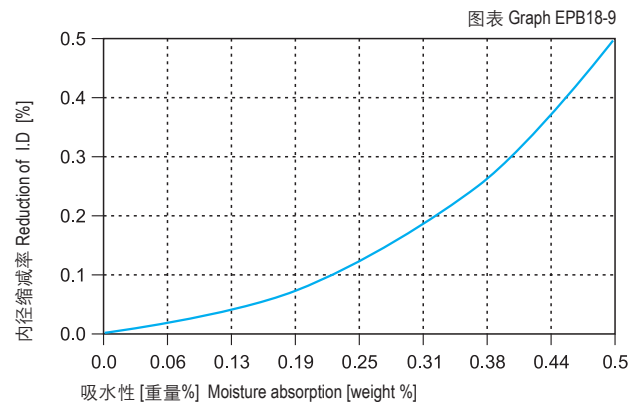



● 标准产品规格表 Standard specifications: P138

产品特性 Product features

- 高温150度下的耐磨材料。高低温下保持一致的自润滑材料
- 连续使用温度: -40°C/+150°C
- 适合高载下的摆动
- 适合干运行、免维护
- 较高的抗压强度
- Wear resistance material for temperature up to 150 °C. The Features of the material is kept stable either at high or low temperature
- Continuous working temperature: -40°C/+150°C
- Applicable for oscillating under high load
- Maintenance-free dry operation
- High pressure resistance

材料数据表 Material properties data table

材料性能 Material properties	测试标准 Standard	单位 Unit	CSB-EPB19
颜色 Color	-	-	深灰 Dark grey
密度 Density	ISO1183	g/cm ³	1.27
最大吸湿率 Max. moisture absorption, 50%RH	ISO62	%	1.3
最大吸水率 Max. water absorption	ISO62	%	4.5
对钢动摩擦系数 Coefficient of sliding friction(steel)	ITS025	μ	0.05-0.20
极限PV值 Max. PV value	ITS026	N/mm ² × m/s	0.60
弯曲模量 Flexural modulus	ISO178	MPa	2800
弯曲强度 Flexural strength	ISO178	MPa	80
最大静载荷 Max. static load	ITS027	MPa	60
最大动载荷 Max. dynamic load	ITS028	MPa	22
邵氏硬度 Shore hardness	ISO868	D	72
连续运行温度 Long-term application temperature	ITS029	°C	+150
短时运行温度 Short-term application temperature	ITS029	°C	+200
最低运行温度 Lowest application temperature	ITS029	°C	-40
导热性 Thermal conductivity	ISO22007	W/m/K	0.25
线性热膨胀系数 Coefficient of thermal expansion	ISO11359	K ⁻¹ × 10 ⁻⁵	10
阻燃等级 Flammability	UL94	Class	HB
体电阻率 Volume resistance	IEC60093	Ω · cm	>10 ¹³
面电阻率 Surface resistance	IEC60093	Ω	>10 ¹¹

*ITS: CSB内部测试标准 CSB company's internal test standards.

**除非特殊说明测试温度为23°C Test temperatures are 23 °C unless otherwise stated.

轴承PV值 PV value

CSB-EPB19塑料轴承最大运行PV值为0.6N/mm² × m/s; 由此决定轴承所承受的载荷与速度成反比, 详细查阅EPB19-1。

The max PV value of the CSB-EPB19 plastic bearings is 0.6N/mm² × m/s which determines the load capacity of bearing is inversely proportional to the speed. Please refer to the chart for more detailed information (Graph EPB19-1).

■ PV图表 Permissible PV value for CSB-EPB19

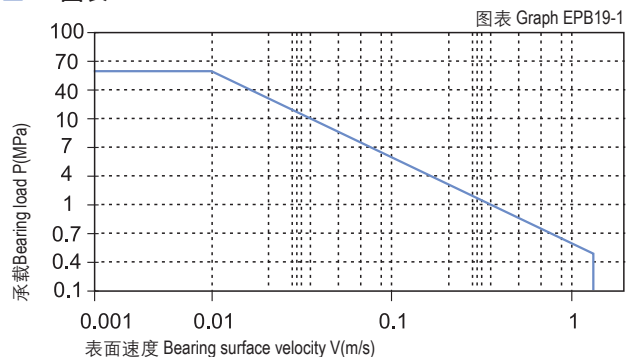

轴承的载荷、速度、温度 Load, speed and temperature

CSB-EPB19塑料轴承可承受最大静载荷为60Mpa，在此载荷下轴承的最大压缩变形量参考EPB19-2，轴承实际工作载荷略小于60Mpa，载荷还受到运行速度以及温度的影响，速度越快 (Vmax: 1.5m/s) 会导致摩擦温度上升，而温度上升 (Tmax: 150℃) 会导致轴承的承载能力逐渐减弱，载荷随轴承工作温度变化情况参考EPB19-3。

CSB-EPB19 allows the Max static load of 60Mpa, The max compressive deformation rate under the max load is listed in Graph EPB19-2, The actual load capacity of bearing is slightly less than 60Mpa, The bearing load is variable against the speed and temperature, Fast speed (Vmax: 1.5m/s) results into higher temperature (Tmax: 150℃) which decreases the load capacity of the bearing. Please refer to the Graph EPB19-3 for such variation.

轴承的摩擦系数、磨损、轴材料 Friction factor, wear and shaft material

摩擦系数 Friction factor

图表EPB19-4表明CSB-EPB19塑料轴承的摩擦系数随着运动速度的变化影响较小，而图表EPB19-5表明CSB-EPB19塑料轴承的摩擦系数随着载荷的增加明显减小，在载荷超过20Mpa是逐渐趋于平稳；图表EPB19-6表明CSB-EPB19塑料轴承的摩擦系数受轴粗糙度的影响也相对比较小；虽然如此，我们还是建议轴的表面不能太光滑，也不能过于出差，推荐使用轴的粗糙度为Ra0.3~0.6um；

Graph EPB19-4 shows that the friction factor of CSB-EPB19 is not sensitive to the operation speed. Graph EPB19-5 tells that the friction factor of CSB-EPB19 is decreased along with the loading increasing and will be relatively stable when the loading reaches 20 Mpa upwards. Graph EPB19-6 shows that the friction factor of CSB-EPB19 is not sensitive to the shaft surface roughness. Therefore, it is recommended a proper shaft surface roughness in the range of Ra0.3~0.6.

摩擦系数与轴表面粗糙度关系图表

Coefficient of friction & the surface roughness of shaft

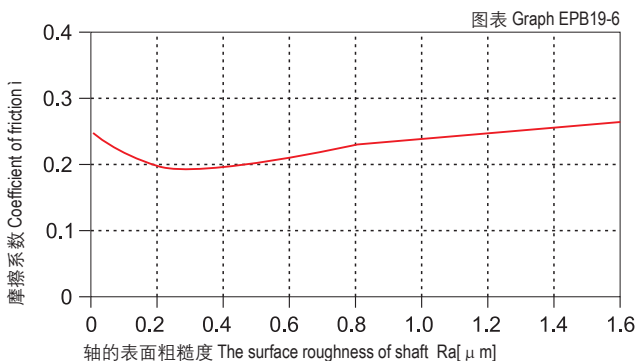

载荷-温度-变形量图表 Load-Temperature deformation

图表 Graph EPB19-2

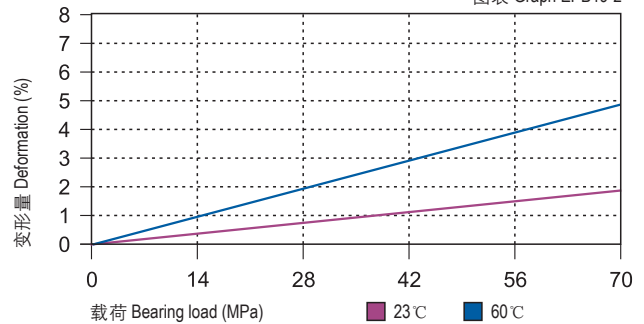

载荷-温度图表 Load-Temperature diagrams

图表 Graph EPB19-3

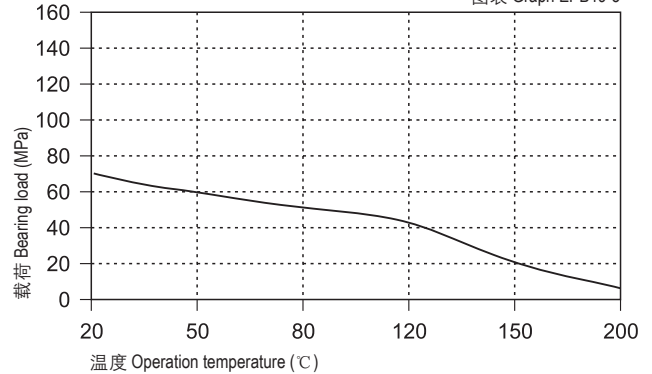

摩擦系数与速度变化关系图表 P=2MPa

Coefficient of friction & the speed of bearing, p = 2 MPa

图表 Graph EPB19-4

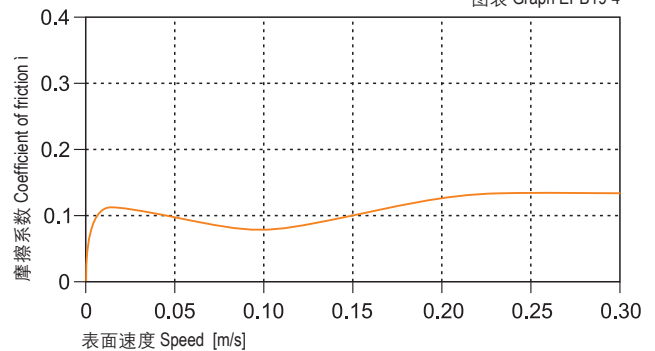

摩擦系数与载荷变化关系图表 v=0.2m/s

Coefficient of friction & the pressure of bearing, v = 0.2 m/s

图表 Graph EPB19-5

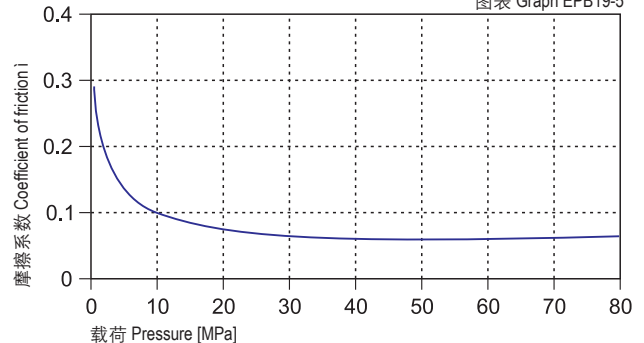

CSB-EPB19	干运行 Dry	油脂 Grease	油 Oil	水 Water
摩擦系数 μ Friction coef.	0.05~0.20	0.09	0.04	0.04

磨损与轴材料 Wearing and shaft material

图表EPB19-7表明CSB-EPB19塑料轴承在2Mpa下做旋转运动时，磨损随着轴材料的变化较大；通过实验表明CSB-EPB19塑料轴承在做旋转运动时比较适合用于硬轴，高速钢轴和硬铬轴上用于CSB-EPB19塑料轴承能获得良好的运行效果。图表EPB19-8表明硬铬轴更适合用于高载荷下的CSB-EPB19塑料轴承，随着载荷的不断增加，轴承的磨损速率却变化较小。

Graph EPB19-7 shows CSB-EPB19 friction factor is variable against different shaft materials in rotation operation under loading of 2Mpa. Testing indicates that hardened shaft is best for rotation operation of CSB-EPB19. The operation condition is better when CSB-EPB19 is used against hardened steel shafts, high speed steel shaft and hardened chrome steel shaft under rotation operation. Graph EPB19-8x describes that hardened chrome steel is better for this material under high loading operation where as long as the increasing of the loading, the wearing of the bearing is relatively stable.

化学抗性 Chemical resistance

CSB-EPB19塑料轴承能抵抗弱碱、弱酸以及各类润滑油的腐蚀。

CSB-EPB19 is good at chemical resistance against mild base, weak acidic medium and various kinds of lubricants.

吸水性 Water absorption

CSB-EPB19塑料轴承在标准大气中的吸湿率为1.3%。浸泡在水中最高吸水率为4.5%。由于高吸水率的特性，我们必须考虑此轴承的应用环境。

The moisture absorption of CSB-EPB19 plastic plain bearings is 1.3% in standard atmosphere. The max. water absorption is 4.5% in water. The application environment has to be considered due to the high water absorption properties.

抗UV性能 UV resistance

CSB-EPB19塑料轴承长久暴露在紫外线下颜色会发生褪变。材料性能基本都不会发生改变。

The color of CSB-EPB19 could be dimmed when it is exposed into the UV ray. The material performance stays stable.

安装公差 Installation tolerances

CSB-EPB19塑料轴承压装后公差 Tolerances after pressfit

直径 Di. [mm]	CSB-EPB19 E10 [mm]	座孔 Housing H7 [mm]	轴 Shaft h9 [mm]
>0 ~ 3	+0.014 ~ +0.054	0 ~ +0.010	0 ~ -0.025
>3 ~ 6	+0.020 ~ +0.068	0 ~ +0.012	0 ~ -0.030
>6 ~ 10	+0.025 ~ +0.083	0 ~ +0.015	0 ~ -0.036
>10 ~ 18	+0.032 ~ +0.102	0 ~ +0.018	0 ~ -0.043

在不同轴材料上旋转时的磨损量 $p=2\text{MPa}$, $v=0.2\text{m/s}$

Wear under rotating with different shaft materials, $p = 2 \text{ MPa}$, $v = 0.2 \text{ m/s}$

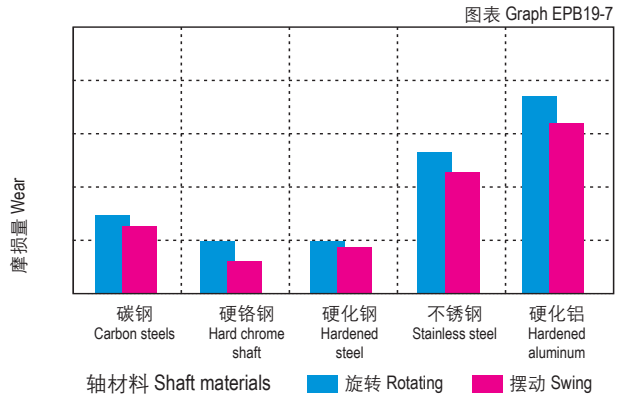

旋转磨损随轴材料与压力变化关系 $v=0.2\text{m/s}$

Wear & pressure under rotating with different shaft materials, $v = 0.2 \text{ m/s}$

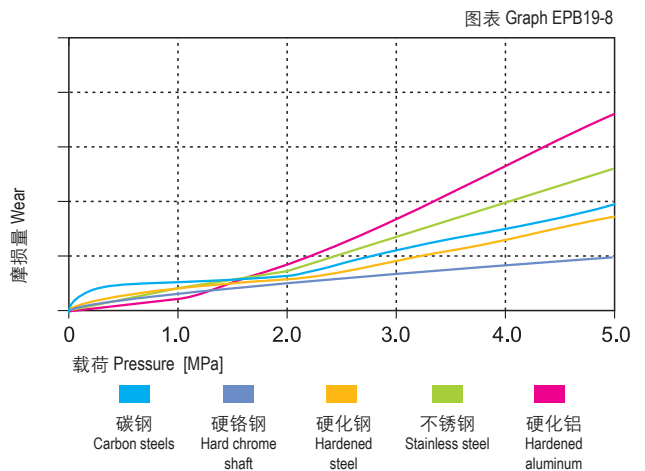

吸水性的影响 Effect of moisture absorption on EPB19 bearings

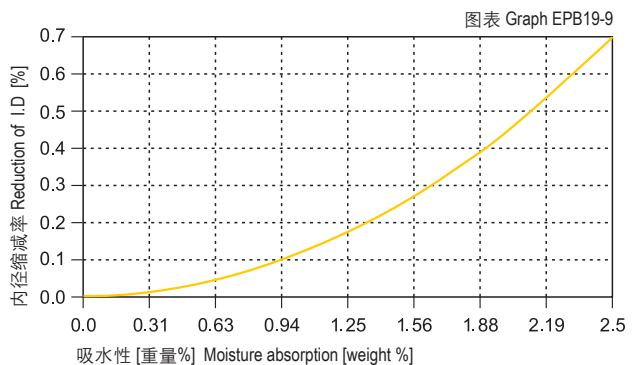

直径 Di. [mm]	CSB-EPB19 E10 [mm]	座孔 Housing H7 [mm]	轴 Shaft h9 [mm]
>18 ~ 30	+0.040 ~ +0.124	0 ~ +0.021	0 ~ -0.052
>30 ~ 50	+0.050 ~ +0.150	0 ~ +0.025	0 ~ -0.062
>50 ~ 80	+0.060 ~ +0.180	0 ~ +0.030	0 ~ -0.074
>80 ~ 120	+0.072 ~ +0.212	0 ~ +0.035	0 ~ -0.087
>120 ~ 180	+0.085 ~ +0.245	0 ~ +0.040	0 ~ -0.100

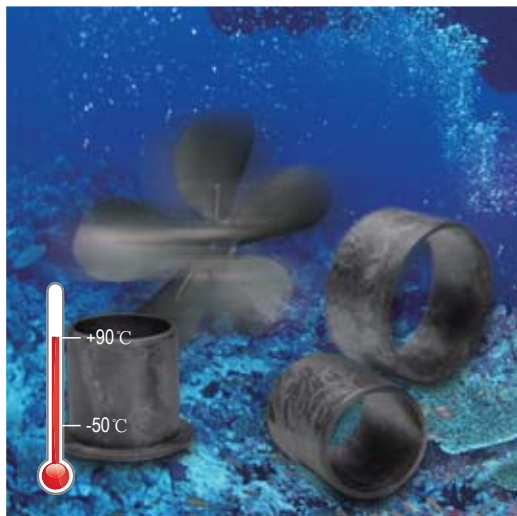

● 标准产品规格表 Standard specifications: P128

产品特性 Product features

- 用于水下的自润滑材料。适合在水中做低载荷下的快速旋转运动
- 连续使用温度: -50℃/+90℃
- 适用于中低载荷
- 适用于水下
- 高速场合应用
- A self-lubricating material for applications in water. It is suitable for high speed motion under low load
- Continuous working temperature: -50℃/+90℃
- Suitable for medium load operation
- For underwater operation
- For high speed movement

材料数据表 Material properties data table

材料性能 Material properties	测试标准 Standard	单位 Unit	CSB-EPB20
颜色 Color	-	-	黑色 Black
密度 Density	ISO1183	g/cm ³	1.53
最大吸湿率 Max. moisture absorption, 50%RH	ISO62	%	0.2
最大吸水率 Max. water absorption	ISO62	%	0.8
对钢动摩擦系数 Coefficient of sliding friction(steel)	ITS025	μ	0.15-0.35
极限PV值 Max. PV value	ITS026	N/mm ² × m/s	0.15
弯曲模量 Flexural modulus	ISO178	MPa	7200
弯曲强度 Flexural strength	ISO178	MPa	120
最大静载荷 Max. static load	ITS027	MPa	70
最大动载荷 Max. dynamic load	ITS028	MPa	35
邵氏硬度 Shore hardness	ISO868	D	79
连续运行温度 Long-term application temperature	ITS029	℃	+90
短时运行温度 Short-term application temperature	ITS029	℃	+110
最低运行温度 Lowest application temperature	ITS029	℃	-50
导热性 Thermal conductivity	ISO22007	W/m/K	0.60
线性热膨胀系数 Coefficient of thermal expansion	ISO11359	K ⁻¹ × 10 ⁻⁵	6
阻燃等级 Flammability	UL94	Class	HB
体电阻率 Volume resistance	IEC60093	Ω · cm	<10 ⁵
面电阻率 Surface resistance	IEC60093	Ω	<10 ⁵

*ITS: CSB内部测试标准 CSB company's internal test standards.

**除非特殊说明测试温度为23℃ Test temperatures are 23℃ unless otherwise stated.

轴承PV值 PV value

CSB-EPB20塑料轴承最大运行PV值为0.15N/mm² × m/s; 由此决定轴承所承受的载荷与速度成反比, 详细查阅图表EPB20-1。

The max PV value of the CSB-EPB20 plastic bearings is 0.15N/mm² × m/s which determines the load capacity of bearing is inversely proportional to the speed. Please refer to the chart for more detailed information (Graph EPB20-1).

■ PV图表 Permissible PV value for CSB-EPB20

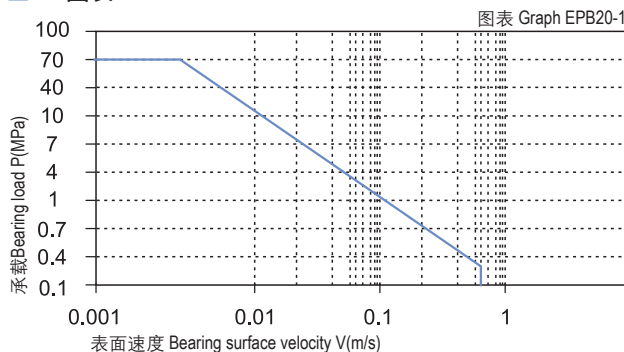

轴承的载荷、速度、温度 Load, speed and temperature

CSB-EPB20塑料轴承可承受最大静载荷为70Mpa，在此载荷下轴承的最大压缩变形量参考图表EPB20-2，轴承实际工作载荷略小于70Mpa，载荷还受到运行速度以及温度的影响，速度越快 (Vmax: 0.5m/s) 会导致摩擦温度上升，而温度上升 (Tmax: 90℃) 会导致轴承的承载能力逐渐减弱，载荷随轴承工作温度变化情况参考图表EPB20-3。

CSB-EPB20 allows the Max static load of 70Mpa, The max compressive deformation rate under the max load is listed in Graph EPB20-2, The actual load capacity of bearing is slightly less than 70Mpa, The bearing load is variable against the speed and temperature, Fast speed (Vmax: 0.5m/s) results into higher temperature (Tmax: 90℃) which decreases the load capacity of the bearing. Please refer to the Graph EPB20-3 for such variation.

轴承的摩擦系数、磨损、轴材料 Friction factor, wear and shaft material

摩擦系数 Friction factor

与其它塑料轴承基本一样，图EPB20-4表明CSB-EPB20塑料轴承在载荷保持不变的情况下摩擦系数随着运行速度的增加而升高；图EPB20-5表明CSB-EPB20塑料轴承在保持速度不变时摩擦系数随着载荷的增加而逐步减低。根据图EPB20-6表明CSB-EPB20塑料轴承的摩擦系数会随着轴表面粗糙度的变化而不同，我们推荐使用轴粗糙度为Ra0.3~0.6um；

Similar with most of the plastic bearings, the friction factor of CSB-EPB20 is increased along with the operation speed when the loading is stable (see Graph EPB20-4) and is decreased along with the loading increasing when the operation speed is stable (see Graph EPB20-5). From Graph EPB20-6, it shows the friction factor of CSB-EPB20 is variable against different shaft surface roughness. The recommended shaft surface roughness is Ra0.3~0.6.

摩擦系数与轴表面粗糙度关系图表

Coefficient of friction & the surface roughness of shaft

图表 Graph EPB20-6

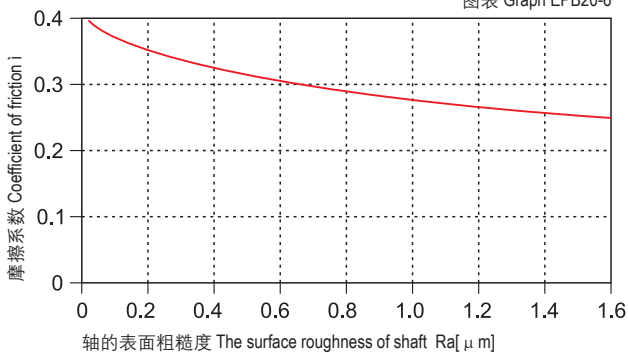

载荷-温度-变形量图表 Load-Temperature deformation

图表 Graph EPB20-2

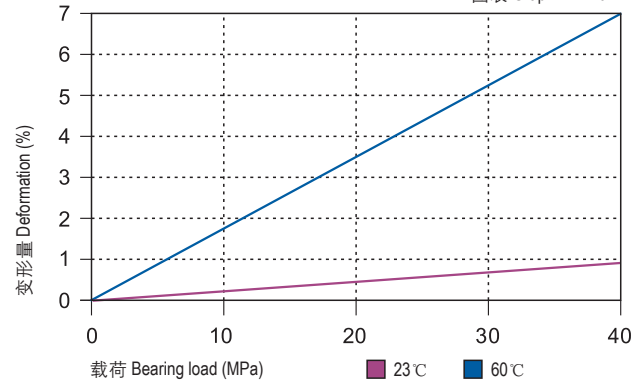

载荷-温度图表 Load-Temperature diagrams

图表 Graph EPB20-3

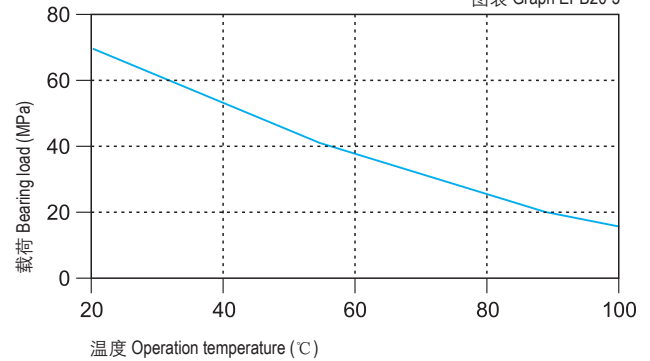

摩擦系数与速度变化关系图表 P=2MPa

Coefficient of friction & the speed of bearing, p = 2 MPa

图表 Graph EPB20-4

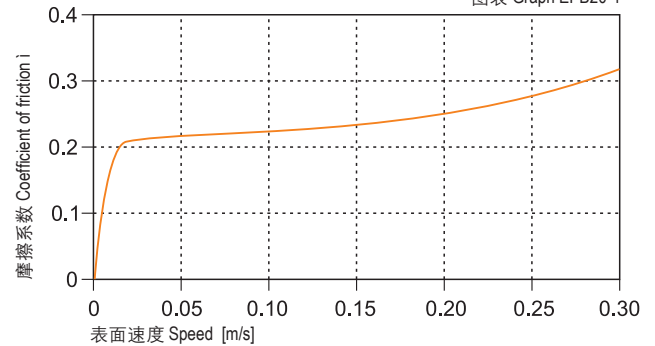

摩擦系数与载荷变化关系图表 v=0.2m/s

Coefficient of friction & the pressure of bearing, v = 0.2 m/s

图表 Graph EPB20-5

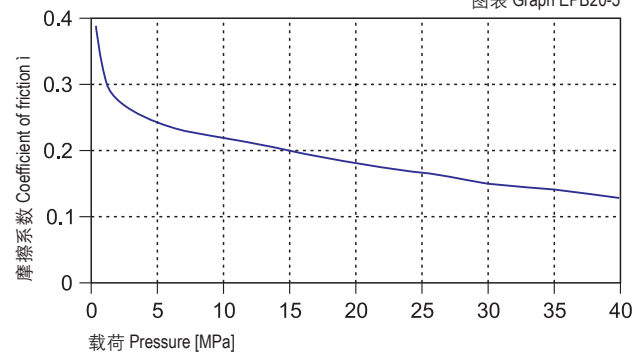

CSB-EPB2	干运行 Dry	油脂 Grease	油 Oil	水 Water
摩擦系数 μ Friction coef.	0.15~0.35	0.09	0.04	0.04

磨损与轴材料 Wearing and shaft material

图EPB20-7与图EPB20-8表明低载时硬化钢轴与硬铬钢轴比较适合用于CSB-EPB20塑料轴承。图EPB20-7表明CSB-EPB20塑料轴承在用于摆动运动时磨损值明显要优越于用于旋转运动。

Graph EPB20-7 and EPB20-8 shows that CSB-EPB20 is rather suitable for hardened steel shaft and hardened chrome steel shaft under lower loading and Graph EPB20-7 shows that CSB-EPB20 wearing feature is better for oscillation operation than of rotation operation.

化学抗性 Chemical resistance

CSB-EPB20塑料轴承能抵抗部分弱酸以及各类润滑油的腐蚀。

CSB-EPB20 is good at chemical resistance against weak acidic medium and various kinds of lubricants.

吸水性 Water absorption

CSB-EPB20塑料轴承在标准大气中的吸湿率为0.2%。浸泡在水中的最高吸水率为0.8%。低吸水性不会导致轴承发生性能和尺寸变化，非常适合用于水下。

The moisture absorption of CSB-EPB20 plastic plain bearings is 0.2% in standard atmosphere. The max. water absorption is 0.8% in water. These values are very low, CSB-EPB20 plastic plain bearings is very well suited for used in water.

抗UV性能 UV resistance

CSB-EPB20塑料轴承长久暴露在紫外线下颜色会发生褪变。材料性能会有所下降。

Disintegration could be possible for the material CSB-EPB20 after long period of exposing under the UV ray and therefore the performance of the material will be reduced.

安装公差 Installation tolerances

CSB-EPB20塑料轴承压装后公差 Tolerances after pressfit

直径 Di. [mm]	CSB-EPB20 E10 [mm]	座孔 Housing H7 [mm]	轴 Shaft h9 [mm]
>0 ~ 3	+0.014 ~ +0.054	0 ~ +0.010	0 ~ -0.025
>3 ~ 6	+0.020 ~ +0.068	0 ~ +0.012	0 ~ -0.030
>6 ~ 10	+0.025 ~ +0.083	0 ~ +0.015	0 ~ -0.036
>10 ~ 18	+0.032 ~ +0.102	0 ~ +0.018	0 ~ -0.043
>18 ~ 30	+0.040 ~ +0.124	0 ~ +0.021	0 ~ -0.052
>30 ~ 50	+0.050 ~ +0.150	0 ~ +0.025	0 ~ -0.062
>50 ~ 80	+0.060 ~ +0.180	0 ~ +0.030	0 ~ -0.074
>80 ~ 120	+0.072 ~ +0.212	0 ~ +0.035	0 ~ -0.087
>120 ~ 180	+0.085 ~ +0.245	0 ~ +0.040	0 ~ -0.100

在不同轴材料上旋转时的磨损量 $p=2\text{MPa}$, $v=0.2\text{m/s}$

Wear under rotating with different shaft materials, $p = 2 \text{ MPa}$, $v = 0.2 \text{ m/s}$

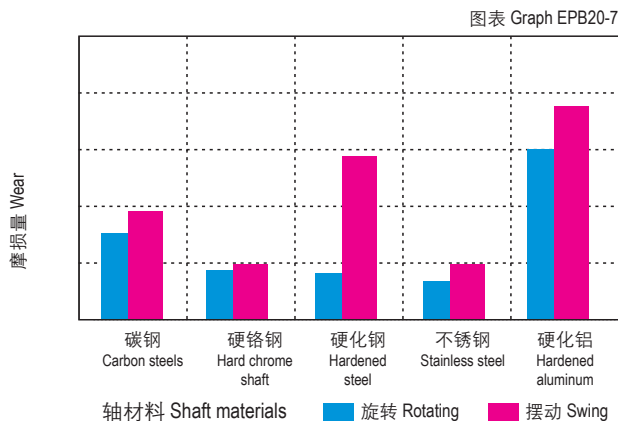

旋转磨损随轴材料与压力变化关系 $v=0.2\text{m/s}$

Wear & pressure under rotating with different shaft materials, $v = 0.2 \text{ m/s}$

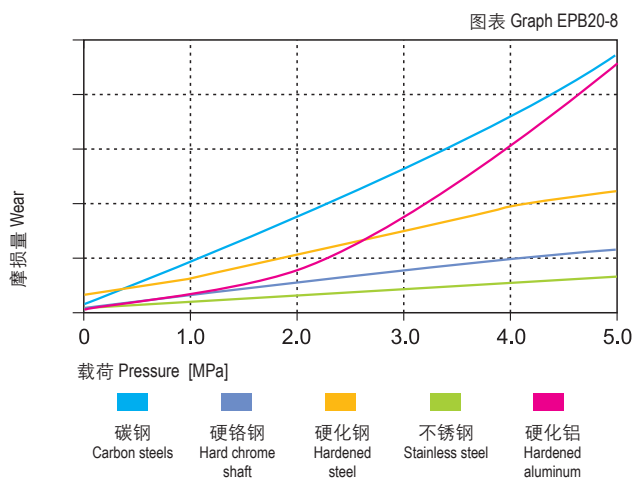

吸水性的影响

Effect of moisture absorption on EPB20 bearings

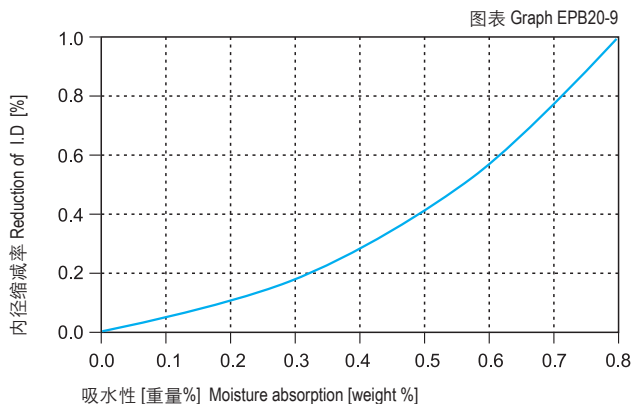



● 标准产品规格表 Standard specifications: P128

产品特性 Product features

- 高温下的低摩擦系数和耐磨性同样出色材料。抗化学腐蚀优良。被用于高温、高化学抗性要求下耐磨轴承的优选材料
- 连续使用温度: -40°C/+200°C
- 非常低的摩擦系数
- 适合干运行、免维护
- 高温和良好的化学抗性
- 适合潮湿环境中使用
- Low friction and good wear resistance for high temperature applications. The excellent chemical resistance of the material ensures the applications for high temperature and high chemical erosion applications
- Continuous working temperature: -40°C/+200°C
- Very low coefficient of friction
- Maintenance-free dry operation
- High temperature and good chemical resistance
- Suitable for humid environment

材料数据表 Material properties data table

材料性能 Material properties	测试标准 Standard	单位 Unit	CSB-EPB21
颜色 Color	-	-	米色 Beige
密度 Density	ISO1183	g/cm ³	1.53
最大吸湿率 Max. moisture absorption, 50%RH	ISO62	%	0.1
最大吸水率 Max. water absorption	ISO62	%	0.3
对钢动摩擦系数 Coefficient of sliding friction(steel)	ITS025	μ	0.05-0.20
极限PV值 Max. PV value	ITS026	N/mm ² × m/s	0.80
弯曲模量 Flexural modulus	ISO178	MPa	2800
弯曲强度 Flexural strength	ISO178	MPa	55
最大静载荷 Max. static load	ITS027	MPa	80
最大动载荷 Max. dynamic load	ITS028	MPa	37
邵氏硬度 Shore hardness	ISO868	D	77
连续运行温度 Long-term application temperature	ITS029	°C	+200
短时运行温度 Short-term application temperature	ITS029	°C	+240
最低运行温度 Lowest application temperature	ITS029	°C	-40
导热性 Thermal conductivity	ISO22007	W/m/K	0.24
线性热膨胀系数 Coefficient of thermal expansion	ISO11359	K ⁻¹ × 10 ⁻⁵	6
阻燃等级 Flammability	UL94	Class	V0
体电阻率 Volume resistance	IEC60093	Ω · cm	>10 ¹²
面电阻率 Surface resistance	IEC60093	Ω	>10 ¹¹

*ITS: CSB内部测试标准 CSB company's internal test standards.

**除非特殊说明测试温度为23°C Test temperatures are 23°C unless otherwise stated.

轴承PV值 PV value

CSB-EPB21塑料轴承最大运行PV值0.8N/mm² × m/s; 由此决定轴承所承受的载荷与速度成反比, 详细查阅图表EPB21-1。

The max PV value of the CSB-EPB21 plastic bearings is 0.8N/mm² × m/s which determines the load capacity of bearing is inversely proportional to the speed. Please refer to the chart for more detailed information (Graph EPB21-1).

PV图表 Permissible PV value for CSB-EPB21

图表 Graph EPB21-1

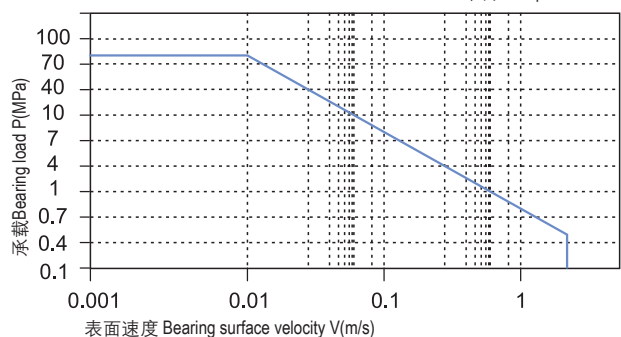

轴承的载荷、速度、温度 Load, speed and temperature

CSB-EPB21塑料轴承可承受最大静载荷为80Mpa，在此载荷下轴承的最大压缩变形量参考图表EPB21-2，轴承实际工作载荷略小于80Mpa，载荷还受到运行速度以及温度的影响，速度越快 (Vmax: 1.5m/s) 会导致摩擦温度上升，而温度上升 (Tmax: 200℃) 会导致轴承的承载能力逐渐减弱，载荷随轴承工作温度变化情况参考图表EPB21-3。

CSB-EPB21 allows the Max static load of 80Mpa, The max compressive deformation rate under the max load is listed in Graph EPB21-2, The actual load capacity of bearing is slightly less than 80Mpa, The bearing load is variable against the speed and temperature, Fast speed (Vmax: 1.5m/s) results into higher temperature (Tmax: 200℃) which decreases the load capacity of the bearing. Please refer to the Graph EPB21-3 for such variation.

轴承的摩擦系数、磨损、轴材料 Friction factor, wear and shaft material

摩擦系数 Friction factor

图表EPB21-4表明CSB-EPB21塑料轴承在载荷保持不定时旋转下的摩擦系数会随着速度的增加而略有减低；图表EPB21-5表明CSB-EPB21塑料轴承在速度保持不定时旋转下的摩擦系数会随着载荷的增加而逐步降低，特别是在载荷小于30Mpa的情况下。图表EPB21-6表明CSB-EPB21塑料轴承的对磨轴粗糙度在Ra0.3 ~ 0.4um时摩擦系数几乎没有变化，但当轴表面粗糙度大于Ra0.4时摩擦系数会快速上升；我们推荐使用轴的粗糙度为Ra0.3 ~ 0.4um。

Friction factor will be slightly decreased along with the speed increasing under certain loading of the rotation operation (see Graph EPB21-4) and it will be slightly decreased along with the loading increasing under certain speed of the rotation operation especially when the loading is less than 30Mpa. Graph EPB21-5 tells that the friction of the CSB-EPB21 is not changed at all when the shaft roughness is between Ra0.3 to Ra0.4 and will be considerably increased when the shaft roughness is over Ra0.4. So the recommended shaft roughness is Ra0.3-Ra0.4.

摩擦系数与轴表面粗糙度关系图表

Coefficient of friction & the surface roughness of shaft

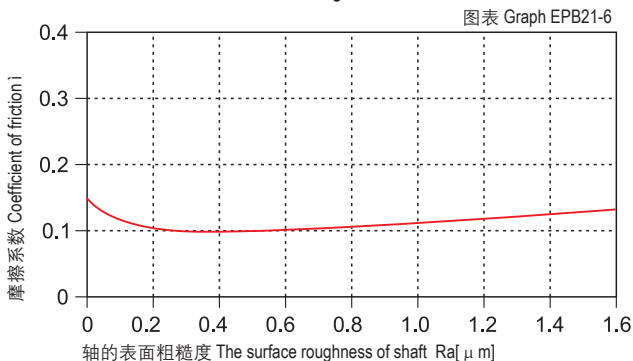

载荷-温度-变形量图表 Load-Temperature deformation

图表 Graph EPB21-2

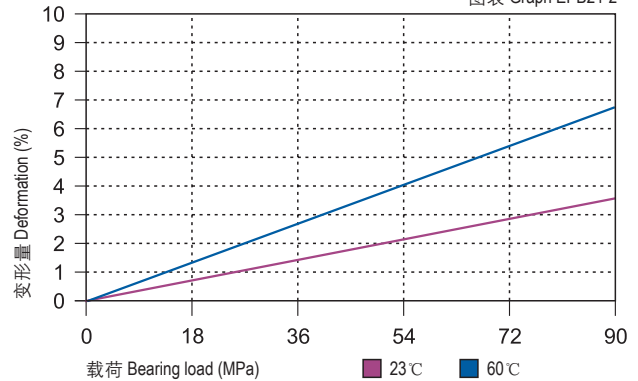

载荷-温度图表 Load-Temperature diagrams

图表 Graph EPB21-3

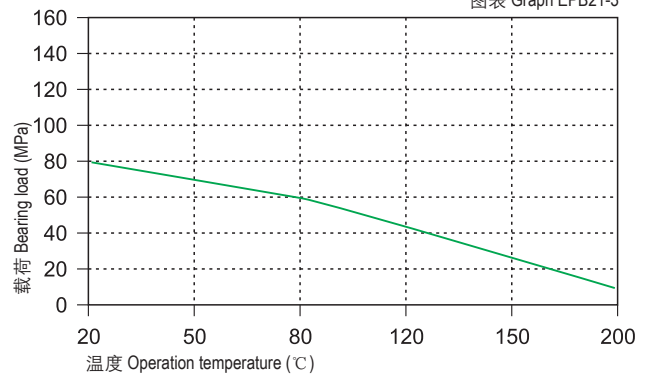

摩擦系数与速度变化关系图表 P=2MPa

Coefficient of friction & the speed of bearing, p = 2 MPa

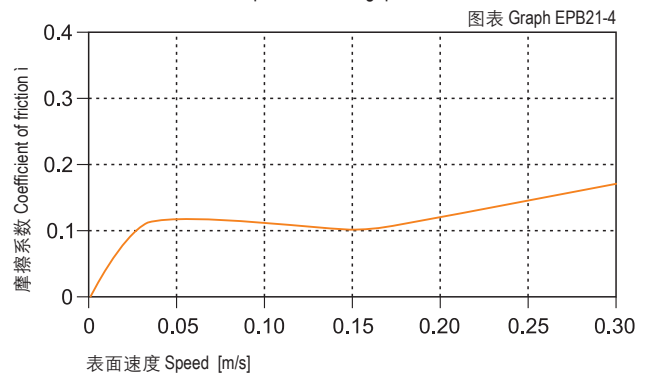

摩擦系数与载荷变化关系图表 v=0.2m/s

Coefficient of friction & the pressure of bearing, v = 0.2 m/s

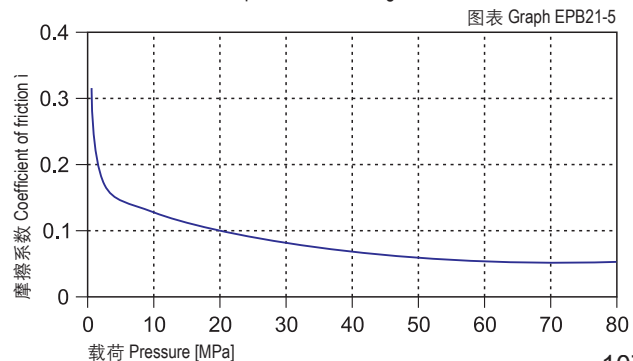

CSB-EPB21	干运行 Dry	油脂 Grease	油 Oil	水 Water
摩擦系数 μ Friction coef.	0.05-0.20	0.09	0.04	0.04

磨损与轴材料 Wearing and shaft material

图表EPB21-7与EPB21-8表明CSB-EPB21塑料轴承在旋转运动时适合大都数轴材料，而在高载旋转下不锈钢轴表现尤为特出（见图表EPB21-8）；CSB-EPB21塑料轴承比较适合用于摆动运动，在旋转运动中不锈钢和硬化铝轴效果比较好。

Graph EPB21-7 and EPB21-8 shows that CSB-EPB21 is suitable for most of the shaft materials under rotation operation and it is good for stainless steel shaft under high loading rotation operation (see Graph EPB21-8). CSB-EPB21 is suitable for oscillation operation, Stainless steel shaft and hardened aluminum shaft is suitable for the bearing under rotation operation.

化学抗性 Chemical resistance

CSB-EPB21塑料轴承具有很好的化学抗性，能抵抗绝大多数酸碱。

The Chemical Resistance of CSB-EPB21 is fairly good against most of Acid and Alkalis.

吸水性 Water absorption

CSB-EPB21塑料轴承在标准大气中的吸湿率为0.1%。浸泡在水中的最高吸水率为0.3%。极低吸水率不会导致轴承发生性能和尺寸变化，非常适合用于潮湿环境。

The moisture absorption of CSB-EPB21 plastic plain bearings is 0.1% in standard atmosphere. The max. water absorption is 0.3% in water. These values are very low, CSB-EPB21 plastic plain bearings is very well suited for used in wet applications.

抗UV性能 UV resistance

CSB-EPB21塑料轴承长久暴露在紫外线下材料表面会发生蜕变，抗压强度会下降。

Disintegration could be possible for the material CSB-EPB21 after long period of exposing under the UV ray and therefore the compressive strength will be reduced.

安装公差 Installation tolerances

CSB-EPB21塑料轴承压装后公差 Tolerances after pressfit

直径 Di. [mm]	CSB-EPB21 E10 [mm]	座孔 Housing H7 [mm]	轴 Shaft h9 [mm]
>0 ~ 3	+0.014 ~ +0.054	0 ~ +0.010	0 ~ -0.025
>3 ~ 6	+0.020 ~ +0.068	0 ~ +0.012	0 ~ -0.030
>6 ~ 10	+0.025 ~ +0.083	0 ~ +0.015	0 ~ -0.036
>10 ~ 18	+0.032 ~ +0.102	0 ~ +0.018	0 ~ -0.043
>18 ~ 30	+0.040 ~ +0.124	0 ~ +0.021	0 ~ -0.052
>30 ~ 50	+0.050 ~ +0.150	0 ~ +0.025	0 ~ -0.062
>50 ~ 80	+0.060 ~ +0.180	0 ~ +0.030	0 ~ -0.074
>80 ~ 120	+0.072 ~ +0.212	0 ~ +0.035	0 ~ -0.087
>120 ~ 180	+0.085 ~ +0.245	0 ~ +0.040	0 ~ -0.100

在不同轴材料上旋转时的磨损量 $p=2\text{MPa}$, $v=0.2\text{m/s}$

Wear under rotating with different shaft materials, $p = 2 \text{ MPa}$, $v = 0.2 \text{ m/s}$

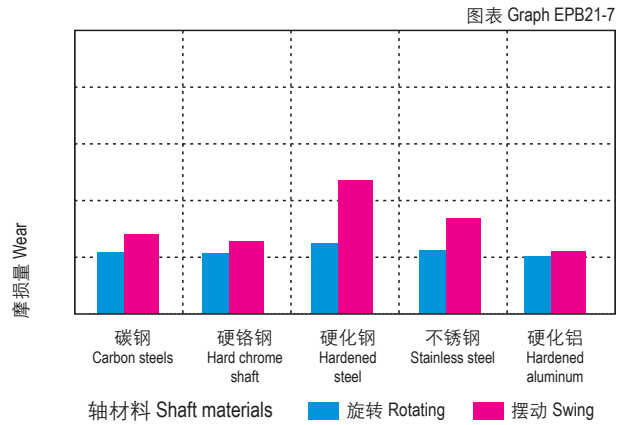

旋转磨损随轴材料与压力变化关系 $v=0.2\text{m/s}$

Wear & pressure under rotating with different shaft materials, $v = 0.2 \text{ m/s}$

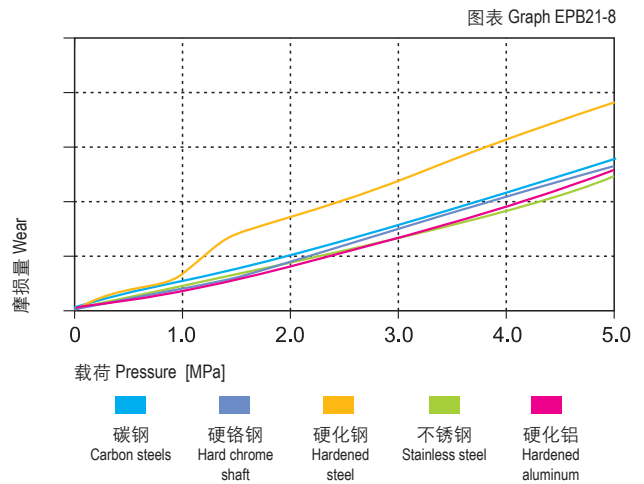

吸水性的影响

Effect of moisture absorption on EPB21 bearings

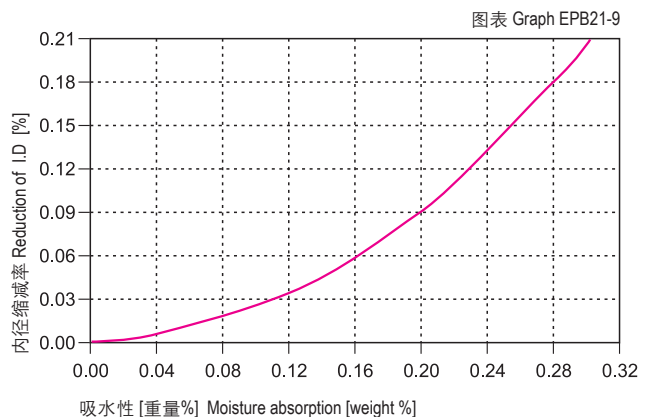

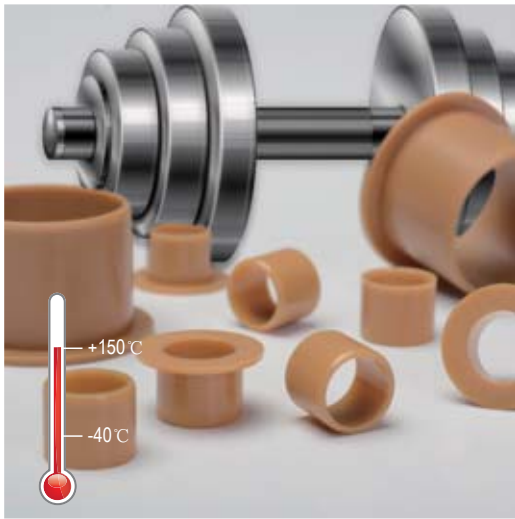

产品特性 Product features

- 极高载荷下耐磨性较好的材料。适用于其它CSB塑料轴承在极高载荷下摆动运动无法满足的场合
- 连续使用温度: -40℃/+150℃
- 承受较高载荷
- 适用于摆动场合
- 抗污垢能力强
- Good wear resistance under extremely high load condition. It is suitable for the applications that the other CSB plastic bearing materials are not working properly with the extremely high load and oscillation motion conditions
- Continuous working temperature: -40℃/+150℃
- Suitable for high load operation
- Good for oscillating operation
- Containment prevention ability

● 标准产品规格表 Standard specifications: P128

材料数据表 Material properties data table

材料性能 Material properties	测试标准 Standard	单位 Unit	CSB-EPB22
颜色 Color	-	-	浅棕色 Light brown
密度 Density	ISO1183	g/cm ³	1.49
最大吸湿率 Max. moisture absorption, 50%RH	ISO62	%	1.1
最大吸水率 Max. water absorption	ISO62	%	4.6
对钢动摩擦系数 Coefficient of sliding friction(steel)	ITS025	μ	0.15-0.35
极限PV值 Max. PV value	ITS026	N/mm ² × m/s	0.70
弯曲模量 Flexural modulus	ISO178	MPa	9000
弯曲强度 Flexural strength	ISO178	MPa	240
最大静载荷 Max. static load	ITS027	MPa	95
最大动载荷 Max. dynamic load	ITS028	MPa	49
邵氏硬度 Shore hardness	ISO868	D	80
连续运行温度 Long-term application temperature	ITS029	℃	+150
短时运行温度 Short-term application temperature	ITS029	℃	+220
最低运行温度 Lowest application temperature	ITS029	℃	-40
导热性 Thermal conductivity	ISO22007	W/m/K	0.24
线性热膨胀系数 Coefficient of thermal expansion	ISO11359	K ⁻¹ × 10 ⁻⁵	8
阻燃等级 Flammability	UL94	Class	HB
体电阻率 Volume resistance	IEC60093	Ω · cm	>10 ¹³
面电阻率 Surface resistance	IEC60093	Ω	>10 ¹¹

*ITS: CSB内部测试标准 CSB company's internal test standards.

**除非特殊说明测试温度为23℃ Test temperatures are 23℃ unless otherwise stated.

轴承PV值 PV value

CSB-EPB22塑料轴承最大运行PV值为0.7N/mm² × m/s; 由此决定轴承所承受的载荷与速度成反比, 详细查阅图表EPB22-1。

The max PV value of the CSB-EPB12 plastic bearings is 0.7N/mm² × m/s which determines the load capacity of bearing is inversely proportional to the speed. Please refer to the chart for more detailed information (Graph EPB12-1).

■ PV图表 Permissible PV value for CSB-EPB22

图表 Graph EPB22-1

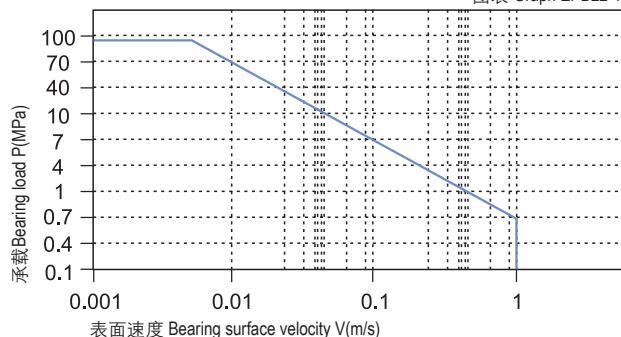

轴承的载荷、速度、温度 Load, speed and temperature

CSB-EPB22塑料轴承可承受最大静载荷为95Mpa，在此载荷下轴承的最大压缩变形量参考图表EPB22-2，轴承实际工作载荷略小于95Mpa，载荷还受到运行速度以及温度的影响，速度越快 (Vmax: 1.0m/s) 会导致摩擦温度上升，而温度上升 (Tmax: 150℃) 会导致轴承的承载能力逐渐减弱，载荷随轴承工作温度变化情况参考图表EPB22-3。

CSB-EPB22 allows the Max static load of 95Mpa, The max compressive deformation rate under the max load is listed in Graph EPB22-2, The actual load capacity of bearing is slightly less than 95Mpa. The bearing load is variable against the speed and temperature. Fast speed (Vmax: 1.0m/s) results into higher temperature (Tmax: 150℃) which decreases the load capacity of the bearing. Please refer to the Graph EPB22-3 for such variation.

轴承的摩擦系数、磨损、轴材料 Friction factor, wear and shaft material

摩擦系数 Friction factor

图表EPB22-4表明CSB-EPB22塑料轴承的摩擦系数在载荷保持不变的情况下受速度变化影响比较小；同样在图表EPB22-5表明CSB-EPB22塑料轴承在速度保持不变的情况下受载荷变化的影响相对也比较小；此轴承为所有滑动轴承中摩擦系数不受运行速度以及载荷影响较大的典型轴承。根据图表EPB22-6显示CSB-EPB22塑料轴承的摩擦系数在超过Ra0.4后轴表面粗糙度几乎对轴承的摩擦系数没有任何影响，我们推荐使用轴表面粗糙度为Ra0.1~0.4um。

Graph EPB22-4 shows that the friction factor of CSB-EPB22 is not considerably affected by the operation speed when the loading is stable. At the meantime, Graph EPB22-5 shows that the friction factor of CSB-EPB22 is not considerably affected by the loading when the operation speed is stable. This bearing is the only typical material whose friction factor is not sensitive to the operation speed and loading. Graph EPB22-6 tells that the friction factor of CSB-EPB22 will not be affected by the shaft roughness when the shaft roughness is better than Ra0.4. The recommended Shaft roughness is Ra0.1~0.4.

摩擦系数与轴表面粗糙度关系图表

Coefficient of friction & the surface roughness of shaft

图表 Graph EPB22-6

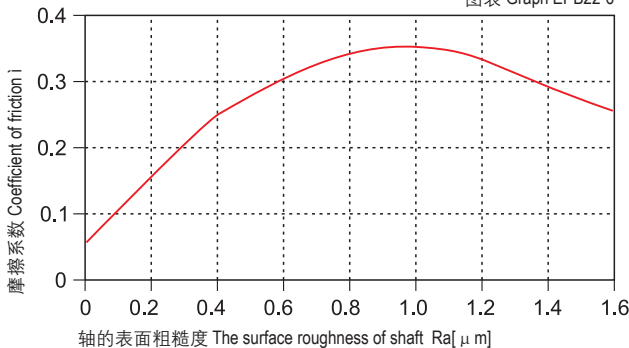

载荷-温度-变形量图表 Load-Temperature deformation

图表 Graph EPB22-2

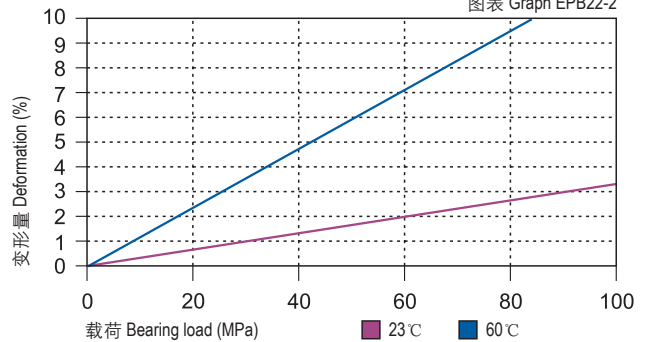

载荷-温度图表 Load-Temperature diagrams

图表 Graph EPB22-3

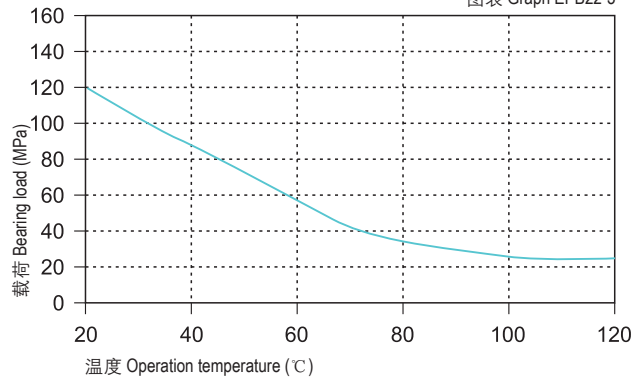

摩擦系数与速度变化关系图表 P=2MPa

Coefficient of friction & the speed of bearing, p = 2 MPa

图表 Graph EPB22-4

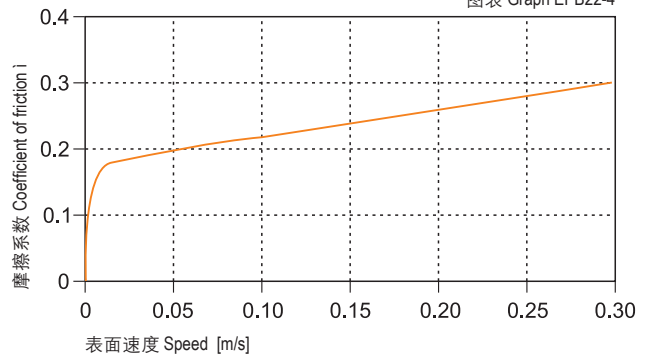

摩擦系数与载荷变化关系图表 v=0.2m/s

Coefficient of friction & the pressure of bearing, v = 0.2 m/s

图表 Graph EPB22-5

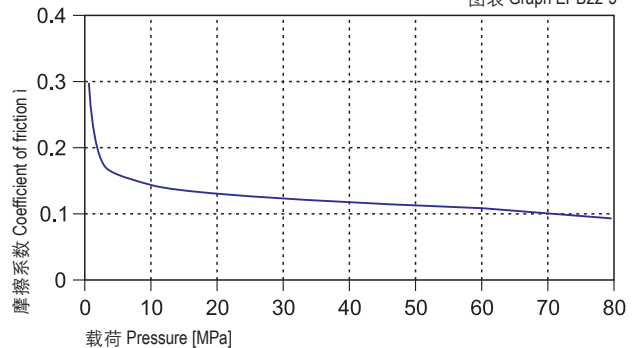

CSB-EPB22	干运行 Dry	油脂 Grease	油 Oil	水 Water
摩擦系数 μ Friction coef.	0.15-0.35	0.09	0.04	0.04

磨损与轴材料 Wearing and shaft material

图表EPB22-7与图表EPB22-8表明CSB-EPB22塑料轴承比较适合采用硬铬钢轴或硬化钢轴；图表EPB22-7表明CSB-EPB22塑料轴承在做摆动运动下的磨损性能要优越于在旋转运动下的磨损性能。CSB-EPB22塑料轴承在摆动运动时选择硬铬钢轴和硬化钢轴比较适合，在旋转运动中也是选择硬铬钢轴和硬化钢轴比较理想。

Graph EPB22-7 and Graph EPB22-8 tells that CSB-EPB22 is suitable for both hard chrome steel shaft and hardened steel shaft. The wearing feature of CSB-EPB22 is better in oscillation operation than in rotation operation. Hardened steel shaft and hardened aluminum shaft is the better choice under oscillation operation and hardened steel shaft and hardened chrome steel shaft is the better choice under rotation operation.

化学抗性 Chemical resistance

CSB-EPB22塑料轴承能抵抗弱碱以及各类润滑油的腐蚀。CSB-EPB22 is good at chemical resistance against weak acidic medium and various kinds of lubricants.

吸水性 Water absorption

CSB-EPB22塑料轴承在标准大气中的吸湿率为1.1%。浸泡在水中最高吸水率为4.6%。由于高吸水率的特性，我们必须考虑此轴承的应用环境。

The moisture absorption of CSB-EPB22 plastic plain bearings is 1.1% in standard atmosphere. The max. water absorption is 4.6% in water. The application environment has to be considered due to the high water absorption properties.

抗UV性能 UV resistance

CSB-EPB22塑料轴承长久暴露在紫外线下长久后材料可能会变脆，不能承受冲击力。

CSB-EPB22 can become brittle and lost its impact resistance when it is exposed into UV ray for a certain period of time.

安装公差 Installation tolerances

CSB-EPB22塑料轴承压装后公差 Tolerances after pressfit

直径 Di [mm]	CSB-EPB22 E10 [mm]	座孔 Housing H7 [mm]	轴 Shaft h9 [mm]
>0 ~ 3	+0.014 ~ +0.054	0 ~ +0.010	0 ~ -0.025
>3 ~ 6	+0.020 ~ +0.068	0 ~ +0.012	0 ~ -0.030
>6 ~ 10	+0.025 ~ +0.083	0 ~ +0.015	0 ~ -0.036
>10 ~ 18	+0.032 ~ +0.102	0 ~ +0.018	0 ~ -0.043
>18 ~ 30	+0.040 ~ +0.124	0 ~ +0.021	0 ~ -0.052
>30 ~ 50	+0.050 ~ +0.150	0 ~ +0.025	0 ~ -0.062
>50 ~ 80	+0.060 ~ +0.180	0 ~ +0.030	0 ~ -0.074
>80 ~ 120	+0.072 ~ +0.212	0 ~ +0.035	0 ~ -0.087
>120 ~ 180	+0.085 ~ +0.245	0 ~ +0.040	0 ~ -0.100

在不同轴材料上旋转时的磨损量 $p=2\text{MPa}$, $v=0.2\text{m/s}$

Wear under rotating with different shaft materials, $p = 2 \text{ MPa}$, $v = 0.2 \text{ m/s}$

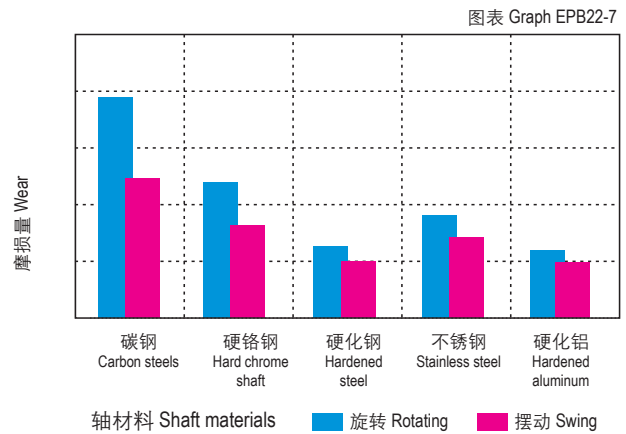

旋转磨损随轴材料与压力变化关系 $v=0.2\text{m/s}$

Wear & pressure under rotating with different shaft materials, $v = 0.2 \text{ m/s}$

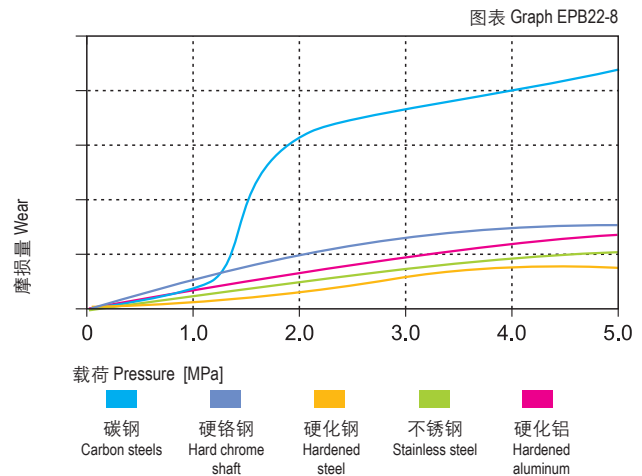

吸水性的影响

Effect of moisture absorption on EPB22 bearings

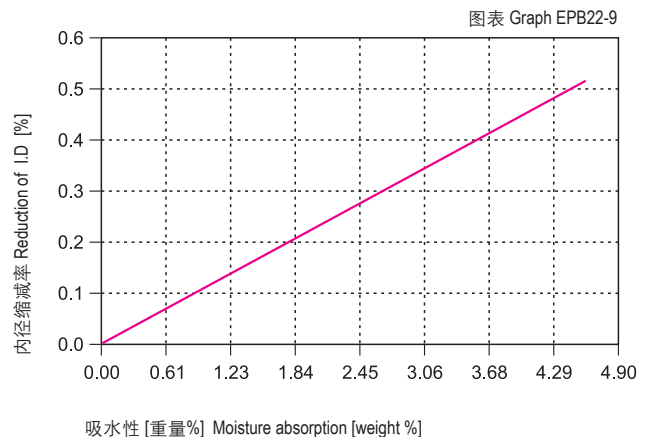

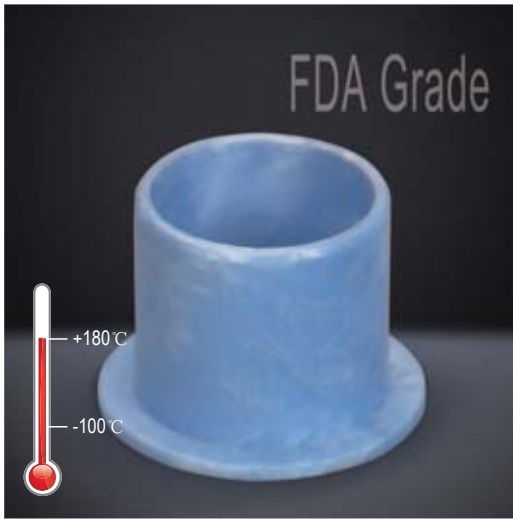

● 标准产品规格表 Standard specifications: P138

产品特性 Product features

- 符合FDA标准的高温耐磨材料。因用于食品机械或与食品接触的场所。可在180度下保持良好的耐磨性能
- 连续使用温度: -100℃/+180℃
- 高载荷下耐磨
- 高温下食品行业应用
- 符合FDA标准
- High temperature and wear resistance material conforms to FDA regulation. It is suitable for the food machinery where the food is directly contacted with the material under the high temperature of 180℃
- Continuous working temperature: -100℃/+180℃
- Good wear resistance under high load
- For food industry under high temperature
- No special requirement on the surface roughness
- FDA standard

材料数据表 Material properties data table

材料性能 Material properties	测试标准 Standard	单位 Unit	CSB-EPB23
颜色 Color	-	-	蓝色 Blue
密度 Density	ISO1183	g/cm ³	1.42
最大吸湿率 Max. moisture absorption, 50%RH	ISO62	%	0.6
最大吸水率 Max. water absorption	ISO62	%	1.9
对钢动摩擦系数 Coefficient of sliding friction(steel)	ITS025	μ	0.10-0.20
极限PV值 Max. PV value	ITS026	N/mm ² × m/s	0.40
弯曲模量 Flexural modulus	ISO178	MPa	2000
弯曲强度 Flexural strength	ISO178	MPa	110
最大静载荷 Max. static load	ITS027	MPa	60
最大动载荷 Max. dynamic load	ITS028	MPa	26
邵氏硬度 Shore hardness	ISO868	D	76
连续运行温度 Long-term application temperature	ITS029	℃	+180
短时运行温度 Short-term application temperature	ITS029	℃	+210
最低运行温度 Lowest application temperature	ITS029	℃	-100
导热性 Thermal conductivity	ISO22007	W/m/K	0.24
线性热膨胀系数 Coefficient of thermal expansion	ISO11359	K ⁻¹ × 10 ⁻⁵	8
阻燃等级 Flammability	UL94	Class	V0
体电阻率 Volume resistance	IEC60093	Ω · cm	>10 ¹¹
面电阻率 Surface resistance	IEC60093	Ω	>10 ¹¹

*ITS: CSB内部测试标准 CSB company's internal test standards.

**除非特殊说明测试温度为23℃ Test temperatures are 23℃ unless otherwise stated.

轴承PV值 PV value

CSB-EPB23塑料轴承最大运行PV值为0.4N/mm² × m/s; 由此决定轴承所承受的载荷与速度成反比, 详细查阅图表EPB23-1。

The max PV value of the CSB-EPB23 plastic bearings is 0.4N/mm² × m/s which determines the load capacity of bearing is inversely proportional to the speed. Please refer to the chart for more detailed information (Graph EPB23-1).

■ PV图表 Permissible PV value for CSB-EPB23

图表 Graph EPB23-1

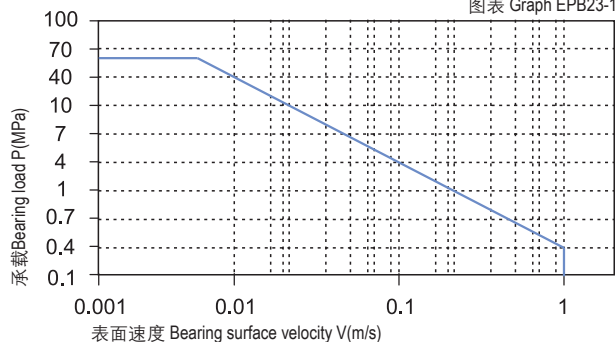

轴承的载荷、速度、温度 Load, speed and temperature

CSB-EPB23塑料轴承可承受最大静载荷为60Mpa，在此载荷下轴承的最大压缩变形量参考图表EPB23-2，轴承实际工作载荷略小于60Mpa，载荷还受到运行速度以及温度的影响，速度越快 (Vmax: 1.0m/s) 会导致摩擦温度上升，而温度上升 (Tmax: 180℃) 会导致轴承的承载能力逐渐减弱，载荷随轴承工作温度变化情况参考图表EPB23-3。

CSB-EPB23 allows the Max static load of 60Mpa, The max compressive deformation rate under the max load is listed in Graph EPB23-2, The actual load capacity of bearing is slightly less than 60Mpa, The bearing load is variable against the speed and temperature, Fast speed (Vmax: 1.0m/s) results into higher temperature (Tmax: 180℃) which decreases the load capacity of the bearing. Please refer to the Graph EPB23-3 for such variation.

轴承的摩擦系数、磨损、轴材料 Friction factor, wear and shaft material

摩擦系数 Friction factor

图表EPB23-4表明CSB-EPB23塑料轴承的摩擦系数随着运动速度的变化影响较小，而图表EPB23-5表明CSB-EPB23塑料轴承的摩擦系数随着载荷的增加明显减小，在载荷超过20Mpa是逐渐趋于平稳；图表EPB23-6表明CSB-EPB23塑料轴承的摩擦系数受轴粗糙度的影响也相对比较小；虽然如此，我们还是建议轴的表面不能太光滑，也不能过于出差，推荐使用轴的粗糙度为Ra0.6 ~ 0.9um;

CSB-EPB23 Bearing Friction factor is not so sensitive to the operation speed (see Graph EPB23-4). The friction factor is considerably decreased along with the loading increasing and it will be turned to be stable when the loading reaches 20Mpa. Graph EPB23-5 shows the friction factor of the bearing is also not sensitive to the shaft roughness but we still recommend that the roughness of the shaft should be neither too smooth nor too rough. It is recommended to keep the roughness of the shaft to be within the range of Ra0.6 to Ra0.9.

摩擦系数与轴表面粗糙度关系图表

Coefficient of friction & the surface roughness of shaft

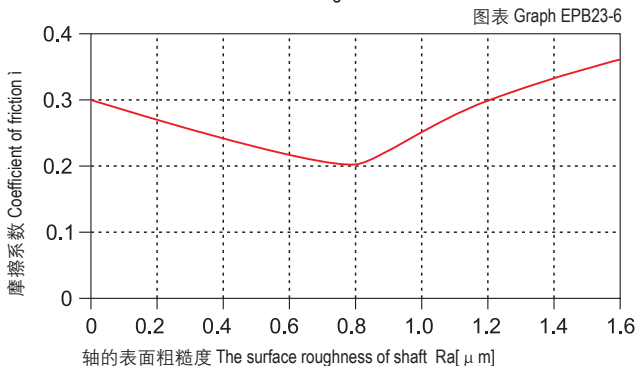

载荷-温度-变形量图表 Load-Temperature deformation

图表 Graph EPB23-2

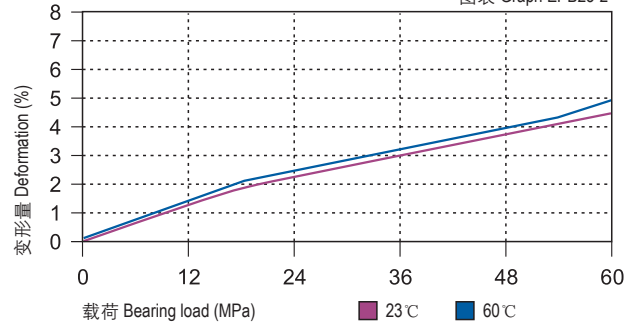

载荷-温度图表 Load-Temperature diagrams

图表 Graph EPB23-3

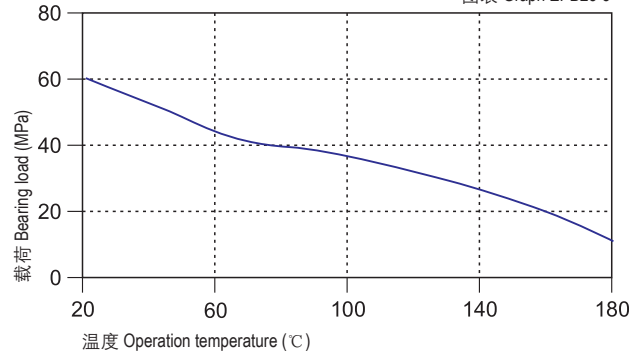

摩擦系数与速度变化关系图表 P=2MPa

Coefficient of friction & the speed of bearing, p = 2 MPa

图表 Graph EPB23-4

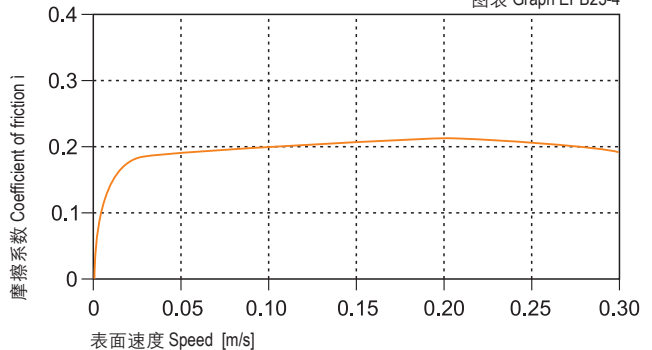

摩擦系数与载荷变化关系图表 v=0.2m/s

Coefficient of friction & the pressure of bearing, v = 0.2 m/s

图表 Graph EPB23-5

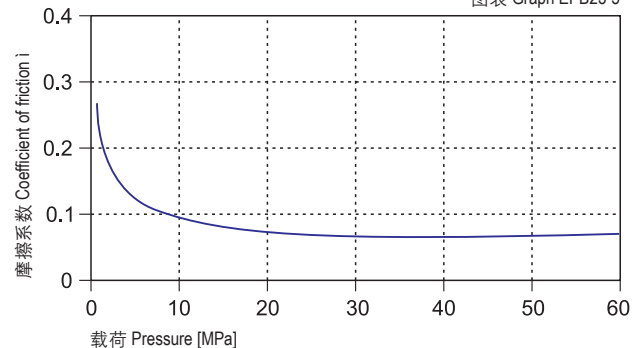

CSB-EPB23	干运行 Dry	油脂 Grease	油 Oil	水 Water
摩擦系数 μ Friction coef.	0.10~0.20	0.09	0.04	0.04

磨损与轴材料 Wearing and shaft material

图表EPB23-7表明CSB-EPB23塑料轴承在2Mpa下做旋转运动时，磨损随着轴材料的变化较大；通过实验表明CSB-EPB23塑料轴承在做旋转运动时比较适合用于硬铬轴，不锈钢轴和硬铬轴上用于CSB-EPB23塑料轴承能获得良好的运行效果。图表EPB23-8表明硬铬轴更适合用于高载荷下的CSB-EPB23塑料轴承，随着载荷的不断增加，轴承的磨损速率却变化较小，图表EPB23-8表明CSB-EPB23塑料轴承在不同载荷下的差异。

Graph EPB23-7 shows that the CSB-EPB23 material is not sensitive with different materials under the rotating operation. It is suitable for hard shaft and high speed steel shaft as well as hard chrome steel shaft. Graph EPB23-8 shows that the hard chrome steel shaft is most suitable for using CSB-EPB23 bearing because the wearing speed is not sensitive when the loading is increased. From the Graph EPB23-8, it shows that CSB-EP23 features different performance.

化学抗性 Chemical resistance

CSB-EPB23塑料轴承能抵抗弱碱以及各类润滑油的腐蚀。CSB-EPB23 is good at chemical resistance against weak acidic medium and various kinds of lubricants.

吸水性 Water absorption

CSB-EPB23塑料轴承在标准大气中的吸湿率为0.6%。浸泡在水中最高吸水率为1.9%。较低的吸水率只有在极端应用中才需要更改轴承设计。

The moisture absorption of CSB-EPB23 plastic bearings is 0.6% in standard atmosphere. The max. water absorption is 1.9% in water. These values are so low that design changes due to absorption are only necessary in extreme applications.

抗UV性能 UV resistance

CSB-EPB23塑料轴承长久暴露在紫外线下颜色会发生褪变。材料性能基本都不会发生改变。

The color of CSB-EPB23 could be dimmed when it is exposed into the UV ray. The material performance stays stable.

安装公差 Installation tolerances

CSB-EPB23塑料轴承压装后公差 Tolerances after pressfit

直径 Di. [mm]	CSB-EPB23 E10 [mm]	座孔 Housing H7 [mm]	轴 Shaft h9 [mm]
>0 ~ 3	+0.014 ~ +0.054	0 ~ +0.010	0 ~ -0.025
>3 ~ 6	+0.020 ~ +0.068	0 ~ +0.012	0 ~ -0.030
>6 ~ 10	+0.025 ~ +0.083	0 ~ +0.015	0 ~ -0.036
>10 ~ 18	+0.032 ~ +0.102	0 ~ +0.018	0 ~ -0.043
>18 ~ 30	+0.040 ~ +0.124	0 ~ +0.021	0 ~ -0.052
>30 ~ 50	+0.050 ~ +0.150	0 ~ +0.025	0 ~ -0.062

在不同轴材料上旋转时的磨损量 $p=2\text{MPa}$, $v=0.2\text{m/s}$

Wear under rotating with different shaft materials, $p = 2 \text{ MPa}$, $v = 0.2 \text{ m/s}$

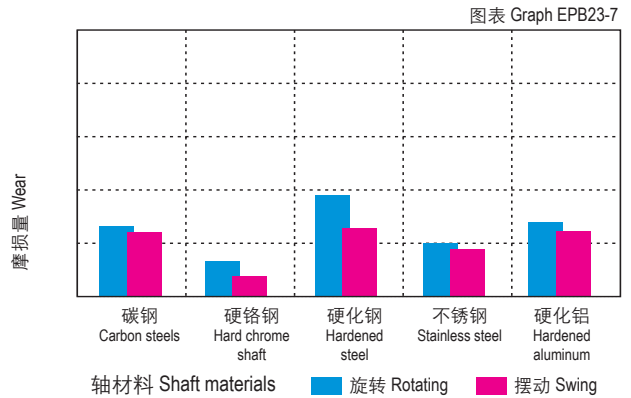

旋转磨损随轴材料与压力变化关系 $v=0.2\text{m/s}$

Wear & pressure under rotating with different shaft materials, $v = 0.2 \text{ m/s}$

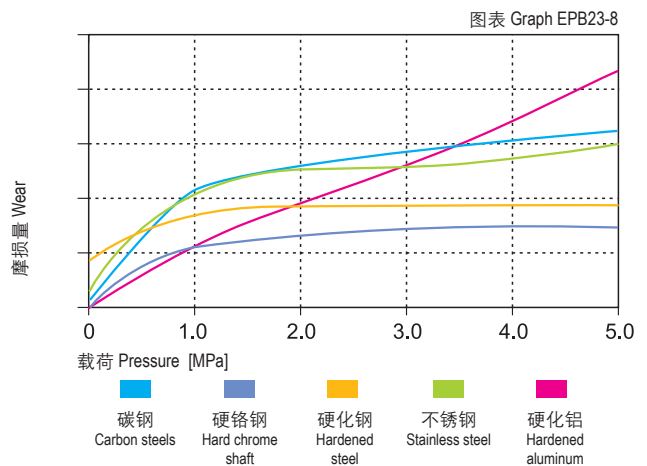

吸水性的影响

Effect of moisture absorption on EPB23 bearings

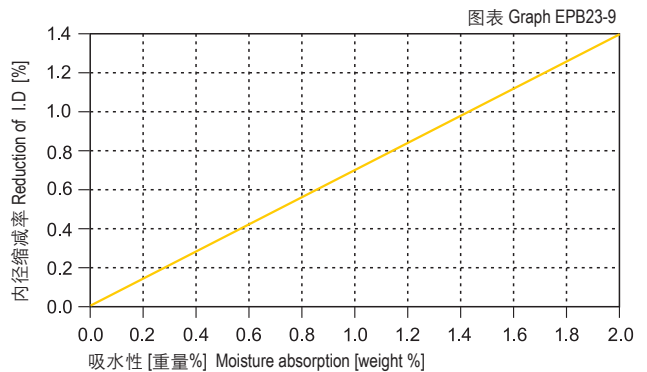

直径 Di. [mm]	CSB-EPB23 E10 [mm]	座孔 Housing H7 [mm]	轴 Shaft h9 [mm]
>50 ~ 80	+0.060 ~ +0.180	0 ~ +0.030	0 ~ -0.074
>80 ~ 120	+0.072 ~ +0.212	0 ~ +0.035	0 ~ -0.087
>120 ~ 180	+0.085 ~ +0.245	0 ~ +0.040	0 ~ -0.100



产品特性 Product features

- 汽车行业标准材料。高温应用良好的性价比。在燃油中能保持极好的耐磨性能
- 连续使用温度: -40°C/+200°C
- 高温低成本解决方案
- 应用燃油中
- 良好的化学抗性
- 适合潮湿环境中使用
- Standard material for automotive industrial. Best and economic material for high temperature application. Excellent wear resistance is available in the vehicle fuels.
- Continuous working temperature: -40°C/+200°C
- High temperature and lower cost
- High wear resistance under fuel oil
- Good chemical resistance
- Suitable for humid environment

● 标准产品规格表 Standard specifications: P132

材料数据表 Material properties data table

材料性能 Material properties	测试标准 Standard	单位 Unit	CSB-EPB24
颜色 Color	-	-	棕色 Brown
密度 Density	ISO1183	g/cm ³	1.72
最大吸湿率 Max. moisture absorption, 50%RH	ISO62	%	0.1
最大吸水率 Max. water absorption	ISO62	%	0.2
对钢动摩擦系数 Coefficient of sliding friction(steel)	ITS025	μ	0.08-0.25
极限PV值 Max. PV value	ITS026	N/mm ² × m/s	0.60
弯曲模量 Flexural modulus	ISO178	MPa	10000
弯曲强度 Flexural strength	ISO178	MPa	210
最大静载荷 Max. static load	ITS027	MPa	110
最大动载荷 Max. dynamic load	ITS028	MPa	58
邵氏硬度 Shore hardness	ISO868	D	81
连续运行温度 Long-term application temperature	ITS029	°C	+200
短时运行温度 Short-term application temperature	ITS029	°C	+240
最低运行温度 Lowest application temperature	ITS029	°C	-40
导热性 Thermal conductivity	ISO22007	W/m/K	0.24
线性热膨胀系数 Coefficient of thermal expansion	ISO11359	K ⁻¹ × 10 ⁻⁵	5
阻燃等级 Flammability	UL94	Class	V0
体电阻率 Volume resistance	IEC60093	Ω · cm	>10 ¹³
面电阻率 Surface resistance	IEC60093	Ω	>10 ¹²

*ITS: CSB内部测试标准 CSB company's internal test standards.

**除非特殊说明测试温度为23°C Test temperatures are 23°C unless otherwise stated.

轴承PV值 PV value

CSB-EPB24塑料轴承最大运行PV值0.6N/mm² × m/s; 由此决定轴承所承受的载荷与速度成反比, 详细查阅图表EPB24-1。

The max PV value of the CSB-EPB24 plastic bearings is 0.6N/mm² × m/s which determines the load capacity of bearing is inversely proportional to the speed. Please refer to the chart for more detailed information (Graph EPB24-1).

■ PV图表 Permissible PV value for CSB-EPB24

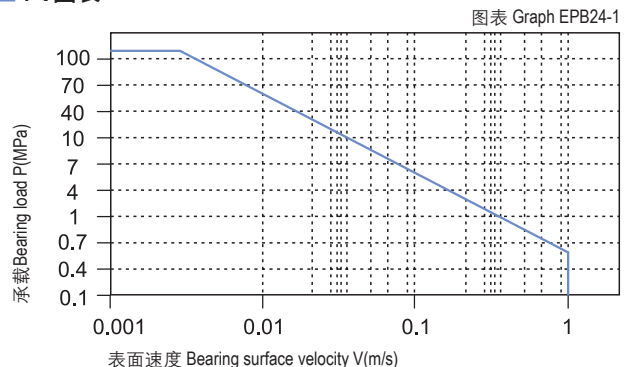

轴承的载荷、速度、温度 Load, speed and temperature

CSB-EPB24塑料轴承可承受最大静载荷为110Mpa，在此载荷下轴承的最大压缩变形量参考图表EPB24-2，轴承实际工作载荷略小于110Mpa，载荷还受到运行速度以及温度的影响，速度越快 (Vmax: 1.0m/s) 会导致摩擦温度上升，而温度上升 (Tmax: 200℃) 会导致轴承的承载能力逐渐减弱，载荷随轴承工作温度变化情况参考图表EPB24-3。

CSB-EPB24 allows the Max static load of 110Mpa, The max compressive deformation rate under the max load is listed in Graph EPB24-1, The actual load capacity of bearing is slightly less than 110Mpa, The bearing load is variable against the speed and temperature, Fast speed (Vmax: 1.0m/s) results into higher temperature (Tmax: 200℃) which decreases the load capacity of the bearing. Please refer to the Graph EPB24-3 for such variation.

轴承的摩擦系数、磨损、轴材料 Friction factor, wear and shaft material

摩擦系数 Friction factor

图表EPB24-4表明CSB-EPB24塑料轴承的摩擦系数在载荷保持不变的情况下受运行速度的增加影响相对较小；图表EPB24-5表明CSB-EPB24塑料轴承在保持速度不变的情况下，载荷从0增加到20Mpa过程中摩擦系数会逐步降低，而当载荷高于20Mpa时摩擦系数随着载荷的增加影响较小。图表EPB24-6表明CSB-EPB24塑料轴承的摩擦系数会随着轴表面粗糙度的增大而逐渐升高，我们推荐合适的轴粗糙度为Ra0.1 ~ 0.6μm。

Graph EPB24-4 shows the friction factor of CSB-EPB24 is not obviously effected by the operation speed when the loading is stable and Graph EPB24-5 shows it will be decreasing along with the loading is increased from 0 to 20 Mpa when the operation speed is unchanged, furthermore the friction factor will not be changed when the loading reaches 20Mpa upward. The friction factor of CSB-EPB24 is increased along with the increasing of the shaft roughness. The recommended shaft roughness is Ra0.1 to Ra0.6.

摩擦系数与轴表面粗糙度关系图表 Coefficient of friction & the surface roughness of shaft

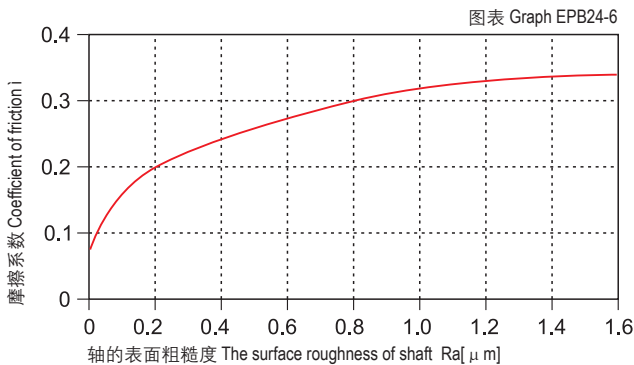

载荷-温度-变形量图表 Load-Temperature deformation

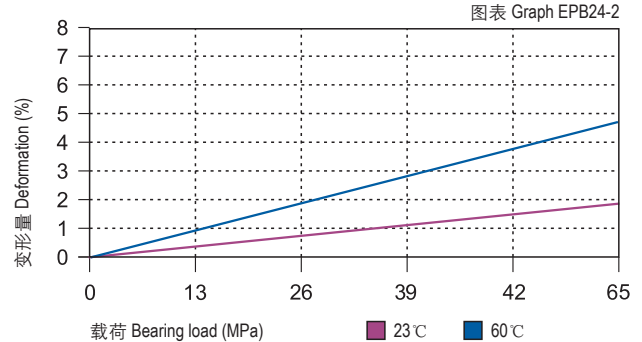

载荷-温度图表 Load-Temperature diagrams

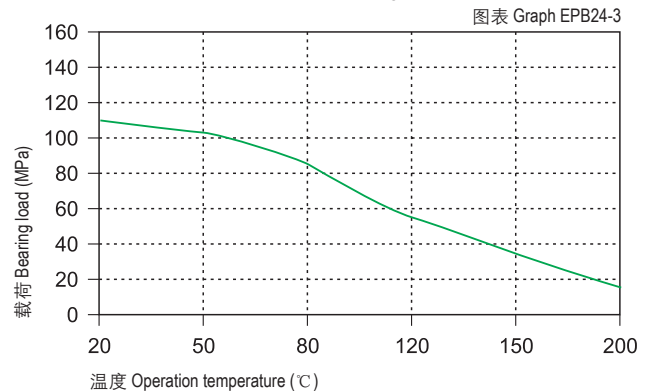

摩擦系数与速度变化关系图表 P=2MPa Coefficient of friction & the speed of bearing, p = 2 MPa

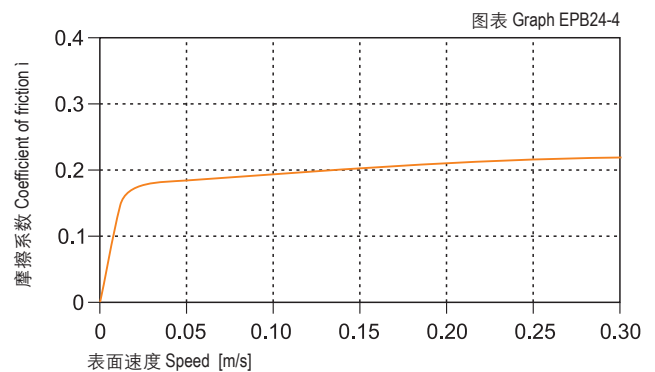

摩擦系数与载荷变化关系图表 v=0.2m/s Coefficient of friction & the pressure of bearing, v = 0.2 m/s

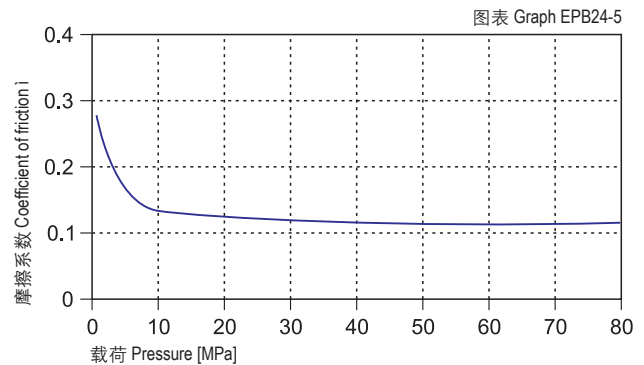

CSB-EPB24	干运行 Dry	油脂 Grease	油 Oil	水 Water
摩擦系数 μ Friction coef.	0.08~0.25	0.09	0.04	0.04

磨损与轴材料 Wearing and shaft material

图表EPB24-7与图表EPB24-8表明CSB-EPB24塑料轴承适用于硬质轴，在硬化钢轴和碳钢轴上运行同样出色；但是硬铬钢轴不适合用于CSB-EPB24塑料轴承。CSB-EPB24塑料轴承在做摆动运动下的磨损要略好于旋转运动下的磨损，且当载荷超过10Mpa时轴承的磨损会很快增加。

Graph EPB24-7 and Graph EPB24-8 tells that the CSB-EPB24 is very good for Hardened shaft and soft shaft and it features excellent both on hardened steel shaft and carbon steel shaft but the hardened chrome steel shaft is not good for CSB-EPB24 bearings. The wearing of CSB-EPB24 is better on oscillation operation than on rotation operation. The wearing will be increased when the loading is over 10Mpa.

化学抗性 Chemical resistance

CSB-EPB24塑料轴承具有很好的化学抗性，能抵抗绝大多数酸碱。
The Chemical Resistance of CSB-EPB24 is fairly good against most of Acid and Alkalis.

吸水性 Water absorption

CSB-EPB24塑料轴承在标准大气中的吸湿率为0.1%。浸泡在水中的最高吸水率为0.2%。极低吸水率不会导致轴承发生性能变化和尺寸变化，非常适合用于潮湿环境。

The moisture absorption of CSB-EPB24 plastic plain bearings is 0.1% in standard atmosphere. The max. water absorption is 0.2% in water. These values are very low, CSB-EPB24 plastic plain bearings is very well suited for used in wet applications.

抗UV性能 UV resistance

CSB-EPB24塑料轴承长久暴露在紫外线下材料表面会发生蜕变，抗压强度会下降。

Disintegration could be possible for the material CSB-EPB24 after long period of exposing under the UV ray and therefore the compressive strength will be reduced.

安装公差 Installation tolerances

CSB-EPB24塑料轴承压装后公差 Tolerances after pressfit

直径 Di. [mm]	CSB-EPB24 F10 [mm]	座孔 Housing H7 [mm]	轴 Shaft h9 [mm]
>0 ~ 3	+0.006 ~ +0.046	0 ~ +0.010	0 ~ -0.025
>3 ~ 6	+0.010 ~ +0.058	0 ~ +0.012	0 ~ -0.030
>6 ~ 10	+0.013 ~ +0.071	0 ~ +0.015	0 ~ -0.036
>10 ~ 18	+0.016 ~ +0.086	0 ~ +0.018	0 ~ -0.043
>18 ~ 30	+0.020 ~ +0.104	0 ~ +0.021	0 ~ -0.052
>30 ~ 50	+0.025 ~ +0.125	0 ~ +0.025	0 ~ -0.062

在不同轴材料上旋转时的磨损量 $p=2\text{MPa}$, $v=0.2\text{m/s}$ Wear under rotating with different shaft materials, $p = 2 \text{ MPa}$, $v = 0.2 \text{ m/s}$

图表 Graph EPB24-7

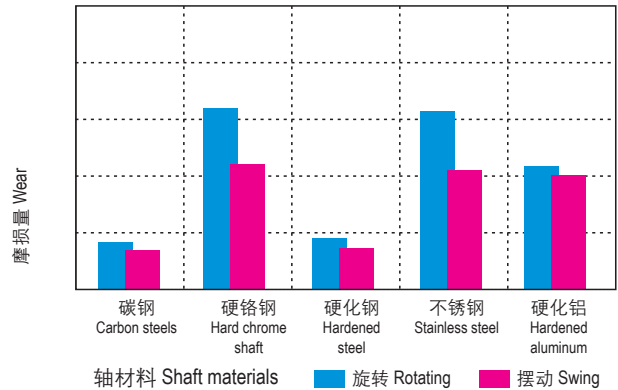

旋转磨损随轴材料与压力变化关系 $v=0.2\text{m/s}$ Wear & pressure under rotating with different shaft materials, $v = 0.2 \text{ m/s}$

图表 Graph EPB24-8

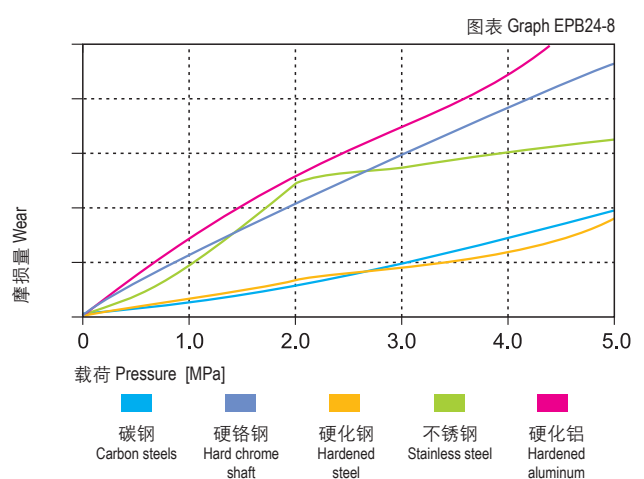

吸水性的影响 Effect of moisture absorption on EPB24 bearings

图表 Graph EPB24-9

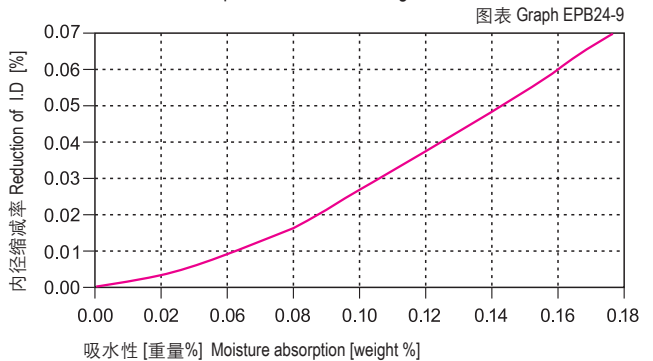

直径 Di. [mm]	CSB-EPB24 F10 [mm]	座孔 Housing H7 [mm]	轴 Shaft h9 [mm]
>50 ~ 80	+0.030 ~ +0.150	0 ~ +0.030	0 ~ -0.074
>80 ~ 120	+0.036 ~ +0.176	0 ~ +0.035	0 ~ -0.087
>120 ~ 180	+0.043 ~ +0.203	0 ~ +0.040	0 ~ -0.100

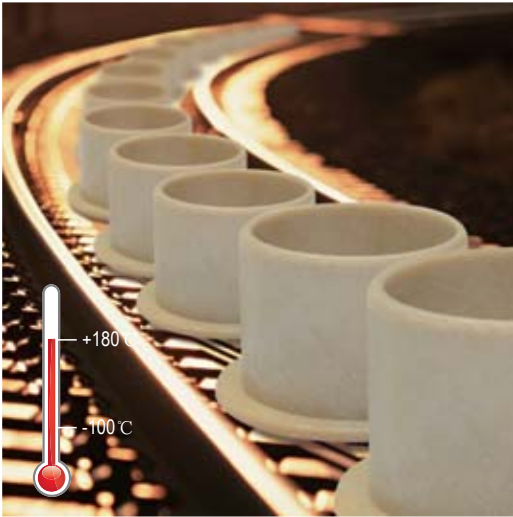

● 标准产品规格表 Standard specifications: P138

产品特性 Product features

- 高温180度下高耐磨材料。在旋转运动中耐磨性更为出色。对轴材料硬度要求较低
- 连续使用温度: -100℃/+180℃
- 适合于运行、免维护
- 应用于中高载荷
- 较低的摩擦系数
- Good wear resistance material under high temperature of 180℃. Better wear resistance for the rotation application and it has no critical requirement about the shaft hardness
- Continuous working temperature: -100℃/+180℃
- Maintenance-free dry operation
- Suitable in high load
- Lower friction

材料数据表 Material properties data table

材料性能 Material properties	测试标准 Standard	单位 Unit	CSB-EPB25
颜色 Color	-	-	黄色 Yellow
密度 Density	ISO1183	g/cm ³	1.44
最大吸湿率 Max. moisture absorption, 50%RH	ISO62	%	0.3
最大吸水率 Max. water absorption	ISO62	%	1.6
对钢动摩擦系数 Coefficient of sliding friction(steel)	ITS025	μ	0.08-0.20
极限PV值 Max. PV value	ITS026	N/mm ² × m/s	0.45
弯曲模量 Flexural modulus	ISO178	MPa	4500
弯曲强度 Flexural strength	ISO178	MPa	100
最大静载荷 Max. static load	ITS027	MPa	60
最大动载荷 Max. dynamic load	ITS028	MPa	30
邵氏硬度 Shore hardness	ISO868	D	79
连续运行温度 Long-term application temperature	ITS029	℃	+180
短时运行温度 Short-term application temperature	ITS029	℃	+220
最低运行温度 Lowest application temperature	ITS029	℃	-100
导热性 Thermal conductivity	ISO22007	W/m/K	0.24
线性热膨胀系数 Coefficient of thermal expansion	ISO11359	K ⁻¹ × 10 ⁻⁵	7
阻燃等级 Flammability	UL94	Class	V0
体电阻率 Volume resistance	IEC60093	Ω·cm	>10 ¹³
面电阻率 Surface resistance	IEC60093	Ω	>10 ¹⁰

*ITS: CSB内部测试标准 CSB company's internal test standards.

**除非特殊说明测试温度为23℃ Test temperatures are 23℃ unless otherwise stated.

轴承PV值 PV value

CSB-EPB25塑料轴承最大运行PV值为0.45N/mm² × m/s; 由此决定轴承所承受的载荷与速度成反比, 详细查阅图表EPB25-1。

The max PV value of the CSB-EPB25 plastic bearings is 0.45N/mm² × m/s which determines the load capacity of bearing is inversely proportional to the speed. Please refer to the chart for more detailed information (Graph EPB25-1).

■ PV图表 Permissible PV value for CSB-EPB25

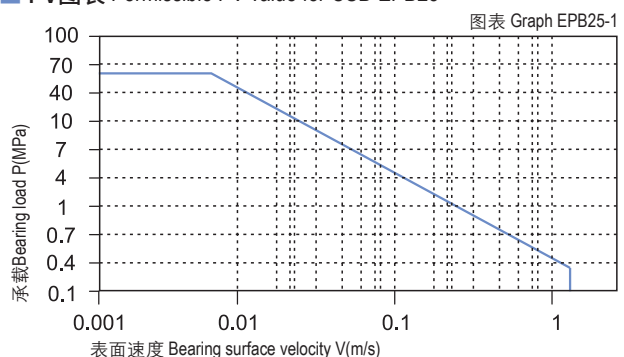

轴承的载荷、速度、温度 Load, speed and temperature

CSB-EPB25塑料轴承可承受最大静载荷为60Mpa，在此载荷下轴承的最大压缩变形量参考图表EPB25-2，轴承实际工作载荷略小于60Mpa，载荷还受到运行速度以及温度的影响，速度越快 (Vmax: 1.3m/s) 会导致摩擦温度上升，而温度上升 (Tmax: 180℃) 会导致轴承的承载能力逐渐减弱，载荷随轴承工作温度变化情况参考图表EPB25-3。

CSB-EPB25 allows the Max static load of 60Mpa, The max compressive deformation rate under the max load is listed in Graph EPB25-2, The actual load capacity of bearing is slightly less than 60Mpa, The bearing load is variable against the speed and temperature, Fast speed (Vmax: 1.3m/s) results into higher temperature (Tmax: 180℃) which decreases the load capacity of the bearing. Please refer to the Graph EPB25-3 for such variation.

轴承的摩擦系数、磨损、轴材料 Friction factor, wear and shaft material

摩擦系数 Friction factor

图表EPB25-4表明CSB-EPB25塑料轴承的摩擦系数随着运动速度的变化影响较小，而图表EPB25-5表明CSB-EPB25塑料轴承的摩擦系数随着载荷的增加明显减小，在载荷超过20Mpa是逐渐趋于平稳；图表EPB25-6表明CSB-EPB25塑料轴承的摩擦系数受轴粗糙度的影响也相对比较小；虽然如此，我们还是建议轴的表面不能太光滑，也不能过于出差，推荐使用轴的粗糙度为Ra0.7 ~ 0.9μm；

Graph EPB25-4 shows that the friction factor of CSB-EPB25 is not sensitive to the operation speed and Graph EPB25-5 shows that the friction factor is CSB-EPB25 is decreased along with the loading increasing and become stable when the loading is over 20Mpa. Graph EPB25-6 tells that the friction factor of CSB-EPB25 is also not sensitive to the shaft roughness but we still recommend the shaft roughness to be Ra0.7~0.9.

摩擦系数与轴表面粗糙度关系图表

Coefficient of friction & the surface roughness of shaft

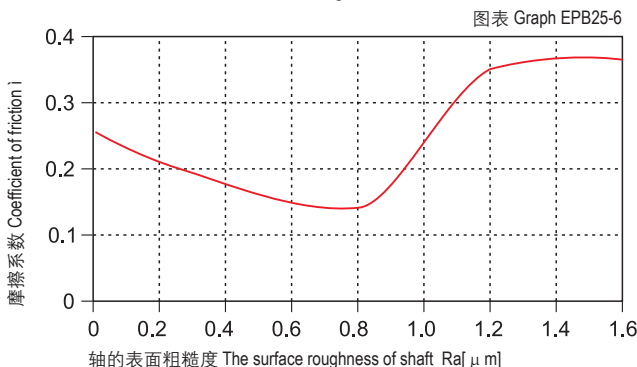

载荷-温度-变形量图表 Load-Temperature deformation

图表 Graph EPB25-2

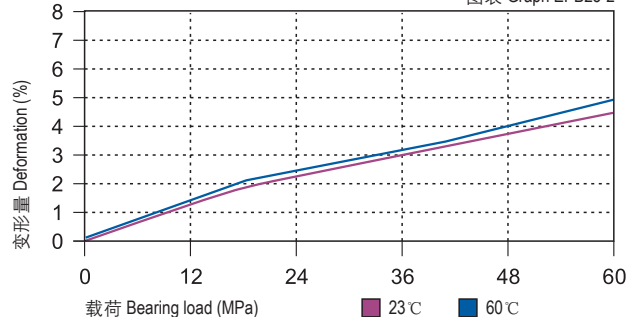

载荷-温度图表 Load-Temperature diagrams

图表 Graph EPB25-3

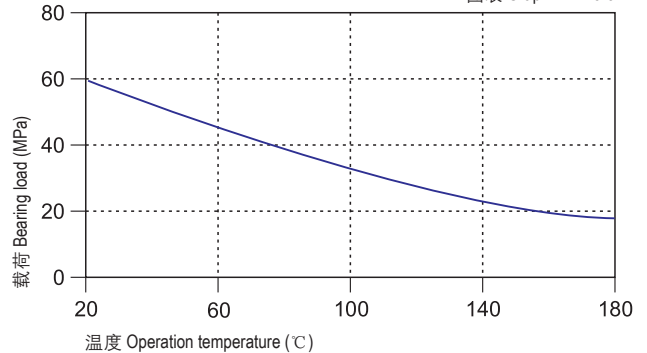

摩擦系数与速度变化关系图表 P=2MPa

Coefficient of friction & the speed of bearing, p = 2 MPa

图表 Graph EPB25-4

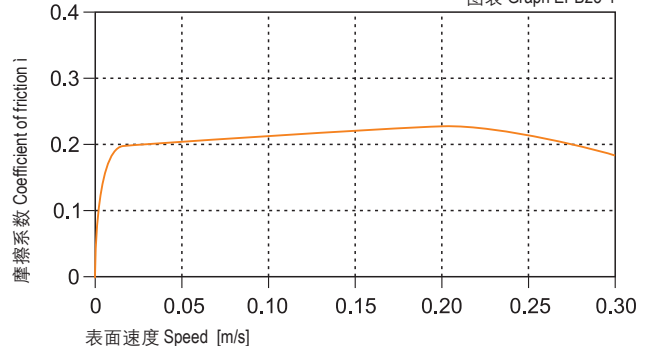

摩擦系数与载荷变化关系图表 v=0.2m/s

Coefficient of friction & the pressure of bearing, v = 0.2 m/s

图表 Graph EPB25-5

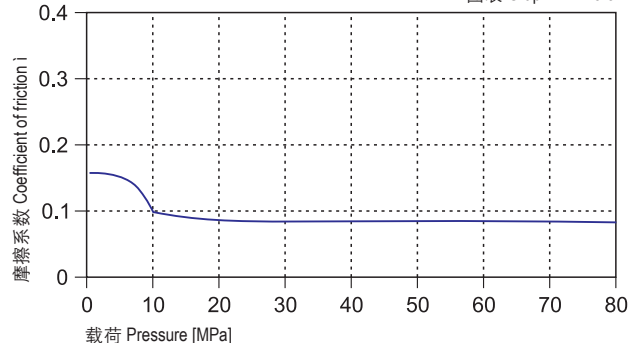

CSB-EPB25	干运行 Dry	油脂 Grease	油 Oil	水 Water
摩擦系数 μ Friction coef.	0.08~0.20	0.09	0.04	0.04

磨损与轴材料 Wearing and shaft material

图表EPB25-7与图表EPB25-8表明CSB-EPB25塑料轴承在2Mpa下做旋转运动时，磨损随着轴材料的变化较大；通过实验表明CSB-EPB25塑料轴承在做旋转运动时比较适合用于硬轴，硬化钢轴和不锈钢轴上用于CSB-EPB25塑料轴承能获得良好的运行效果。硬铬轴更适合用于高载荷下的CSB-EPB25塑料轴承，随着载荷的不断增大，轴承的磨损速率却变化较小。

Graph EPB25-7 and EPB25-8 shows that the wearing of CSB-EPB25 is sensitive to different materials under rotation operation with the loading of 2Mpa. It is suitable for hardened shaft, hardened steel shaft and stainless steel shaft in the rotation operation. Hardened chrome steel shaft is the best choice for CSB-EPB25. The wearing will be decreased as long as the loading increasing.

化学抗性 Chemical resistance

CSB-EPB25塑料轴承能抵抗弱碱以及各类润滑油的腐蚀。CSB-EPB25 is good at chemical resistance against weak acidic medium and various kinds of lubricants.

吸水性 Water absorption

CSB-EPB25塑料轴承在标准大气中的吸湿率为0.3%。浸泡在水中最高吸水率为1.6%。较低的吸水率只有在极端应用中才需要更改轴承设计。

The moisture absorption of CSB-EPB25 plastic bearings is 0.3% in standard atmosphere. The max. water absorption is 1.6% in water. These values are so low that design changes due to absorption are only necessary in extreme applications.

抗UV性能 UV resistance

CSB-EPB25塑料轴承长久暴露在紫外线下颜色基本不会改变。材料性能基本都不会发生改变。

CSB-EPB25 can maintain its color unchanged when it is exposed into the UV ray. The material performance stays stable.

安装公差 Installation tolerances

CSB-EPB25塑料轴承压装后公差 Tolerances after pressfit

直径 Di. [mm]	CSB-EPB25 E10 [mm]	座孔 Housing H7 [mm]	轴 Shaft h9 [mm]
>0 ~ 3	+0.014 ~ +0.054	0 ~ +0.010	0 ~ -0.025
>3 ~ 6	+0.020 ~ +0.068	0 ~ +0.012	0 ~ -0.030
>6 ~ 10	+0.025 ~ +0.083	0 ~ +0.015	0 ~ -0.036
>10 ~ 18	+0.032 ~ +0.102	0 ~ +0.018	0 ~ -0.043
>18 ~ 30	+0.040 ~ +0.124	0 ~ +0.021	0 ~ -0.052

在不同轴材料上旋转时的磨损量 $p=2\text{MPa}$, $v=0.2\text{m/s}$ Wear under rotating with different shaft materials, $p = 2 \text{ MPa}$, $v = 0.2 \text{ m/s}$

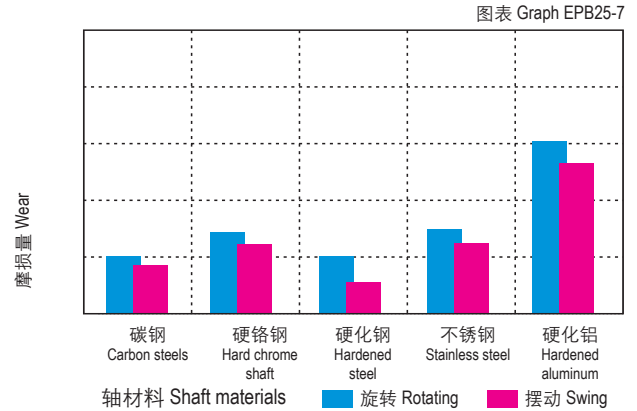

旋转磨损随轴材料与压力变化关系 $v=0.2\text{m/s}$ Wear & pressure under rotating with different shaft materials, $v = 0.2 \text{ m/s}$

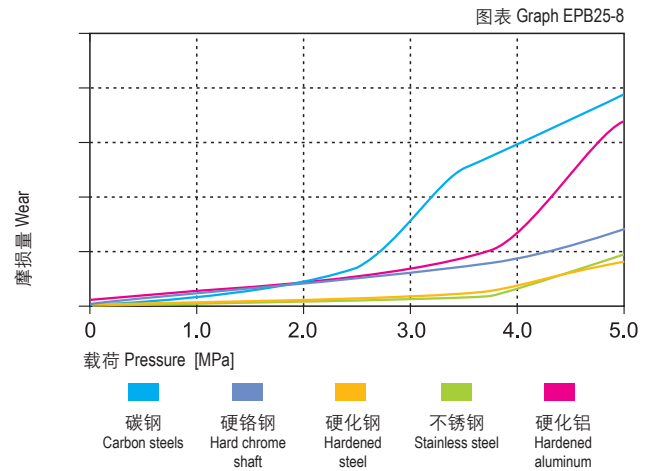

吸水性的影响 Effect of moisture absorption on EPB25 bearings

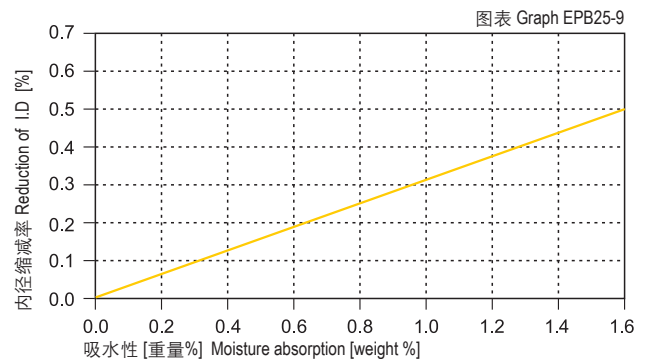

直径 Di. [mm]	CSB-EPB25 E10 [mm]	座孔 Housing H7 [mm]	轴 Shaft h9 [mm]
>30 ~ 50	+0.050 ~ +0.150	0 ~ +0.025	0 ~ -0.062
>50 ~ 80	+0.060 ~ +0.180	0 ~ +0.030	0 ~ -0.074
>80 ~ 120	+0.072 ~ +0.212	0 ~ +0.035	0 ~ -0.087
>120 ~ 180	+0.085 ~ +0.245	0 ~ +0.040	0 ~ -0.100



产品特性 Product features

- 适用于软轴
- 耐磨性高
- 最高使用温度+200℃
- 高化学抗性
- 高弹性
- For soft shafts
- Excellent wear resistance
- Operation temperatures up to +200 °C
- Good resistance to chemicals
- High elasticity

● 标准产品规格表 Standard specifications: P128

材料数据表 Material properties data table

材料性能 Material properties	测试标准 Standard	单位 Unit	CSB-EPB26
颜色 Color	-	-	米色 Beige
密度 Density	ISO1183	g/cm ³	1.51
最大吸湿率 Max. moisture absorption, 50%RH	ISO62	%	0.1
最大吸水率 Max. water absorption	ISO62	%	0.2
对钢动摩擦系数 Coefficient of sliding friction(steel)	ITS025	μ	0.15-0.20
极限PV值 Max. PV value	ITS026	N/mm ² × m/s	0.50
弯曲模量 Flexural modulus	ISO178	MPa	4500
弯曲强度 Flexural strength	ISO178	MPa	95
最大静载荷 Max. static load	ITS027	MPa	55
最大动载荷 Max. dynamic load	ITS028	MPa	22
邵氏硬度 Shore hardness	ISO868	D	74
连续运行温度 Long-term application temperature	ITS029	°C	+200
短时运行温度 Short-term application temperature	ITS029	°C	+240
最低运行温度 Lowest application temperature	ITS029	°C	-40
导热性 Thermal conductivity	ISO22007	W/m/K	0.24
线性热膨胀系数 Coefficient of thermal expansion	ISO11359	K ⁻¹ × 10 ⁻⁵	3
阻燃等级 Flammability	UL94	Class	V0
体电阻率 Volume resistance	IEC60093	Ω · cm	>10 ¹²
面电阻率 Surface resistance	IEC60093	Ω	>10 ¹²

*ITS: CSB内部测试标准 CSB company's internal test standards.

**除非特殊说明测试温度为23℃ Test temperatures are 23℃ unless otherwise stated.

轴承PV值 PV value

CSB-EPB26塑料轴承最大运行PV值0.5N/mm² × m/s; 由此决定轴承所承受的载荷与速度成反比, 详细查阅图表EPB26-1。

The max PV value of the CSB-EPB26 plastic bearings is 0.5N/mm² × m/s which determines the load capacity of bearing is inversely proportional to the speed. Please refer to the chart for more detailed information (Graph EPB26-1).

■ PV图表 Permissible PV value for CSB-EPB26

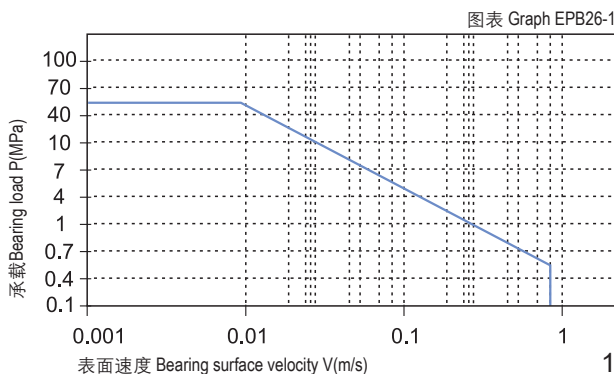

轴承的载荷、速度、温度 Load, speed and temperature

CSB-EPB26塑料轴承可承受最大静载荷为55Mpa，在此载荷下轴承的最大压缩变形量参考图表EPB26-2，轴承实际工作载荷略小于55Mpa，载荷还受到运行速度以及温度的影响，速度越快 (Vmax: 0.9m/s) 会导致摩擦温度上升，而温度上升 (Tmax: 200℃) 会导致轴承的承载能力逐渐减弱，载荷随轴承工作温度变化情况参考图表EPB26-3。

CSB-EPB26 allows the Max static load of 55Mpa, The max compressive deformation rate under the max load is listed in Graph EPB26-1, The actual load capacity of bearing is slightly less than 55Mpa, The bearing load is variable against the speed and temperature, Fast speed (Vmax: 0.9m/s) results into higher temperature (Tmax: 200℃) which decreases the load capacity of the bearing. Please refer to the Graph EPB26-3 for such variation.

轴承的摩擦系数、磨损、轴材料 Friction factor, wear and shaft material

摩擦系数 Friction factor

图表EPB26-4表明CSB-EPB26塑料轴承的摩擦系数在载荷保持不变的情况下受运行速度的增加影响相对较小；图表EPB26-5表明CSB-EPB26塑料轴承在保持速度不变的情况下，载荷从0增加到45Mpa过程中摩擦系数会逐步降低。图表EPB26-6表明CSB-EPB26塑料轴承的摩擦系数会随着轴表面粗糙度的增大而逐渐升高，我们推荐合适的轴粗糙度为Ra0.1 ~ 0.6um。

Graph EPB26-4 shows the friction factor of CSB-EPB26 is not obviously effected by the operation speed when the loading is stable and Graph EPB26-5 shows it will be decreasing along with the loading is increased from 0 to 45 Mpa when the operation speed is unchanged. The friction factor of CSB-EPB26 is increased along with the increasing of the shaft roughness. The recommended shaft roughness is Ra0.1 to Ra0.6.

摩擦系数与轴表面粗糙度关系图表 Coefficient of friction & the surface roughness of shaft

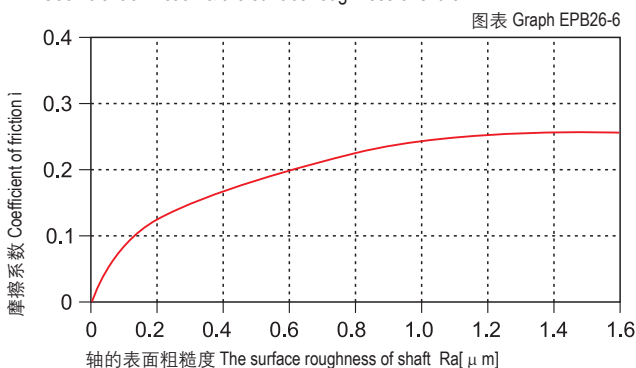

载荷-温度-变形量图表 Load-Temperature deformation

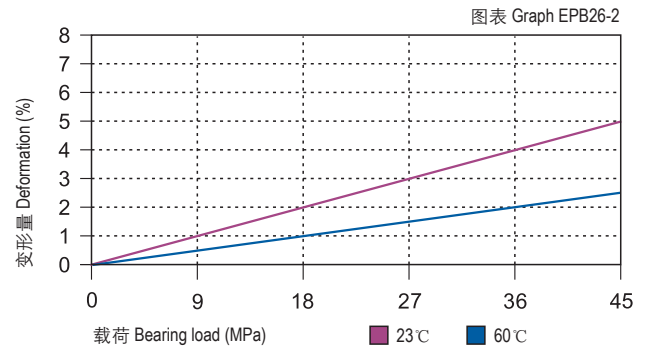

载荷-温度图表 Load-Temperature diagrams

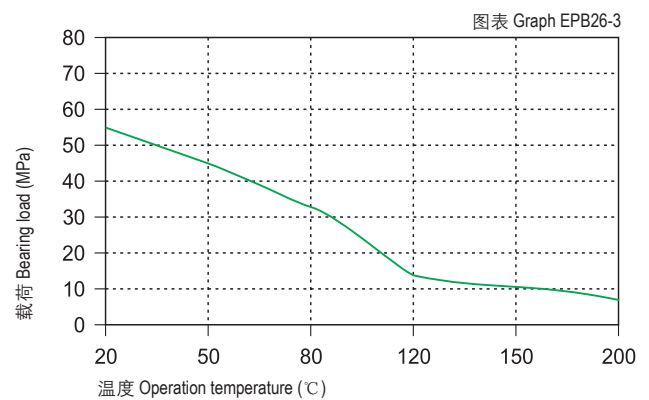

摩擦系数与速度变化关系图表 P=2MPa Coefficient of friction & the speed of bearing, p = 2 MPa

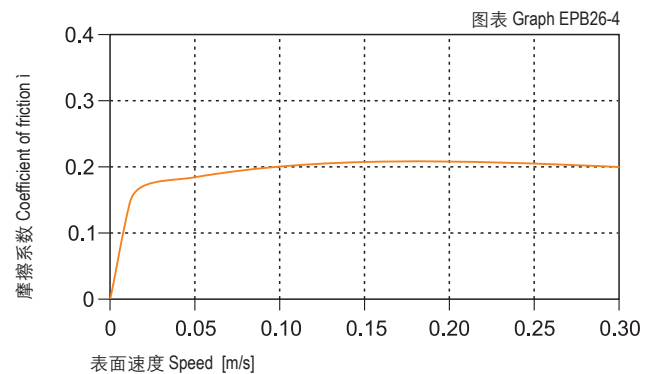

摩擦系数与载荷变化关系图表 v=0.2m/s Coefficient of friction & the pressure of bearing, v = 0.2 m/s

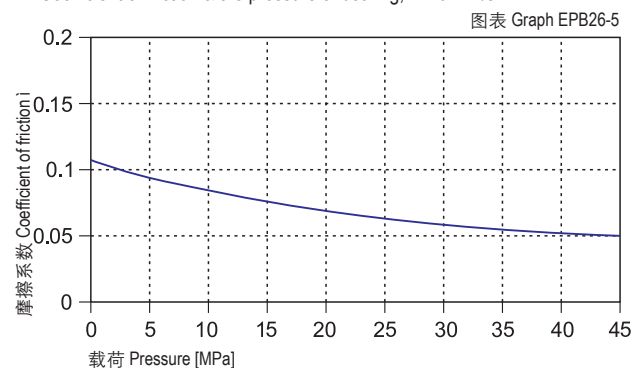

CSB-EPB26	干运行 Dry	油脂 Grease	油 Oil	水 Water
摩擦系数 μ Friction coef.	0.15~0.20	0.09	0.04	0.04

磨损与轴材料 Wearing and shaft material

图表EPB26-7与图表EPB26-8表明CSB-EPB26塑料轴承同时适用于硬质轴或软轴，在硬化钢轴和不锈钢轴上运行同样出色；但是硬化铝轴不适合用于CSB-EPB26塑料轴承。CSB-EPB26塑料轴承在做旋转运动下的磨损要略好于摆动运动下的磨损。

Graph EPB26-7 and Graph EPB26-8 tells that the CSB-EPB26 is very good for Hardened shaft and soft shaft and it features excellent both on hardened steel shaft and stainless steel shaft but the hardened aluminum shaft is not good for CSB-EPB26 bearings. The wear of CSB-EPB26 is better on rotation operation than on oscillation operation.

化学抗性 Chemical resistance

CSB-EPB26塑料轴承具有很好的化学抗性，能抵抗绝大多数酸碱。
The Chemical Resistance of CSB-EPB26 is fairly good against most of Acid and Alkalis.

吸水性 Water absorption

CSB-EPB26塑料轴承在标准大气中的吸湿率为0.1%。浸泡在水中的最高吸水率为0.2%。极低吸水率不会导致轴承发生性能变化和尺寸变化，非常适合用于潮湿环境。

The moisture absorption of CSB-EPB26 plastic plain bearings is 0.1% in standard atmosphere. The max. water absorption is 0.2% in water. These values are very low, CSB-EPB26 plastic plain bearings is very well suited for used in wet applications.

抗UV性能 UV resistance

CSB-EPB26塑料轴承长久暴露在紫外线下材料表面会发生蜕变，抗压强度会下降。

Disintegration could be possible for the material CSB-EPB26 after long period of exposing under the UV ray and therefore the compressive strength will be reduced.

安装公差 Installation tolerances

CSB-EPB26塑料轴承压装后公差 Tolerances after pressfit

直径 Di. [mm]	CSB-EPB26 E10 [mm]	座孔 Housing H7 [mm]	轴 Shaft h9 [mm]
>0 ~ 3	+0.014 ~ +0.054	0 ~ +0.010	0 ~ -0.025
>3 ~ 6	+0.020 ~ +0.068	0 ~ +0.012	0 ~ -0.030
>6 ~ 10	+0.025 ~ +0.083	0 ~ +0.015	0 ~ -0.036
>10 ~ 18	+0.032 ~ +0.102	0 ~ +0.018	0 ~ -0.043

在不同轴材料上旋转时的磨损量 $p=2\text{MPa}$, $v=0.2\text{m/s}$ Wear under rotating with different shaft materials, $p = 2 \text{ MPa}$, $v = 0.2 \text{ m/s}$

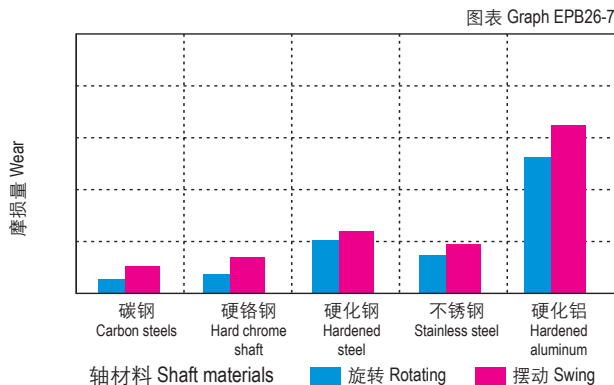

旋转磨损随轴材料与压力变化关系 $v=0.2\text{m/s}$ Wear & pressure under rotating with different shaft materials, $v = 0.2 \text{ m/s}$

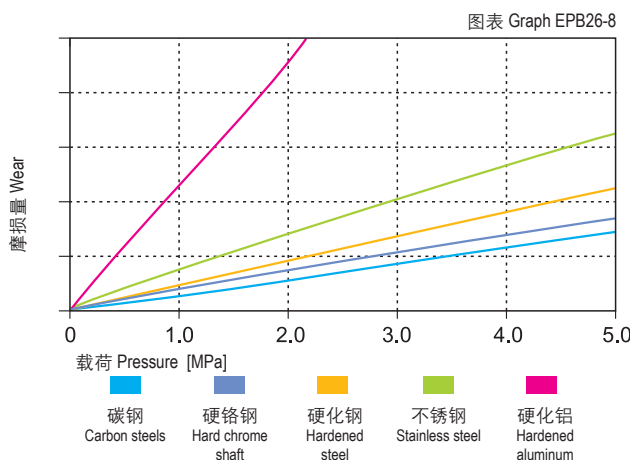

吸水性的影响 Effect of moisture absorption on EPB26 bearings

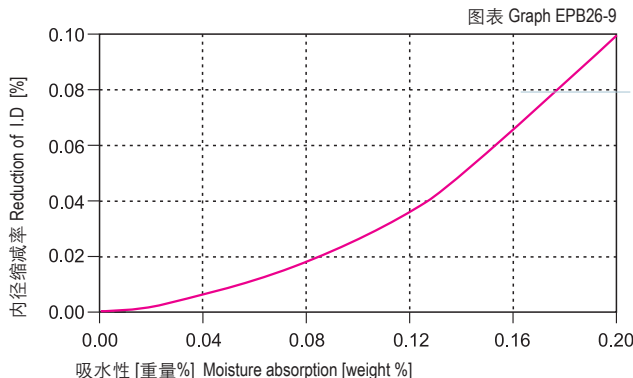

直径 Di. [mm]	CSB-EPB26 E10 [mm]	座孔 Housing H7 [mm]	轴 Shaft h9 [mm]
>18 ~ 30	+0.040 ~ +0.124	0 ~ +0.021	0 ~ -0.052
>30 ~ 50	+0.050 ~ +0.150	0 ~ +0.025	0 ~ -0.062
>50 ~ 80	+0.060 ~ +0.180	0 ~ +0.030	0 ~ -0.074

CSB-EPB® Standard Specifications

EPB\EPBH\EPB1\EPB2\EPB2D\EPB6\EPB6A\EPB13\EPB18 标准规格

直套 Metric cylindrical bushings

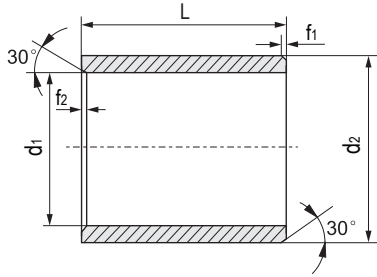

推荐安装公差 Recommend fitting tolerance:

座孔 Housing: H7

轴 Shaft: h9

产品编码 Part No.:

EPB -0608-06

d₁ d₂ L

材料 Material

d ₁	f ₁	f ₂
1-6	0.3	0.5
6-12	0.5	
12-30	0.8	
>30	1.2	

产品编码 Part No.	d ₁ [mm]	d ₁ -公差 After fitting [mm]	d ₂ [mm]	L(h13) [mm]
EPB-0203-03	2	+0.014/+0.054	3.5	3
EPB-0304-03	3	+0.014/+0.054	4.5	3
EPB-0304-036	3	+0.014/+0.054	4.5	3.6
EPB-0304-05	3	+0.014/+0.054	4.5	5
EPB-0304-055	3	+0.014/+0.054	4.5	5.5
EPB-0304-06	3	+0.014/+0.054	4.5	6
EPB-0405-04	4	+0.020/+0.068	5.5	4
EPB-0405-05	4	+0.020/+0.068	5.5	5
EPB-0405-06	4	+0.020/+0.068	5.5	6
EPB-0405-08	4	+0.020/+0.068	5.5	8
EPB-0405-10	4	+0.020/+0.068	5.5	10
EPB-0506-05	5	+0.010/+0.040	6	5
EPB-0506-07	5	+0.010/+0.040	6	7
EPB-0507-05	5	+0.020/+0.068	7	5
EPB-0507-08	5	+0.020/+0.068	7	8
EPB-0507-10	5	+0.020/+0.068	7	10
EPB-0608-04	6	+0.020/+0.068	8	4
EPB-0608-05	6	+0.020/+0.068	8	5
EPB-0608-06	6	+0.020/+0.068	8	6
EPB-0608-08	6	+0.020/+0.068	8	8
EPB-0608-10	6	+0.020/+0.068	8	10
EPB-0608-11	6	+0.020/+0.068	8	11
EPB-0810-05	8	+0.025/+0.083	10	5
EPB-0810-06	8	+0.025/+0.083	10	6
EPB-0810-08	8	+0.025/+0.083	10	8
EPB-0810-10	8	+0.025/+0.083	10	10
EPB-0810-11	8	+0.025/+0.083	10	11
EPB-0810-12	8	+0.025/+0.083	10	12
EPB-0810-15	8	+0.025/+0.083	10	15
EPB-0811-10	8	+0.025/+0.083	11	10
EPB-0812-10	8	+0.025/+0.083	12	10
EPB-0911-06	9	+0.025/+0.083	11	6
EPB-1012-04	10	+0.025/+0.083	12	4
EPB-1012-05	10	+0.025/+0.083	12	5
EPB-1012-06	10	+0.025/+0.083	12	6

产品编码 Part No.	d ₁ [mm]	d ₁ -公差 After fitting [mm]	d ₂ [mm]	L(h13) [mm]
EPB-1012-08	10	+0.025/+0.083	12	8
EPB-1012-10	10	+0.025/+0.083	12	10
EPB-1012-12	10	+0.025/+0.083	12	12
EPB-1012-15	10	+0.025/+0.083	12	15
EPB-1014-10	10	+0.025/+0.083	14	10
EPB-1014-16	10	+0.025/+0.083	14	16
EPB-1012-18	10	+0.025/+0.083	12	18
EPB-1012-20	10	+0.025/+0.083	12	20
EPB-1214-06	12	+0.032/+0.102	14	6
EPB-1214-08	12	+0.032/+0.102	14	8
EPB-1214-10	12	+0.032/+0.102	14	10
EPB-1214-12	12	+0.032/+0.102	14	12
EPB-1214-15	12	+0.032/+0.102	14	15
EPB-1214-20	12	+0.032/+0.102	14	20
EPB-1214-25	12	+0.032/+0.102	14	25
EPB-1214-30	12	+0.032/+0.102	14	30
EPB-1215-20	12	+0.032/+0.102	15	20
EPB-1216-12	12	+0.032/+0.102	16	12
EPB-1315-07	13	+0.032/+0.102	15	7
EPB-1315-10	13	+0.032/+0.102	15	10
EPB-1416-08	14	+0.032/+0.102	16	8
EPB-1416-10	14	+0.032/+0.102	16	10
EPB-1416-12	14	+0.032/+0.102	16	12
EPB-1416-15	14	+0.032/+0.102	16	15
EPB-1416-20	14	+0.032/+0.102	16	20
EPB-1416-25	14	+0.032/+0.102	16	25
EPB-1517-10	15	+0.032/+0.102	17	10
EPB-1517-12	15	+0.032/+0.102	17	12
EPB-1517-15	15	+0.032/+0.102	17	15
EPB-1517-17	15	+0.032/+0.102	17	17
EPB-1517-20	15	+0.032/+0.102	17	20
EPB-1517-25	15	+0.032/+0.102	17	25
EPB-1618-10	16	+0.032/+0.102	18	10
EPB-1618-12	16	+0.032/+0.102	18	12
EPB-1618-15	16	+0.032/+0.102	18	15

EPB

CSB-EPB®

www.csb-ep.com
sales@csb-ep.com

Tel: 0086 573 84186133/84185527
Fax: 0086 573 84185517

产品编码 Part No.	d ₁ [mm]	d ₁ -公差 After fitting [mm]	d ₂ [mm]	L(h13) [mm]
EPB-1618-20	16	+0.032/+0.102	18	20
EPB-1618-25	16	+0.032/+0.102	18	25
EPB-1619-5.5S	16	+0.015/+0.055	19	5.5
EPB-1620-16	16	+0.032/+0.102	20	16
EPB-1820-15	18	+0.032/+0.102	20	15
EPB-1820-20	18	+0.032/+0.102	20	20
EPB-1820-25	18	+0.032/+0.102	20	25
EPB-2022-12	20	+0.040/+0.124	22	12
EPB-2022-15	20	+0.040/+0.124	22	15
EPB-2022-28	20	+0.040/+0.124	22	28
EPB-2023-10	20	+0.040/+0.124	23	10
EPB-2023-15	20	+0.040/+0.124	23	15
EPB-2023-20	20	+0.040/+0.124	23	20
EPB-2023-23	20	+0.040/+0.124	23	23
EPB-2023-25	20	+0.040/+0.124	23	25
EPB-2023-30	20	+0.040/+0.124	23	30
EPB-2025-15	20	+0.040/+0.124	25	15
EPB-2225-15	22	+0.040/+0.124	25	15
EPB-2225-20	22	+0.040/+0.124	25	20
EPB-2225-25	22	+0.040/+0.124	25	25
EPB-2225-30	22	+0.040/+0.124	25	30
EPB-2528-10	25	+0.040/+0.124	28	10
EPB-2528-12	25	+0.040/+0.124	28	12
EPB-2528-15	25	+0.040/+0.124	28	15
EPB-2528-20	25	+0.040/+0.124	28	20
EPB-2528-25	25	+0.040/+0.124	28	25
EPB-2528-30	25	+0.040/+0.124	28	30
EPB-2529-25	25	+0.040/+0.124	29	25
EPB-2530-25	25	+0.020/+0.104	30	25
EPB-2832-20	28	+0.040/+0.124	32	20
EPB-2832-25	28	+0.040/+0.124	32	25
EPB-2832-30	28	+0.040/+0.124	32	30
EPB-3034-20	30	+0.040/+0.124	34	20
EPB-3034-25	30	+0.040/+0.124	34	25

产品编码 Part No.	d ₁ [mm]	d ₁ -公差 After fitting [mm]	d ₂ [mm]	L(h13) [mm]
EPB-3034-30	30	+0.040/+0.124	34	30
EPB-3034-40	30	+0.040/+0.124	34	40
EPB-3236-20	32	+0.050/+0.150	36	20
EPB-3236-23	32	+0.050/+0.150	36	23
EPB-3236-25	32	+0.050/+0.150	36	25
EPB-3236-30	32	+0.050/+0.150	36	30
EPB-3236-40	32	+0.050/+0.150	36	40
EPB-3539-15	35	+0.050/+0.150	39	15
EPB-3539-20	35	+0.050/+0.150	39	20
EPB-3539-25	35	+0.050/+0.150	39	25
EPB-3539-30	35	+0.050/+0.150	39	30
EPB-3539-40	35	+0.050/+0.150	39	40
EPB-3539-50	35	+0.050/+0.150	39	50
EPB-4044-20	40	+0.050/+0.150	44	20
EPB-4044-30	40	+0.050/+0.150	44	30
EPB-4044-40	40	+0.050/+0.150	44	40
EPB-4044-50	40	+0.050/+0.150	44	50
EPB-4550-30	45	+0.050/+0.150	50	30
EPB-4550-40	45	+0.050/+0.150	50	40
EPB-4550-50	45	+0.050/+0.150	50	50
EPB-5055-10	50	+0.050/+0.150	55	10
EPB-5055-20	50	+0.050/+0.150	55	20
EPB-5055-30	50	+0.050/+0.150	55	30
EPB-5055-40	50	+0.050/+0.150	55	40
EPB-5055-50	50	+0.050/+0.150	55	50
EPB-5456-30	54	+0.060/+0.180	56	30
EPB-6065-50	60	+0.060/+0.180	65	50
EPB-7075-50	70	+0.060/+0.180	75	50
EPB-8085-40	80	+0.060/+0.180	85	40
EPB-8590-40	85	+0.072/+0.212	90	40
EPB-125130-60	125	+0.043/+0.143	130	60
EPB-150155-60	150	+0.043/+0.143	155	60

*d₁公差为压入标准H7座孔（符合ISO3547-1）后公差
*Tolerance d₁ after fitting into housing H7 (ISO3547-1)

法兰轴承 Metric flange bushings

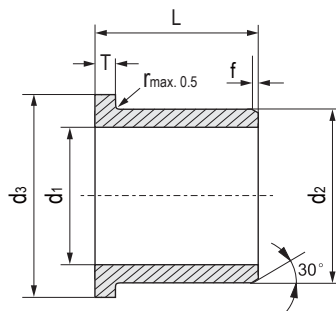

推荐安装公差 Recommend fitting tolerance:

座孔 Housing: H7

轴 Shaft: h9

产品编码 Part No.:

EPB F-0608-06

法兰轴承 Flange bushes

材料 Material

d ₁	f
1-6	0.3
6-12	0.5
12-30	0.8
>30	1.2

CSB-EPB[®] Standard Specifications

EPB\EPBH\EPB1\EPB2\EPB2D\EPB6\EPB6A\EPB13\EPB18 标准规格

产品编码 Part No.	d ₁ [mm]	d ₁ -公差 After fitting [mm]	d ₂ [mm]	d ₃ [d13] [mm]	L[h13] [mm]	T _{0.14} [mm]
EPBF-0304-03	3	+0.014/+0.054	4.5	7.5	3	0.75
EPBF-0304-05	3	+0.014/+0.054	4.5	7.5	5	0.75
EPBF-0405-03	4	+0.020/+0.068	5.5	9.5	3	0.75
EPBF-0405-04	4	+0.020/+0.068	5.5	9.5	4	0.75
EPBF-0405-06	4	+0.020/+0.068	5.5	9.5	6	0.75
EPBF-0506-035	5	+0.010/+0.040	6	10	3.5	0.5
EPBF-0506-05	5	+0.010/+0.040	6	10	5	0.5
EPBF-0506-06	5	+0.010/+0.040	6	10	6	0.5
EPBF-0507-04	5	+0.020/+0.068	7	11	4	1
EPBF-0507-05	5	+0.020/+0.068	7	11	5	1
EPBF-0507-10	5	+0.020/+0.068	7	11	10	1
EPBF-0608-04	6	+0.020/+0.068	8	12	4	1
EPBF-0608-05	6	+0.020/+0.068	8	12	5	1
EPBF-0608-06	6	+0.020/+0.068	8	12	6	1
EPBF-0608-08	6	+0.020/+0.068	8	12	8	1
EPBF-0608-10	6	+0.020/+0.068	8	12	10	1
EPBF-0810-055	8	+0.025/+0.083	10	15	5.5	1
EPBF-0810-06	8	+0.025/+0.083	10	15	6	1
EPBF-0810-075	8	+0.025/+0.083	10	15	7.5	1
EPBF-0810-095	8	+0.025/+0.083	10	15	9.5	1
EPBF-0810-10	8	+0.025/+0.083	10	15	10	1
EPBF-081014-12	8	+0.025/+0.083	10	14	12	1
EPBF-081014-12F2	8	+0.025/+0.083	10	14	12	2
EPBF-0810-12	8	+0.025/+0.083	10	15	12	1
EPBF-081018-13	8	+0.025/+0.083	10	18	13	1
EPBF-081017-15	8	+0.025/+0.083	10	17	15	1
EPBF-081216-10	8	+0.013/+0.071	12	16	10	2
EPBF-0912-10	9	+0.025/+0.083	12	18	10	2
EPBF-1012-05	10	+0.025/+0.083	12	18	5	1
EPBF-1012-06	10	+0.025/+0.083	12	18	6	1
EPBF-1012-07	10	+0.025/+0.083	12	18	7	1
EPBF-1012-08	10	+0.025/+0.083	12	18	8	1
EPBF-1012-09	10	+0.025/+0.083	12	18	9	1
EPBF-1012-10	10	+0.025/+0.083	12	18	10	1
EPBF-1012-12	10	+0.025/+0.083	12	18	12	1
EPBF-1012-15	10	+0.025/+0.083	12	18	15	1
EPBF-1012-17	10	+0.025/+0.083	12	18	17	1
EPBF-101216-12	10	+0.013/+0.071	12	16	12	2
EPBF-101418-10	10	+0.013/+0.071	14	18	10	2
EPBF-1214-04	12	+0.032/+0.102	14	20	4	1
EPBF-1214-05	12	+0.032/+0.102	14	20	5	1
EPBF-1214-06	12	+0.032/+0.102	14	20	6	1
EPBF-1214-07	12	+0.032/+0.102	14	20	7	1
EPBF-1214-09	12	+0.032/+0.102	14	20	9	1
EPBF-1214-10	12	+0.032/+0.102	14	20	10	1
EPBF-1214-12	12	+0.032/+0.102	14	20	12	1
EPBF-1214-13	12	+0.032/+0.102	14	20	13	1
EPBF-1214-15	12	+0.032/+0.102	14	20	15	1
EPBF-1214-17	12	+0.032/+0.102	14	20	17	1
EPBF-1214-18	12	+0.032/+0.102	14	20	18	1
EPBF-1214-20	12	+0.032/+0.102	14	20	20	1
EPBF-121417-04	12	+0.032/+0.102	14	17	4	1
EPBF-121417-05	12	+0.032/+0.102	14	17	5	1
EPBF-121418-12F2	12	+0.016/+0.086	14	18	12	2

产品编码 Part No.	d ₁ [mm]	d ₁ -公差 After fitting [mm]	d ₂ [mm]	d ₃ [d13] [mm]	L[h13] [mm]	T _{0.14} [mm]
EPBF-121418-25	12	+0.032/+0.102	14	18	25	1
EPBF-121418-40F2	12	+0.016/+0.086	14	18	40	2
EPBF-121620-10	12	+0.016/+0.086	16	20	10	2
EPBF-121620-12	12	+0.016/+0.086	16	20	12	2
EPBF-131519-12	13	+0.032/+0.102	15	19	12	1
EPBF-131520-05	13	+0.032/+0.102	15	20	5	1
EPBF-1416-052	14	+0.032/+0.102	16	22	5.2	1
EPBF-1416-08	14	+0.032/+0.102	16	22	8	1
EPBF-1416-10	14	+0.032/+0.102	16	22	10	1
EPBF-1416-12	14	+0.032/+0.102	16	22	12	1
EPBF-1416-17	14	+0.032/+0.102	16	22	17	1
EPBF-141620-06	14	+0.016/+0.086	16	20	6	2
EPBF-141620-15	14	+0.016/+0.086	16	20	15	2
EPBF-141822-20	14	+0.032/+0.102	18	22	20	2
EPBF-151720-05	15	+0.032/+0.102	17	20	5	1
EPBF-1517-09	15	+0.032/+0.102	17	23	9	1
EPBF-1517-12	15	+0.032/+0.102	17	23	12	1
EPBF-151720-12	15	+0.032/+0.102	17	20	12	1
EPBF-1517-15	15	+0.032/+0.102	17	23	15	1
EPBF-1517-17	15	+0.032/+0.102	17	23	17	1
EPBF-1517-20	15	+0.032/+0.102	17	23	20	1
EPBF-1517-25	15	+0.032/+0.102	17	23	25	1
EPBF-1518-12	15	+0.032/+0.102	18	23	12	1
EPBF-1618-09	16	+0.032/+0.102	18	24	9	1
EPBF-1618-12	16	+0.032/+0.102	18	24	12	1
EPBF-1618-17	16	+0.032/+0.102	18	24	17	1
EPBF-161822-22	16	+0.016/+0.086	18	22	22	2
EPBF-162024-16	16	+0.016/+0.086	20	24	16	2
EPBF-162024-22	16	+0.016/+0.086	20	24	22	2
EPBF-1820-12	18	+0.032/+0.102	20	26	12	1
EPBF-1820-17	18	+0.032/+0.102	20	26	17	1
EPBF-1820-20	18	+0.032/+0.102	20	26	20	1
EPBF-182024-22	18	+0.016/+0.086	20	24	22	2
EPBF-1922-23	19	+0.040/+0.124	22	26	23	1
EPBF-2022-15	20	+0.040/+0.124	22	25	15	1.5
EPBF-2023-11.5	20	+0.040/+0.124	23	30	11.5	1.5
EPBF-2023-16.5	20	+0.040/+0.124	23	30	16.5	1.5
EPBF-2023-21.5	20	+0.040/+0.124	23	30	21.5	1.5
EPBF-2023-25	20	+0.040/+0.124	23	30	25	1.5
EPBF-202330-15	20	+0.020/+0.104	23	30	15	2
EPBF-202330-22	20	+0.020/+0.104	23	30	22	2
EPBF-202430-20	20	+0.020/+0.104	24	30	20	2
EPBF-202530-15	20	+0.020/+0.104	25	30	15	2
EPBF-202732-20	20	+0.020/+0.104	27	32	20	2
EPBF-2225-11.5	22	+0.040/+0.124	25	33	11.5	1.5
EPBF-2528-11.5	25	+0.040/+0.124	28	35	11.5	1.5
EPBF-2528-16.5	25	+0.040/+0.124	28	35	16.5	1.5
EPBF-2528-21.5	25	+0.040/+0.124	28	35	21.5	1.5
EPBF-252835-22	25	+0.020/+0.104	28	35	22	2
EPBF-252835-32	25	+0.020/+0.104	28	35	32	2
EPBF-253035-20	25	+0.020/+0.104	30	35	20	2.5
EPBF-253035-25	25	+0.020/+0.104	30	35	25	2.5
EPBF-303335-04	30	+0.020/+0.104	33	35	4	1
EPBF-3034-09	30	+0.040/+0.124	34	42	9	2

EPB

CSB-EPB[®]

www.csb-ep.com
sales@csb-ep.com

Tel: 0086 573 84186133/84185527
Fax: 0086 573 84185517

产品编码 Part No.	d ₁ [mm]	d ₁ -公差 After fitting [mm]	d ₂ [mm]	d ₃ [d13] [mm]	L[h13] [mm]	T _{0.14} [mm]
EPBF-3034-16	30	+0.040/+0.124	34	42	16	2
EPBF-3034-26	30	+0.040/+0.124	34	42	26	2
EPBF-3034-32	30	+0.040/+0.124	34	42	32	2
EPBF-3034-37	30	+0.040/+0.124	34	42	37	2
EPBF-303445-18	30	+0.020/+0.104	34	45	18	2
EPBF-303445-22	30	+0.020/+0.104	34	45	22	2
EPBF-303445-32	30	+0.040/+0.124	34	45	32	2
EPBF-3236-16	32	+0.050/+0.150	36	40	16	2
EPBF-3236-26	32	+0.050/+0.150	36	40	26	2
EPBF-3539-16	35	+0.050/+0.150	39	47	16	2
EPBF-3539-26	35	+0.050/+0.150	39	47	26	2
EPBF-353950-22	35	+0.025/+0.125	39	50	22	2
EPBF-4044-30	40	+0.050/+0.150	44	52	30	2
EPBF-4044-40	40	+0.050/+0.150	44	52	40	2
EPBF-404455-17	40	+0.025/+0.125	44	55	17	2
EPBF-4550-25	45	+0.050/+0.150	50	58	25	2
EPBF-4550-45	45	+0.050/+0.150	50	58	45	2
EPBF-4550-50	45	+0.050/+0.150	50	58	50	2

产品编码 Part No.	d ₁ [mm]	d ₁ -公差 After fitting [mm]	d ₂ [mm]	d ₃ [d13] [mm]	L[h13] [mm]	T _{0.14} [mm]
EPBF-455060-45	45	+0.025/+0.125	50	60	45	2.5
EPBF-5055-20	50	+0.050/+0.150	55	63	20	2
EPBF-5055-30	50	+0.050/+0.150	55	63	30	2
EPBF-5055-40	50	+0.050/+0.150	55	63	40	2
EPBF-5055-50	50	+0.050/+0.150	55	63	50	2
EPBF-505563-50	50	+0.025/+0.125	55	63	50	2
EPBF-505565-20.5	50	+0.025/+0.125	55	65	20.5	2.5
EPBF-6065-50	60	+0.060/+0.180	65	73	50	2
EPBF-6065-60	60	+0.030/+0.150	65	73	60	2
EPBF-657080-60	65	+0.030/+0.150	70	80	60	2.5
EPBF-7075-50	70	+0.060/+0.180	75	83	50	2
EPBF-758090-25	75	+0.030/+0.150	80	90	25	2.5
EPBF-758090-40	75	+0.030/+0.150	80	90	40	2.5
EPBF-9095110-50	90	+0.036/+0.176	95	110	50	2.5
EPBF-120125140-50	120	+0.072/+0.212	125	140	50	2.5

*d₁公差为压入标准H7座孔（符合ISO3547-1）后公差
*Tolerance d₁ after fitting into housing H7 (ISO3547-1)

垫片 Metric thrust washers

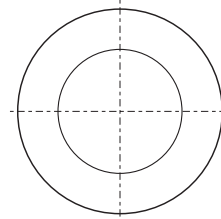
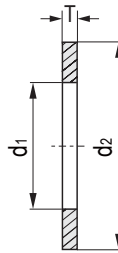

产品编码 Part No.:

EPBW-0818-015

d₁ d₂ T

垫片 Washer

材料 Material

产品编码 Part No.	d ₁ ^{+0.25} [mm]	d ₂ ^{-0.25} [mm]	T _{0.05} [mm]
EPBW-0509-006	5	9	0.6
EPBW-0615-015	6	15	1.5
EPBW-0620-015	6	20	1.5
EPBW-0815-005	8	15	0.5
EPBW-0815-015	8	15	1.5
EPBW-0818-010	8	18	1.0
EPBW-0818-015	8	18	1.5
EPBW-1018-010	10	18	1.0
EPBW-1018-015	10	18	1.5
EPBW-1018-020	10	18	2.0
EPBW-1024-015	10	24	1.5
EPBW-1224-015	12	24	1.5
EPBW-1226-015	12	26	1.5
EPBW-1426-015	14	26	1.5
EPBW-1430-015	14	30	1.5
EPBW-1524-015	15	24	1.5
EPBW-1630-015	16	30	1.5
EPBW-1632-015	16	32	1.5
EPBW-1832-015	18	32	1.5
EPBW-1836-015	18	36	1.5

产品编码 Part No.	d ₁ ^{+0.25} [mm]	d ₂ ^{-0.25} [mm]	T _{0.05} [mm]
EPBW-2028-030	20	28	3.0
EPBW-2030-015	20	30	1.5
EPBW-2036-015	20	36	1.5
EPBW-2038-015	20	38	1.5
EPBW-2238-015	22	38	1.5
EPBW-2242-015	22	42	1.5
EPBW-2442-015	24	42	1.5
EPBW-2444-015	24	44	1.5
EPBW-2644-015	26	44	1.5
EPBW-2848-015	28	48	1.5
EPBW-3054-015	30	54	1.5
EPBW-3254-015	32	54	1.5
EPBW-3662-015	36	62	1.5
EPBW-3862-015	38	62	1.5
EPBW-4266-015	42	66	1.5
EPBW-4674-020	46	74	2.0
EPBW-4874-020	48	74	2.0
EPBW-5178-020	51	78	2.0
EPBW-5278-020	52	78	2.0
EPBW-6290-020	62	90	2.0

*根据要求提供定位孔设计 The fixing bore design upon request.

CSB-EPB® Standard Specifications

EPB3\EPB3G\EPB9\EPB12\EPB16\EPB20\EPB21\EPB22\EPB26 标准规格

直套 Metric cylindrical bushings

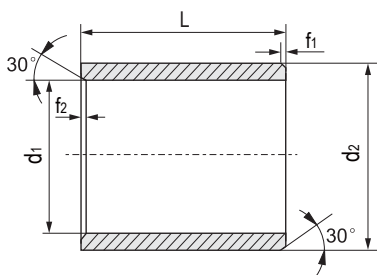

推荐安装公差 Recommend fitting tolerance:

座孔 Housing: H7

轴 Shaft: h9

产品编码 Part No.:

EPB3 -0608-06

d₁ d₂ L

材料 Material

d ₁	f ₁	f ₂
1-6	0.3	0.5
6-12	0.5	
12-30	0.8	
>30	1.2	

产品编码 Part No.	d ₁ [mm]	d ₁ -公差 After fitting [mm]	d ₂ [mm]	L(h13) [mm]
EPB3-0203-03	2	+0.014/+0.054	3.5	3
EPB3-0304-03	3	+0.014/+0.054	4.5	3
EPB3-0304-036	3	+0.014/+0.054	4.5	3.6
EPB3-0304-05	3	+0.014/+0.054	4.5	5
EPB3-0304-055	3	+0.014/+0.054	4.5	5.5
EPB3-0304-06	3	+0.014/+0.054	4.5	6
EPB3-0405-04	4	+0.020/+0.068	5.5	4
EPB3-0405-05	4	+0.020/+0.068	5.5	5
EPB3-0405-06	4	+0.020/+0.068	5.5	6
EPB3-0405-08	4	+0.020/+0.068	5.5	8
EPB3-0405-10	4	+0.020/+0.068	5.5	10
EPB3-0506-05	5	+0.010/+0.040	6	5
EPB3-0506-07	5	+0.010/+0.040	6	7
EPB3-0507-05	5	+0.020/+0.068	7	5
EPB3-0507-08	5	+0.020/+0.068	7	8
EPB3-0507-10	5	+0.020/+0.068	7	10
EPB3-0608-04	6	+0.020/+0.068	8	4
EPB3-0608-05	6	+0.020/+0.068	8	5
EPB3-0608-06	6	+0.020/+0.068	8	6
EPB3-0608-08	6	+0.020/+0.068	8	8
EPB3-0608-09	6	+0.020/+0.068	8	9
EPB3-0608-10	6	+0.020/+0.068	8	10
EPB3-0608-11	6	+0.020/+0.068	8	11
EPB3-0810-05	8	+0.025/+0.083	10	5
EPB3-0810-06	8	+0.025/+0.083	10	6
EPB3-0810-07	8	+0.025/+0.083	10	7
EPB3-0810-08	8	+0.025/+0.083	10	8
EPB3-0810-10	8	+0.025/+0.083	10	10
EPB3-0810-12	8	+0.025/+0.083	10	12
EPB3-0810-13	8	+0.025/+0.083	10	13
EPB3-0810-15	8	+0.025/+0.083	10	15
EPB3-0810-21	8	+0.025/+0.083	10	21
EPB3-1011-06	10	+0.025/+0.083	11	6
EPB3-1012-04	10	+0.025/+0.083	12	4
EPB3-1012-05	10	+0.025/+0.083	12	5
EPB3-1012-06	10	+0.025/+0.083	12	6
EPB3-1012-07	10	+0.025/+0.083	12	7
EPB3-1012-08	10	+0.025/+0.083	12	8

产品编码 Part No.	d ₁ [mm]	d ₁ -公差 After fitting [mm]	d ₂ [mm]	L(h13) [mm]
EPB3-1012-09	10	+0.025/+0.083	12	9
EPB3-1012-10	10	+0.025/+0.083	12	10
EPB3-1012-12	10	+0.025/+0.083	12	12
EPB3-1012-14	10	+0.025/+0.083	12	14
EPB3-1012-15	10	+0.025/+0.083	12	15
EPB3-1012-17	10	+0.025/+0.083	12	17
EPB3-1012-20	10	+0.025/+0.083	12	20
EPB3-1213-12	12	+0.016/+0.059	13	12
EPB3-1214-04	12	+0.032/+0.102	14	4
EPB3-1214-06	12	+0.032/+0.102	14	6
EPB3-1214-08	12	+0.032/+0.102	14	8
EPB3-1214-10	12	+0.032/+0.102	14	10
EPB3-1214-12	12	+0.032/+0.102	14	12
EPB3-1214-14	12	+0.032/+0.102	14	14
EPB3-1214-15	12	+0.032/+0.102	14	15
EPB3-1214-20	12	+0.032/+0.102	14	20
EPB3-1214-25	12	+0.032/+0.102	14	25
EPB3-1315-15	13	+0.032/+0.102	15	15
EPB3-1315-25	13	+0.032/+0.102	15	25
EPB3-1416-03	14	+0.032/+0.102	16	3
EPB3-1416-08	14	+0.032/+0.102	16	8
EPB3-1416-10	14	+0.032/+0.102	16	10
EPB3-1416-15	14	+0.032/+0.102	16	15
EPB3-1416-20	14	+0.032/+0.102	16	20
EPB3-1416-25	14	+0.032/+0.102	16	25
EPB3-1517-10	15	+0.032/+0.102	17	10
EPB3-1517-12	15	+0.032/+0.102	17	12
EPB3-1517-15	15	+0.032/+0.102	17	15
EPB3-1517-20	15	+0.032/+0.102	17	20
EPB3-1517-25	15	+0.032/+0.102	17	25
EPB3-1618-10	16	+0.032/+0.102	18	10
EPB3-1618-12	16	+0.032/+0.102	18	12
EPB3-1618-15	16	+0.032/+0.102	18	15
EPB3-1618-20	16	+0.032/+0.102	18	20
EPB3-1618-25	16	+0.032/+0.102	18	25
EPB3-1618-30	16	+0.032/+0.102	18	30
EPB3-1820-10	18	+0.032/+0.102	20	10
EPB3-1820-12	18	+0.032/+0.102	20	12

EPB

CSB-EPB®

www.csb-ep.com
sales@csb-ep.com

Tel: 0086 573 84186133/84185527
Fax: 0086 573 84185517

产品编码 Part No.	d ₁ [mm]	d ₁ -公差 After fitting [mm]	d ₂ [mm]	L(h13) [mm]
EPB3-1820-15	18	+0.032/+0.102	20	15
EPB3-1820-20	18	+0.032/+0.102	20	20
EPB3-1820-25	18	+0.032/+0.102	20	25
EPB3-2022-20	20	+0.040/+0.124	22	20
EPB3-2022-30	20	+0.040/+0.124	22	30
EPB3-2023-10	20	+0.040/+0.124	23	10
EPB3-2023-15	20	+0.040/+0.124	23	15
EPB3-2023-20	20	+0.040/+0.124	23	20
EPB3-2023-25	20	+0.040/+0.124	23	25
EPB3-2023-30	20	+0.040/+0.124	23	30
EPB3-2224-10	22	+0.040/+0.124	24	10
EPB3-2225-15	22	+0.040/+0.124	25	15
EPB3-2225-20	22	+0.040/+0.124	25	20
EPB3-2225-25	22	+0.040/+0.124	25	25
EPB3-2225-30	22	+0.040/+0.124	25	30
EPB3-2528-12	25	+0.040/+0.124	28	12
EPB3-2528-15	25	+0.040/+0.124	28	15
EPB3-2528-20	25	+0.040/+0.124	28	20
EPB3-2528-21	25	+0.040/+0.124	28	21
EPB3-2528-24	25	+0.040/+0.124	28	24
EPB3-2528-25	25	+0.040/+0.124	28	25
EPB3-2528-30	25	+0.040/+0.124	28	30
EPB3-2528-35	25	+0.040/+0.124	28	35
EPB3-2832-30	28	+0.040/+0.124	32	30
EPB3-3034-15	30	+0.040/+0.124	34	15
EPB3-3034-20	30	+0.040/+0.124	34	20
EPB3-3034-24	30	+0.040/+0.124	34	24
EPB3-3034-25	30	+0.040/+0.124	34	25
EPB3-3034-30	30	+0.040/+0.124	34	30
EPB3-3034-35	30	+0.040/+0.124	34	35
EPB3-3034-40	30	+0.040/+0.124	34	40
EPB3-3236-20	32	+0.050/+0.150	36	20
EPB3-3236-30	32	+0.050/+0.150	36	30
EPB3-3236-40	32	+0.050/+0.150	36	40
EPB3-3539-14	35	+0.050/+0.150	39	14
EPB3-3539-20	35	+0.050/+0.150	39	20

产品编码 Part No.	d ₁ [mm]	d ₁ -公差 After fitting [mm]	d ₂ [mm]	L(h13) [mm]
EPB3-3539-25	35	+0.050/+0.150	39	25
EPB3-3539-30	35	+0.050/+0.150	39	30
EPB3-3539-40	35	+0.050/+0.150	39	40
EPB3-3539-50	35	+0.050/+0.150	39	50
EPB3-3640-20	36	+0.050/+0.150	40	20
EPB3-4044-10	40	+0.050/+0.150	44	10
EPB3-4044-16	40	+0.050/+0.150	44	16
EPB3-4044-20	40	+0.050/+0.150	44	20
EPB3-4044-30	40	+0.050/+0.150	44	30
EPB3-4044-40	40	+0.050/+0.150	44	40
EPB3-4044-50	40	+0.050/+0.150	44	50
EPB3-4246-40	42	+0.050/+0.150	46	40
EPB3-4246-50	42	+0.050/+0.150	46	50
EPB3-4550-40	45	+0.050/+0.150	50	40
EPB3-4550-50	45	+0.050/+0.150	50	50
EPB3-5055-20	50	+0.050/+0.150	55	20
EPB3-5055-25	50	+0.050/+0.150	55	25
EPB3-5055-30	50	+0.050/+0.150	55	30
EPB3-5055-40	50	+0.050/+0.150	55	40
EPB3-5055-50	50	+0.050/+0.150	55	50
EPB3-5560-20	55	+0.060/+0.180	60	20
EPB3-5560-26	55	+0.060/+0.180	60	26
EPB3-5560-40	55	+0.060/+0.180	60	40
EPB3-5560-50	55	+0.060/+0.180	60	50
EPB3-5560-60	55	+0.060/+0.180	60	60
EPB3-6065-30	60	+0.060/+0.180	65	30
EPB3-6065-40	60	+0.060/+0.180	65	40
EPB3-6065-50	60	+0.060/+0.180	65	50
EPB3-6065-60	60	+0.060/+0.180	65	60
EPB3-6570-50	65	+0.060/+0.180	70	50
EPB3-7075-60	70	+0.060/+0.180	75	60
EPB3-7580-40	75	+0.060/+0.180	80	40
EPB3-115121-90	115	+0.072/+0.212	121	90
EPB3-120125-100	120	+0.072/+0.212	125	100

*d₁公差为压入标准H7座孔（符合ISO3547-1）后公差
 *Tolerance d₁ after fitting into housing H7 (ISO3547-1)

法兰轴承 Metric flange bushings

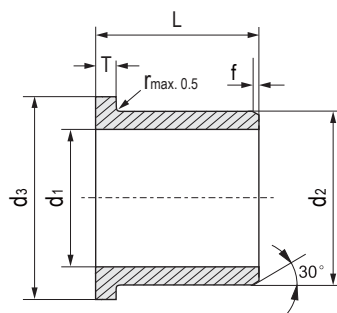

推荐安装公差 Recommend fitting tolerance:

座孔 Housing: H7

轴 Shaft: h9

产品编码 Part No.:

EPB3F-0608-06

|
|
|
|
|

法兰轴承 Flange bushes

材料 Material

d ₁	f
1-6	0.3
6-12	0.5
12-30	0.8
>30	1.2

CSB-EPB[®] Standard Specifications

EPB3\EPB3G\EPB9\EPB12\EPB16\EPB20\EPB21\EPB22\EPB26 标准规格

产品编码 Part No.	d ₁ [mm]	d ₁ -公差 After fitting [mm]	d ₂ [mm]	d ₃ [d13] [mm]	L[h13] [mm]	T _{0.14} [mm]
EPB3F-0304-03	3	+0.014/+0.054	4.5	7.5	3	0.75
EPB3F-0304-05	3	+0.014/+0.054	4.5	7.5	5	0.75
EPB3F-0405-03	4	+0.020/+0.068	5.5	9.5	3	0.75
EPB3F-0405-04	4	+0.020/+0.068	5.5	9.5	4	0.75
EPB3F-0405-06	4	+0.020/+0.068	5.5	9.5	6	0.75
EPB3F-0506-035	5	+0.010/+0.040	6	10	3.5	0.5
EPB3F-0506-05	5	+0.010/+0.040	6	10	5	0.5
EPB3F-0506-06	5	+0.010/+0.040	6	10	6	0.5
EPB3F-0507-04	5	+0.020/+0.068	7	11	4	1
EPB3F-0507-05	5	+0.020/+0.068	7	11	5	1
EPB3F-0507-10	5	+0.020/+0.068	7	11	10	1
EPB3F-0607-045	6	+0.010/+0.040	7	11	4.5	0.5
EPB3F-0607-10	6	+0.010/+0.040	7	11	10	0.5
EPB3F-0608-04	6	+0.020/+0.068	8	12	4	1
EPB3F-0608-05	6	+0.020/+0.068	8	12	5	1
EPB3F-0608-06	6	+0.020/+0.068	8	12	6	1
EPB3F-0608-07	6	+0.020/+0.068	8	12	7	1
EPB3F-0608-08	6	+0.020/+0.068	8	12	8	1
EPB3F-0608-10	6	+0.020/+0.068	8	12	10	1
EPB3F-0708-08	7	+0.013/+0.049	8	12	8	0.5
EPB3F-0809-12	8	+0.013/+0.049	9	13	12	0.5
EPB3F-0810-03	8	+0.025/+0.083	10	15	3	1
EPB3F-0810-04	8	+0.025/+0.083	10	15	4	1
EPB3F-0810-055	8	+0.025/+0.083	10	15	5.5	1
EPB3F-0810-075	8	+0.025/+0.083	10	15	7.5	1
EPB3F-0810-095	8	+0.025/+0.083	10	15	9.5	1
EPB3F-0810-10	8	+0.025/+0.083	10	15	10	1
EPB3F-0810-15	8	+0.025/+0.083	10	15	15	1
EPB3F-0810-30	8	+0.025/+0.083	10	15	30	1
EPB3F-1012-04	10	+0.025/+0.083	12	18	4	1
EPB3F-1012-05	10	+0.025/+0.083	12	18	5	1
EPB3F-1012-06	10	+0.025/+0.083	12	18	6	1
EPB3F-1012-07	10	+0.025/+0.083	12	18	7	1
EPB3F-1012-09	10	+0.025/+0.083	12	18	9	1
EPB3F-1012-10	10	+0.025/+0.083	12	18	10	1
EPB3F-1012-12	10	+0.025/+0.083	12	18	12	1
EPB3F-1012-15	10	+0.025/+0.083	12	18	15	1
EPB3F-1012-17	10	+0.025/+0.083	12	18	17	1
EPB3F-101214-14	10	+0.025/+0.083	12	14	14	1
EPB3F-101216-06	10	+0.025/+0.083	12	16	6	1
EPB3F-101216-09	10	+0.025/+0.083	12	16	9	1
EPB3F-1213-12	12	+0.016/+0.059	13	17	12	0.5
EPB3F-1214-05	12	+0.032/+0.102	14	20	5	1
EPB3F-1214-06	12	+0.032/+0.102	14	20	6	1
EPB3F-1214-07	12	+0.032/+0.102	14	20	7	1
EPB3F-1214-09	12	+0.032/+0.102	14	20	9	1
EPB3F-1214-10	12	+0.032/+0.102	14	20	10	1
EPB3F-1214-11	12	+0.032/+0.102	14	20	11	1

产品编码 Part No.	d ₁ [mm]	d ₁ -公差 After fitting [mm]	d ₂ [mm]	d ₃ [d13] [mm]	L[h13] [mm]	T _{0.14} [mm]
EPB3F-1214-12	12	+0.032/+0.102	14	20	12	1
EPB3F-1214-15	12	+0.032/+0.102	14	20	15	1
EPB3F-1214-17	12	+0.032/+0.102	14	20	17	1
EPB3F-1214-20	12	+0.032/+0.102	14	20	20	1
EPB3F-1214-24	12	+0.032/+0.102	14	20	24	1
EPB3F-121415-10	12	+0.032/+0.102	14	15	10	1
EPB3F-1416-03	14	+0.032/+0.102	16	22	3	1
EPB3F-1416-04	14	+0.032/+0.102	16	22	4	1
EPB3F-1416-06	14	+0.032/+0.102	16	22	6	1
EPB3F-1416-08	14	+0.032/+0.102	16	22	8	1
EPB3F-1416-10	14	+0.032/+0.102	16	22	10	1
EPB3F-1416-12	14	+0.032/+0.102	16	22	12	1
EPB3F-1416-15	14	+0.032/+0.102	16	22	15	1
EPB3F-1416-17	14	+0.032/+0.102	16	22	17	1
EPB3F-1416-21	14	+0.032/+0.102	16	22	21	1
EPB3F-141617-15	14	+0.032/+0.102	16	17	15	1
EPB3F-1517-05	15	+0.032/+0.102	17	23	5	1
EPB3F-1517-09	15	+0.032/+0.102	17	23	9	1
EPB3F-1517-12	15	+0.032/+0.102	17	23	12	1
EPB3F-1517-17	15	+0.032/+0.102	17	23	17	1
EPB3F-1517-20	15	+0.032/+0.102	17	23	20	1
EPB3F-151718-12	15	+0.032/+0.102	17	18	12	1
EPB3F-1618-06	16	+0.032/+0.102	18	24	6	1
EPB3F-1618-09	16	+0.032/+0.102	18	24	9	1
EPB3F-1618-12	16	+0.032/+0.102	18	24	12	1
EPB3F-1618-17	16	+0.032/+0.102	18	24	17	1
EPB3F-1618-21	16	+0.032/+0.102	18	24	21	1
EPB3F-1719-09	17	+0.032/+0.102	19	25	9	1
EPB3F-1719-25	17	+0.032/+0.102	19	25	25	1
EPB3F-1820-04	18	+0.032/+0.102	20	26	4	1
EPB3F-1820-06	18	+0.032/+0.102	20	26	6	1
EPB3F-1820-09	18	+0.032/+0.102	20	26	9	1
EPB3F-1820-11	18	+0.032/+0.102	20	26	11	1
EPB3F-1820-12	18	+0.032/+0.102	20	26	12	1
EPB3F-1820-17	18	+0.032/+0.102	20	26	17	1
EPB3F-1820-22	18	+0.032/+0.102	20	26	22	1
EPB3F-1820-30	18	+0.032/+0.102	20	26	30	1
EPB3F-202223-21	20	+0.040/+0.124	22	23	21	1.5
EPB3F-2023-3.2	20	+0.040/+0.124	23	30	3.2	1.5
EPB3F-2023-07	20	+0.040/+0.124	23	30	7	1.5
EPB3F-2023-11.5	20	+0.040/+0.124	23	30	11.5	1.5
EPB3F-2023-16.5	20	+0.040/+0.124	23	30	16.5	1.5
EPB3F-2023-21.5	20	+0.040/+0.124	23	30	21.5	1.5
EPB3F-222535-09	22	+0.040/+0.124	25	35	9	1.5
EPB3F-2427-10	24	+0.040/+0.124	27	32	10	1.5
EPB3F-2528-11.5	25	+0.040/+0.124	28	35	11.5	1.5
EPB3F-2528-16.5	25	+0.040/+0.124	28	35	16.5	1.5
EPB3F-2528-21.5	25	+0.040/+0.124	28	35	21.5	1.5

EPB

CSB-EPB[®]

www.csb-ep.com
sales@csb-ep.com

Tel: 0086 573 84186133/84185527
Fax: 0086 573 84185517

产品编码 Part No.	d ₁ [mm]	d ₁ -公差 After fitting [mm]	d ₂ [mm]	d ₃ [d13] [mm]	L[h13] [mm]	T _{0.14} [mm]
EPB3F-2528-30	25	+0.040/+0.124	28	35	30	1.5
EPB3F-2830-36	28	+0.040/+0.124	30	35	36	2
EPB3F-3032-12	30	+0.040/+0.124	32	37	12	1
EPB3F-3034-16	30	+0.040/+0.124	34	42	16	2
EPB3F-3034-20	30	+0.040/+0.124	34	42	20	2
EPB3F-3034-26	30	+0.040/+0.124	34	42	26	2
EPB3F-3034-37	30	+0.040/+0.124	34	42	37	2
EPB3F-3034-45	30	+0.040/+0.124	34	42	45	2
EPB3F-3236-16	32	+0.050/+0.150	36	40	16	2
EPB3F-3236-26	32	+0.050/+0.150	36	40	26	2
EPB3F-3539-07	35	+0.050/+0.150	39	47	7	2
EPB3F-3539-12	35	+0.050/+0.150	39	47	12	2
EPB3F-3539-16	35	+0.050/+0.150	39	47	16	2
EPB3F-3539-26	35	+0.050/+0.150	39	47	26	2
EPB3F-3539-36	35	+0.050/+0.150	39	47	36	2
EPB3F-4044-14	40	+0.050/+0.150	44	52	14	2
EPB3F-4044-20	40	+0.050/+0.150	44	52	20	2
EPB3F-4044-30	40	+0.050/+0.150	44	52	30	2
EPB3F-4044-40	40	+0.050/+0.150	44	52	40	2
EPB3F-4044-50	40	+0.050/+0.150	44	52	50	2
EPB3F-4246-50	42	+0.050/+0.150	46	53	50	2

产品编码 Part No.	d ₁ [mm]	d ₁ -公差 After fitting [mm]	d ₂ [mm]	d ₃ [d13] [mm]	L[h13] [mm]	T _{0.14} [mm]
EPB3F-4550-15	45	+0.050/+0.150	50	58	15	2
EPB3F-4550-30	45	+0.050/+0.150	50	58	30	2
EPB3F-4550-50	45	+0.050/+0.150	50	58	50	2
EPB3F-5055-10	50	+0.050/+0.150	55	63	10	2
EPB3F-5055-40	50	+0.050/+0.150	55	63	40	2
EPB3F-5055-50	50	+0.050/+0.150	55	63	50	2
EPB3F-6065-07	60	+0.060/+0.180	65	73	7	2
EPB3F-6065-22	60	+0.060/+0.180	65	73	22	2
EPB3F-6065-30	60	+0.060/+0.180	65	73	30	2
EPB3F-6065-50	60	+0.060/+0.180	65	73	50	2
EPB3F-606580-62	60	+0.060/+0.180	65	80	62	2
EPB3F-6570-50	65	+0.060/+0.180	70	78	50	2
EPB3F-7075-50	70	+0.060/+0.180	75	83	50	2
EPB3F-9095-11	90	+0.072/+0.212	95	103	11	2.5
EPB3F-95100-22.5	95	+0.072/+0.212	100	108	22.5	2.5
EPB3F-100105-11.5	100	+0.072/+0.212	105	113	11.5	2.5
EPB3F-100105-100	100	+0.072/+0.212	105	113	100	2.5
EPB3F-120125-100	120	+0.072/+0.212	125	133	100	2.5

*d₁公差为压入标准H7座孔（符合ISO3547-1）后公差
*Tolerance d₁ after fitting into housing H7 (ISO3547-1)

垫片 Metric thrust washers

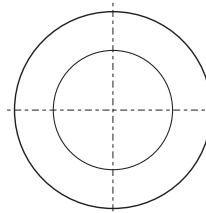
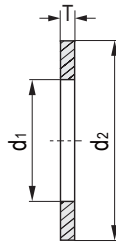

产品编码 Part No.:
EPB3W-0818-015
d₁ d₂ T
垫片 Washer
材料 Material

产品编码 Part No.	d ₁ ^{+0.25} [mm]	d ₂ ^{+0.25} [mm]	T _{0.05} [mm]
EPB3W-0509-006	5	9	0.6
EPB3W-0615-015	6	15	1.5
EPB3W-0620-015	6	20	1.5
EPB3W-0815-005	8	15	0.5
EPB3W-0815-015	8	15	1.5
EPB3W-0818-010	8	18	1.0
EPB3W-0818-015	8	18	1.5
EPB3W-1018-010	10	18	1.0
EPB3W-1018-015	10	18	1.5
EPB3W-1018-020	10	18	2.0
EPB3W-1224-015	12	24	1.5
EPB3W-1426-015	14	26	1.5
EPB3W-1524-015	15	24	1.5
EPB3W-1630-015	16	30	1.5

产品编码 Part No.	d ₁ ^{+0.25} [mm]	d ₂ ^{+0.25} [mm]	T _{0.05} [mm]
EPB3W-1832-015	18	32	1.5
EPB3W-2036-015	20	36	1.5
EPB3W-2238-015	22	38	1.5
EPB3W-2442-015	24	42	1.5
EPB3W-2640-0075	26	40	0.75
EPB3W-2644-015	26	44	1.5
EPB3W-2848-015	28	48	1.5
EPB3W-3254-015	32	54	1.5
EPB3W-3862-015	38	62	1.5
EPB3W-4266-015	42	66	1.5
EPB3W-4874-020	48	74	2.0
EPB3W-5278-020	52	78	2.0
EPB3W-6290-020	62	90	2.0

*根据要求提供定位孔设计 The fixing bore design upon request

CSB-EPB[®] Standard Specifications

EPB4/EPB8/EPB10/EPB24 标准规格

直套 Metric cylindrical bushings

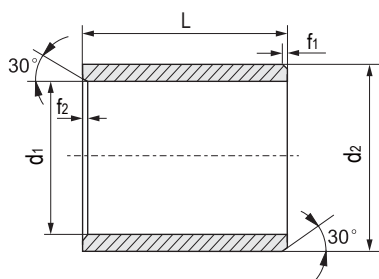

推荐安装公差 Recommend fitting tolerance:

座孔 Housing: H7

轴 Shaft: h9

产品编码 Part No.:

EPB4 -0203-03

d₁ d₂ L

材料 Material

d ₁	f ₁	f ₂
1-6	0.3	0.5
6-12	0.5	
12-30	0.8	
>30	1.2	

产品编码 Part No.	d ₁ [mm]	d ₁ -公差 After fitting [mm]	d ₂ [mm]	L(h13) [mm]
EPB4-0203-03	2	+0.006/+0.046	3.5	3
EPB4-0304-03	3	+0.006/+0.046	4.5	3
EPB4-0304-036	3	+0.006/+0.046	4.5	3.6
EPB4-0304-05	3	+0.006/+0.046	4.5	5
EPB4-0304-055	3	+0.006/+0.046	4.5	5.5
EPB4-0304-06	3	+0.006/+0.046	4.5	6
EPB4-0405-04	4	+0.010/+0.058	5.5	4
EPB4-0405-05	4	+0.010/+0.058	5.5	5
EPB4-0405-06	4	+0.010/+0.058	5.5	6
EPB4-0405-08	4	+0.010/+0.058	5.5	8
EPB4-0405-10	4	+0.010/+0.058	5.5	10
EPB4-0506-05	5	+0.010/+0.040	6	5
EPB4-0506-07	5	+0.010/+0.040	6	7
EPB4-0507-05	5	+0.010/+0.058	7	5
EPB4-0507-08	5	+0.010/+0.058	7	8
EPB4-0507-10	5	+0.010/+0.058	7	10
EPB4-0608-04	6	+0.010/+0.058	8	4
EPB4-0608-06	6	+0.010/+0.058	8	6
EPB4-0608-10	6	+0.010/+0.058	8	10
EPB4-0810-05	8	+0.013/+0.071	10	5
EPB4-0810-08	8	+0.013/+0.071	10	8
EPB4-0810-10	8	+0.013/+0.071	10	10
EPB4-0810-15	8	+0.013/+0.071	10	15
EPB4-1012-06	10	+0.013/+0.071	12	6
EPB4-1012-10	10	+0.013/+0.071	12	10
EPB4-1012-12	10	+0.013/+0.071	12	12
EPB4-1012-15	10	+0.013/+0.071	12	15
EPB4-1214-10	12	+0.016/+0.086	14	10
EPB4-1214-12	12	+0.016/+0.086	14	12
EPB4-1214-15	12	+0.016/+0.086	14	15

产品编码 Part No.	d ₁ [mm]	d ₁ -公差 After fitting [mm]	d ₂ [mm]	L(h13) [mm]
EPB4-1214-20	12	+0.016/+0.086	14	20
EPB4-1416-20	14	+0.016/+0.086	16	20
EPB4-1517-15	15	+0.016/+0.086	17	15
EPB4-1618-15	16	+0.016/+0.086	18	15
EPB4-1618-20	16	+0.016/+0.086	18	20
EPB4-1618-25	16	+0.016/+0.086	18	25
EPB4-1820-15	18	+0.016/+0.086	20	15
EPB4-1820-20	18	+0.016/+0.086	20	20
EPB4-1820-25	18	+0.016/+0.086	20	25
EPB4-2023-20	20	+0.020/+0.104	23	20
EPB4-2023-30	20	+0.020/+0.104	23	30
EPB4-2225-20	22	+0.020/+0.104	25	20
EPB4-2528-15	25	+0.020/+0.104	28	15
EPB4-2528-20	25	+0.020/+0.104	28	20
EPB4-3034-20	30	+0.020/+0.104	34	20
EPB4-3034-25	30	+0.020/+0.104	34	25
EPB4-3034-30	30	+0.020/+0.104	34	30
EPB4-3034-40	30	+0.020/+0.104	34	40
EPB4-3236-30	32	+0.025/+0.125	36	30
EPB4-3539-20	35	+0.025/+0.125	39	20
EPB4-3539-40	35	+0.025/+0.125	39	40
EPB4-4044-20	40	+0.025/+0.125	44	20
EPB4-4044-30	40	+0.025/+0.125	44	30
EPB4-4044-50	40	+0.025/+0.125	44	50
EPB4-4550-50	45	+0.025/+0.125	50	50
EPB4-5055-40	50	+0.025/+0.125	55	40
EPB4-5560-26	55	+0.030/+0.150	60	26
EPB4-6065-60	60	+0.030/+0.150	65	60

*d₁公差为压入标准H7座孔（符合ISO3547-1）后公差
*Tolerance d₁ after fitting into housing H7 (ISO3547-1)

EPB

CSB-EPB[®]

www.csb-ep.com
sales@csb-ep.com

Tel: 0086 573 84186133/84185527
Fax: 0086 573 84185517

法兰轴承 Metric flange bushings

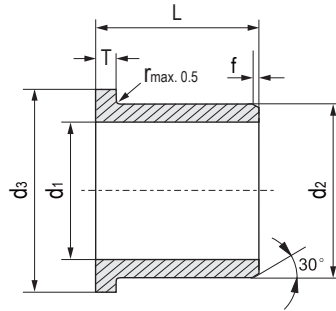

推荐安装公差 Recommend fitting tolerance:

座孔 Housing: H7

轴 Shaft: h9

产品编码 Part No.:

EPB4F-0304-03

$\begin{matrix} | & | & | & | \\ d_1 & d_2 & L & \\ \text{法兰轴承 Flange bushes} \end{matrix}$

材料 Material

d ₁	f
1-6	0.3
6-12	0.5
12-30	0.8
>30	1.2

产品编码 Part No.	d ₁ [mm]	d ₁ -公差 After fitting [D11] [mm]	d ₂ [mm]	d ₃ (d13) [mm]	L (h13) [mm]	T (h13) [mm]
EPB4F-0304-03	3	+0.006/+0.046	4.5	7.5	3	0.75
EPB4F-0304-05	3	+0.006/+0.046	4.5	7.5	5	0.75
EPB4F-0405-03	4	+0.010/+0.058	5.5	9.5	3	0.75
EPB4F-0405-04	4	+0.010/+0.058	5.5	9.5	4	0.75
EPB4F-0405-06	4	+0.010/+0.058	5.5	9.5	6	0.75
EPB4F-0507-04	5	+0.010/+0.058	7	11	4	1
EPB4F-0507-05	5	+0.010/+0.058	7	11	5	1
EPB4F-0507-10	5	+0.010/+0.058	7	11	10	1
EPB4F-0608-04	6	+0.010/+0.058	8	12	4	1
EPB4F-0608-06	6	+0.010/+0.058	8	12	6	1
EPB4F-0608-10	6	+0.010/+0.058	8	12	10	1
EPB4F-0810-055	8	+0.013/+0.071	10	15	5.5	1
EPB4F-0810-075	8	+0.013/+0.071	10	15	7.5	1
EPB4F-0810-095	8	+0.013/+0.071	10	15	9.5	1
EPB4F-0810-10	8	+0.013/+0.071	10	15	10	1
EPB4F-0810-15	8	+0.013/+0.071	10	15	15	1
EPB4F-1012-04	10	+0.013/+0.071	12	18	4	1
EPB4F-1012-05	10	+0.013/+0.071	12	18	5	1
EPB4F-1012-09	10	+0.013/+0.071	12	18	9	1
EPB4F-1012-10	10	+0.013/+0.071	12	18	10	1
EPB4F-1012-12	10	+0.013/+0.071	12	18	12	1
EPB4F-1012-15	10	+0.013/+0.071	12	18	15	1
EPB4F-1012-17	10	+0.013/+0.071	12	18	17	1
EPB4F-1214-07	12	+0.016/+0.086	14	20	7	1
EPB4F-1214-10	12	+0.016/+0.086	14	20	10	1

产品编码 Part No.	d ₁ [mm]	d ₁ -公差 After fitting [D11] [mm]	d ₂ [mm]	d ₃ (d13) [mm]	L (h13) [mm]	T (h13) [mm]
EPB4F-1214-12	12	+0.016/+0.086	14	20	12	1
EPB4F-1214-15	12	+0.016/+0.086	14	20	15	1
EPB4F-1214-20	12	+0.016/+0.086	14	20	20	1
EPB4F-1416-12	14	+0.016/+0.086	16	22	12	1
EPB4F-1517-17	15	+0.016/+0.086	17	23	17	1
EPB4F-1618-17	16	+0.016/+0.086	18	24	17	1
EPB4F-1820-12	18	+0.016/+0.086	20	26	12	1
EPB4F-1820-17	18	+0.016/+0.086	20	26	17	1
EPB4F-2023-07	20	+0.020/+0.104	23	30	7	1.5
EPB4F-2023-11.5	20	+0.020/+0.104	23	30	11.5	1.5
EPB4F-2023-16.5	20	+0.020/+0.104	23	30	16.5	1.5
EPB4F-2023-21.5	20	+0.020/+0.104	23	30	21.5	1.5
EPB4F-2023-30	20	+0.020/+0.104	23	30	30	1.5
EPB4F-2528-30	25	+0.020/+0.104	28	35	30	1.5
EPB4F-3034-40	30	+0.020/+0.104	34	42	40	2
EPB4F-3539-26	35	+0.025/+0.125	39	47	26	2
EPB4F-4044-40	40	+0.025/+0.125	44	52	40	2
EPB4F-4550-50	45	+0.025/+0.125	50	58	50	2
EPB4F-5055-50	50	+0.025/+0.125	55	63	50	2
EPB4F-6065-50	60	+0.030/+0.150	65	75	50	2
EPB4F-7075-50	70	+0.030/+0.150	75	83	50	2

*d₁公差为压入标准H7座孔 (符合ISO3547-1) 后公差
*Tolerance d₁ after fitting into housing H7 (ISO3547-1)

CSB-EPB[®] Standard Specifications

EPB4/EPB8/EPB10/EPB24 标准规格

垫片 Metric thrust washers

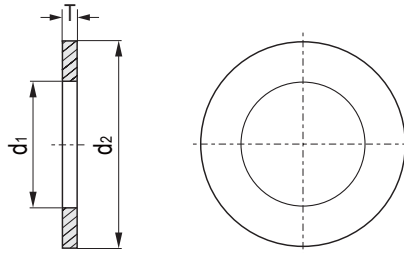

产品编码 Part No.:

EPB4W-0818-015

d₁ d₂ T
垫片 Washer

材料 Material

产品编码 Part No.	d ₁ ^{+0.25} [mm]	d ₂ ^{-0.25} [mm]	T _{-0.05} [mm]
EPB4W-0509-006	5	9	0.6
EPB4W-0615-015	6	15	1.5
EPB4W-0620-015	6	20	1.5
EPB4W-0815-005	8	15	0.5
EPB4W-0815-015	8	15	1.5
EPB4W-0818-010	8	18	1.0
EPB4W-0818-015	8	18	1.5
EPB4W-1018-010	10	18	1.0
EPB4W-1018-015	10	18	1.5
EPB4W-1018-020	10	18	2.0
EPB4W-1224-015	12	24	1.5
EPB4W-1426-015	14	26	1.5
EPB4W-1524-015	15	24	1.5
EPB4W-1630-015	16	30	1.5
EPB4W-1832-015	18	32	1.5

产品编码 Part No.	d ₁ ^{+0.25} [mm]	d ₂ ^{-0.25} [mm]	T _{-0.05} [mm]
EPB4W-2036-015	20	36	1.5
EPB4W-2238-015	22	38	1.5
EPB4W-2442-015	24	42	1.5
EPB4W-2640-0075	26	40	0.75
EPB4W-2644-015	26	44	1.5
EPB4W-2848-015	28	48	1.5
EPB4W-3254-015	32	54	1.5
EPB4W-3862-015	38	62	1.5
EPB4W-4266-015	42	66	1.5
EPB4W-4874-020	48	74	2.0
EPB4W-5278-020	52	78	2.0
EPB4W-6290-020	62	90	2.0

*根据要求提供定位孔设计 The fixing bore design upon request

EPB

CSB-EPB[®]

www.csb-ep.com
sales@csb-ep.com

Tel: 0086 573 84186133/84185527
Fax: 0086 573 84185517

直套 Metric cylindrical bushings

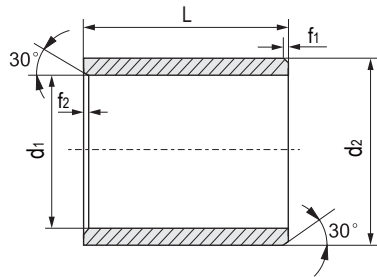

推荐安装公差 Recommend fitting tolerance:

座孔 Housing: H7

轴 Shaft: h9

产品编码 Part No.:

EPB5 -0608-06

材料 Material
 EPB5 -0608-06
 d₁ d₂ L

d ₁	f ₁	f ₂
1-6	0.3	0.5
6-12	0.5	
12-30	0.8	
>30	1.2	

产品编码 Part No.	d ₁ [mm]	d ₁ -公差 After fitting [mm]	d ₂ [mm]	L(h13) [mm]
EPB5-0203-03	2	+0.006/+0.046	3.5	3
EPB5-0304-03	3	+0.006/+0.046	4.5	3
EPB5-0304-05	3	+0.006/+0.046	4.5	5
EPB5-0304-06	3	+0.006/+0.046	4.5	6
EPB5-0405-04	4	+0.010/+0.058	5.5	4
EPB5-0405-05	4	+0.010/+0.058	5.5	5
EPB5-0405-06	4	+0.010/+0.058	5.5	6
EPB5-0405-08	4	+0.010/+0.058	5.5	8
EPB5-0405-10	4	+0.010/+0.058	5.5	10
EPB5-0507-05	5	+0.010/+0.058	7	5
EPB5-0507-08	5	+0.010/+0.058	7	8
EPB5-0507-10	5	+0.010/+0.058	7	10
EPB5-0608-04	6	+0.010/+0.058	8	4
EPB5-0608-06	6	+0.010/+0.058	8	6
EPB5-0608-08	6	+0.010/+0.058	8	8
EPB5-0608-09	6	+0.010/+0.058	8	9
EPB5-0608-10	6	+0.010/+0.058	8	10
EPB5-0608-15	6	+0.010/+0.058	8	15
EPB5-0810-05	8	+0.013/+0.071	10	5
EPB5-0810-06	8	+0.013/+0.071	10	6
EPB5-0810-08	8	+0.013/+0.071	10	8
EPB5-0810-10	8	+0.013/+0.071	10	10
EPB5-0810-12	8	+0.013/+0.071	10	12
EPB5-0810-13	8	+0.013/+0.071	10	13
EPB5-0810-15	8	+0.013/+0.071	10	15
EPB5-0810-21	8	+0.013/+0.071	10	21
EPB5-1012-04	10	+0.013/+0.071	12	4
EPB5-1012-06	10	+0.013/+0.071	12	6
EPB5-1012-08	10	+0.013/+0.071	12	8
EPB5-1012-10	10	+0.013/+0.071	12	10
EPB5-1012-12	10	+0.013/+0.071	12	12
EPB5-1012-15	10	+0.013/+0.071	12	15
EPB5-1012-20	10	+0.013/+0.071	12	20
EPB5-1214-05	12	+0.016/+0.086	14	5
EPB5-1214-06	12	+0.016/+0.086	14	6
EPB5-1214-08	12	+0.016/+0.086	14	8
EPB5-1214-10	12	+0.016/+0.086	14	10
EPB5-1214-12	12	+0.016/+0.086	14	12
EPB5-1214-15	12	+0.016/+0.086	14	15
EPB5-1214-20	12	+0.016/+0.086	14	20

产品编码 Part No.	d ₁ [mm]	d ₁ -公差 After fitting [mm]	d ₂ [mm]	L(h13) [mm]
EPB5-1214-25	12	+0.016/+0.086	14	25
EPB5-1315-15	13	+0.016/+0.086	15	15
EPB5-1315-20	13	+0.016/+0.086	15	20
EPB5-1416-08	14	+0.016/+0.086	16	8
EPB5-1416-10	14	+0.016/+0.086	16	10
EPB5-1416-12	14	+0.016/+0.086	16	12
EPB5-1416-15	14	+0.016/+0.086	16	15
EPB5-1416-20	14	+0.016/+0.086	16	20
EPB5-1416-25	14	+0.016/+0.086	16	25
EPB5-1517-10	15	+0.016/+0.086	17	10
EPB5-1517-15	15	+0.016/+0.086	17	15
EPB5-1517-20	15	+0.016/+0.086	17	20
EPB5-1517-25	15	+0.016/+0.086	17	25
EPB5-1618-08	16	+0.016/+0.086	18	8
EPB5-1618-10	16	+0.016/+0.086	18	10
EPB5-1618-12	16	+0.016/+0.086	18	12
EPB5-1618-15	16	+0.016/+0.086	18	15
EPB5-1618-20	16	+0.016/+0.086	18	20
EPB5-1618-25	16	+0.016/+0.086	18	25
EPB5-1719-20	17	+0.016/+0.086	19	20
EPB5-1820-15	18	+0.016/+0.086	20	15
EPB5-1820-20	18	+0.016/+0.086	20	20
EPB5-2022-15	20	+0.020/+0.104	22	15
EPB5-2023-10	20	+0.020/+0.104	23	10
EPB5-2023-15	20	+0.020/+0.104	23	15
EPB5-2023-20	20	+0.020/+0.104	23	20
EPB5-2023-23	20	+0.020/+0.104	23	23
EPB5-2023-25	20	+0.020/+0.104	23	25
EPB5-2023-30	20	+0.020/+0.104	23	30
EPB5-2225-15	22	+0.020/+0.104	25	15
EPB5-2225-20	22	+0.020/+0.104	25	20
EPB5-2225-25	22	+0.020/+0.104	25	25
EPB5-2225-30	22	+0.020/+0.104	25	30
EPB5-2528-12	25	+0.020/+0.104	28	12
EPB5-2528-15	25	+0.020/+0.104	28	15
EPB5-2528-20	25	+0.020/+0.104	28	20
EPB5-2528-25	25	+0.020/+0.104	28	25
EPB5-2528-30	25	+0.020/+0.104	28	30
EPB5-2832-20	28	+0.020/+0.104	32	20
EPB5-2832-25	28	+0.020/+0.104	32	25

CSB-EPB[®] Standard Specifications

EPB5/EPB5A/EPB5Z 标准规格

产品编码 Part No.	d ₁ [mm]	d ₁ -公差 After fitting [mm]	d ₂ [mm]	L(h13) [mm]
EPB5-2832-30	28	+0.020/+0.104	32	30
EPB5-3034-20	30	+0.020/+0.104	34	20
EPB5-3034-25	30	+0.020/+0.104	34	25
EPB5-3034-30	30	+0.020/+0.104	34	30
EPB5-3034-40	30	+0.020/+0.104	34	40
EPB5-3236-20	32	+0.025/+0.125	36	20
EPB5-3236-30	32	+0.025/+0.125	36	30
EPB5-3236-40	32	+0.025/+0.125	36	40
EPB5-3539-20	35	+0.025/+0.125	39	20
EPB5-3539-25	35	+0.025/+0.125	39	25
EPB5-3539-30	35	+0.025/+0.125	39	30
EPB5-3539-40	35	+0.025/+0.125	39	40
EPB5-3539-50	35	+0.025/+0.125	39	50
EPB5-4044-15	40	+0.025/+0.125	44	15

产品编码 Part No.	d ₁ [mm]	d ₁ -公差 After fitting [mm]	d ₂ [mm]	L(h13) [mm]
EPB5-4044-20	40	+0.025/+0.125	44	20
EPB5-4044-30	40	+0.025/+0.125	44	30
EPB5-4044-40	40	+0.025/+0.125	44	40
EPB5-4044-50	40	+0.025/+0.125	44	50
EPB5-4550-30	45	+0.025/+0.125	50	30
EPB5-5055-40	50	+0.025/+0.125	55	40
EPB5-5055-50	50	+0.025/+0.125	55	50
EPB5-5560-20	55	+0.030/+0.150	60	20
EPB5-5560-40	55	+0.030/+0.150	60	40
EPB5-6065-45	60	+0.030/+0.150	65	45
EPB5-6065-50	60	+0.030/+0.150	65	50

*d₁公差为压入标准H7座孔（符合ISO3547-1）后公差
*Tolerance d₁ after fitting into housing H7 (ISO3547-1)

法兰轴承 Metric Flange Bushings

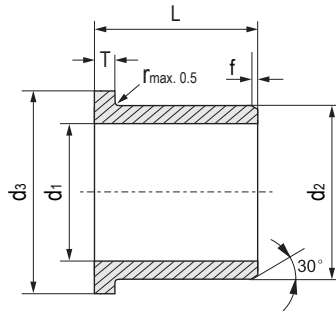

推荐安装公差 Recommend fitting tolerance:

座孔 Housing: H7

轴 Shaft: h9

产品编码 Part No.:

EPB5F-0608-06

法兰轴承 Flange bushes

材料 Material

d ₁	f
1-6	0.3
6-12	0.5
12-30	0.8
>30	1.2

产品编码 Part No.	d ₁ [mm]	d ₁ -公差 After fitting [mm]	d ₂ [mm]	d ₃ (d13) [mm]	L(h13) [mm]	T _{0.14} [mm]
EPB5F-0304-03	3	+0.006/+0.046	4.5	7.5	3	0.75
EPB5F-0304-05	3	+0.006/+0.046	4.5	7.5	5	0.75
EPB5F-0405-03	4	+0.010/+0.058	5.5	9.5	3	0.75
EPB5F-0405-04	4	+0.010/+0.058	5.5	9.5	4	0.75
EPB5F-0405-06	4	+0.010/+0.058	5.5	9.5	6	0.75
EPB5F-0507-04	5	+0.010/+0.058	7	11	4	1
EPB5F-0507-05	5	+0.010/+0.058	7	11	5	1
EPB5F-0507-10	5	+0.010/+0.058	7	11	10	1
EPB5F-0608-04	6	+0.010/+0.058	8	12	4	1
EPB5F-0608-06	6	+0.010/+0.058	8	12	6	1
EPB5F-0608-07	6	+0.010/+0.058	8	12	7	1
EPB5F-0608-08	6	+0.010/+0.058	8	12	8	1
EPB5F-0608-10	6	+0.010/+0.058	8	12	10	1
EPB5F-0810-04	8	+0.013/+0.071	10	15	4	1
EPB5F-0810-055	8	+0.013/+0.071	10	15	5.5	1
EPB5F-0810-075	8	+0.013/+0.071	10	15	7.5	1
EPB5F-0810-095	8	+0.013/+0.071	10	15	9.5	1
EPB5F-0810-10	8	+0.013/+0.071	10	15	10	1
EPB5F-0810-15	8	+0.013/+0.071	10	15	15	1
EPB5F-1012-05	10	+0.013/+0.071	12	18	5	1
EPB5F-1012-06	10	+0.013/+0.071	12	18	6	1

产品编码 Part No.	d ₁ [mm]	d ₁ -公差 After fitting [mm]	d ₂ [mm]	d ₃ (d13) [mm]	L(h13) [mm]	T _{0.14} [mm]
EPB5F-1012-07	10	+0.013/+0.071	12	18	7	1
EPB5F-1012-08	10	+0.013/+0.071	12	18	8	1
EPB5F-1012-09	10	+0.013/+0.071	12	18	9	1
EPB5F-1012-10	10	+0.013/+0.071	12	18	10	1
EPB5F-1012-12	10	+0.013/+0.071	12	18	12	1
EPB5F-1012-15	10	+0.013/+0.071	12	18	15	1
EPB5F-1012-17	10	+0.013/+0.071	12	18	17	1
EPB5F-1214-05	12	+0.016/+0.086	14	20	5	1
EPB5F-1214-06	12	+0.016/+0.086	14	20	6	1
EPB5F-1214-07	12	+0.016/+0.086	14	20	7	1
EPB5F-1214-09	12	+0.016/+0.086	14	20	9	1
EPB5F-1214-10	12	+0.016/+0.086	14	20	10	1
EPB5F-1214-12	12	+0.016/+0.086	14	20	12	1
EPB5F-1214-15	12	+0.016/+0.086	14	20	15	1
EPB5F-1214-17	12	+0.016/+0.086	14	20	17	1
EPB5F-1214-20	12	+0.016/+0.086	14	20	20	1
EPB5F-1416-10	14	+0.016/+0.086	16	22	10	1
EPB5F-1416-12	14	+0.016/+0.086	16	22	12	1
EPB5F-1416-17	14	+0.016/+0.086	16	22	17	1
EPB5F-1517-04	15	+0.016/+0.086	17	23	4	1
EPB5F-1517-05	15	+0.016/+0.086	17	23	5	1

EPB

CSB-EPB[®]

www.csb-ep.com
sales@csb-ep.com

Tel: 0086 573 84186133/84185527
Fax: 0086 573 84185517

产品编码 Part No.	d ₁ [mm]	d ₁ -公差 After fitting [mm]	d ₂ [mm]	d ₃ (d13) [mm]	L(h13) [mm]	T _{-0.14} [mm]
EPB5F-1517-09	15	+0.016/+0.086	17	23	9	1
EPB5F-1517-12	15	+0.016/+0.086	17	23	12	1
EPB5F-1517-17	15	+0.016/+0.086	17	23	17	1
EPB5F-1517-20	15	+0.016/+0.086	17	23	20	1
EPB5F-1618-04	16	+0.016/+0.086	18	24	4	1
EPB5F-1618-06	16	+0.016/+0.086	18	24	6	1
EPB5F-1618-09	16	+0.016/+0.086	18	24	9	1
EPB5F-1618-12	16	+0.016/+0.086	18	24	12	1
EPB5F-1618-17	16	+0.016/+0.086	18	24	17	1
EPB5F-1618-20	16	+0.016/+0.086	18	24	20	1
EPB5F-1618-25	16	+0.016/+0.086	18	24	25	1
EPB5F-1820-09	18	+0.016/+0.086	20	26	9	1
EPB5F-1820-12	18	+0.016/+0.086	20	26	12	1
EPB5F-1820-17	18	+0.016/+0.086	20	26	17	1
EPB5F-1820-20	18	+0.016/+0.086	20	26	20	1
EPB5F-1820-22	18	+0.016/+0.086	20	26	22	1
EPB5F-1820-32	18	+0.016/+0.086	20	26	32	1
EPB5F-2022-20	20	+0.020/+0.104	22	29	20	1.5
EPB5F-2023-07	20	+0.020/+0.104	23	30	7	1.5
EPB5F-2023-11.5	20	+0.020/+0.104	23	30	11.5	1.5
EPB5F-2023-16.5	20	+0.020/+0.104	23	30	16.5	1.5
EPB5F-2023-21.5	20	+0.020/+0.104	23	30	21.5	1.5
EPB5F-2224-16	22	+0.020/+0.104	24	30	16	1
EPB5F-2224-20	22	+0.020/+0.104	24	30	20	1

产品编码 Part No.	d ₁ [mm]	d ₁ -公差 After fitting [mm]	d ₂ [mm]	d ₃ (d13) [mm]	L(h13) [mm]	T _{-0.14} [mm]
EPB5F-2528-11.5	25	+0.020/+0.104	28	35	11.5	1.5
EPB5F-2528-16.5	25	+0.020/+0.104	28	35	16.5	1.5
EPB5F-2528-21.5	25	+0.020/+0.104	28	35	21.5	1.5
EPB5F-3034-16	30	+0.020/+0.104	34	42	16	2
EPB5F-3034-26	30	+0.020/+0.104	34	42	26	2
EPB5F-3034-37	30	+0.020/+0.104	34	42	37	2
EPB5F-3236-16	32	+0.025/+0.125	36	45	16	2
EPB5F-3236-26	32	+0.025/+0.125	36	45	26	2
EPB5F-3539-09	35	+0.025/+0.125	39	47	9	2
EPB5F-3539-16	35	+0.025/+0.125	39	47	16	2
EPB5F-3539-26	35	+0.025/+0.125	39	47	26	2
EPB5F-3539-40	35	+0.025/+0.125	39	47	40	2
EPB5F-4044-14	40	+0.025/+0.125	44	52	14	2
EPB5F-4044-30	40	+0.025/+0.125	44	52	30	2
EPB5F-4044-40	40	+0.025/+0.125	44	52	40	2
EPB5F-4044-50	40	+0.025/+0.125	44	52	50	2
EPB5F-4550-50	45	+0.025/+0.125	50	58	50	2
EPB5F-5055-40	50	+0.025/+0.125	55	63	40	2
EPB5F-5055-50	50	+0.025/+0.125	55	63	50	2
EPB5F-6065-30	60	+0.030/+0.150	65	75	30	2
EPB5F-6065-60	60	+0.030/+0.150	65	75	60	2

*d₁公差为压入标准H7座孔（符合ISO3547-1）后公差
*Tolerance d₁ after fitting into housing H7 (ISO3547-1)

垫片 Metric Thrust Washers

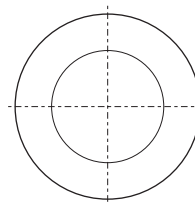
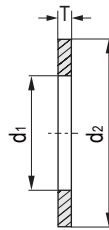

产品编码 Part No.:
EPB5W-0509-006
 d₁ d₂ T
 垫片 Washer
 材料 Material

产品编码 Part No.	d ₁ ^{+0.25} [mm]	d ₂ ^{-0.25} [mm]	T _{-0.05} [mm]
EPB5W-0509-006	5	9	0.6
EPB5W-0615-015	6	15	1.5
EPB5W-0620-015	6	20	1.5
EPB5W-0815-005	8	15	0.5
EPB5W-0815-015	8	15	1.5
EPB5W-0818-010	8	18	1.0
EPB5W-0818-015	8	18	1.5
EPB5W-1018-010	10	18	1.0
EPB5W-1018-015	10	18	1.5
EPB5W-1018-020	10	18	2.0
EPB5W-1224-015	12	24	1.5
EPB5W-1426-015	14	26	1.5
EPB5W-1524-015	15	24	1.5
EPB5W-1630-015	16	30	1.5

产品编码 Part No.	d ₁ ^{+0.25} [mm]	d ₂ ^{-0.25} [mm]	T _{-0.05} [mm]
EPB5W-1832-015	18	32	1.5
EPB5W-2036-015	20	36	1.5
EPB5W-2238-015	22	38	1.5
EPB5W-2442-015	24	42	1.5
EPB5W-2640-0075	26	40	0.75
EPB5W-2644-015	26	44	1.5
EPB5W-2848-015	28	48	1.5
EPB5W-3254-015	32	54	1.5
EPB5W-3862-015	38	62	1.5
EPB5W-4266-015	42	66	1.5
EPB5W-4874-020	48	74	2.0
EPB5W-5278-020	52	78	2.0
EPB5W-6290-020	62	90	2.0

*根据要求提供定位孔设计 The fixing bore design upon request

CSB-EPB[®] Standard Specifications

EPB7\EPB3M\EPB15\EPB19\EPB23\EPB25 标准规格

直套 Metric cylindrical bushings

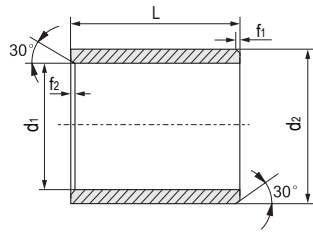

推荐安装公差 Recommend fitting tolerance:

座孔 Housing: H7

轴 Shaft: h9

产品编码 Part No.:

EPB7-0608-06

材料 Material

d ₁	f ₁	f ₂
1-6	0.3	0.5
6-12	0.5	
12-30	0.8	
>30	1.2	

产品编码 Part No.	d ₁ [mm]	d ₁ -公差 After fitting [mm]	d ₂ [mm]	L[h13] [mm]
EPB7-0203-03	2	+0.014/+0.054	3.5	3
EPB7-0304-03	3	+0.014/+0.054	4.5	3
EPB7-0304-036	3	+0.014/+0.054	4.5	3.6
EPB7-0304-05	3	+0.014/+0.054	4.5	5
EPB7-0304-055	3	+0.014/+0.054	4.5	5.5
EPB7-0304-06	3	+0.014/+0.054	4.5	6
EPB7-0405-04	4	+0.020/+0.068	5.5	4
EPB7-0405-05	4	+0.020/+0.068	5.5	5
EPB7-0405-06	4	+0.020/+0.068	5.5	6
EPB7-0405-08	4	+0.020/+0.068	5.5	8
EPB7-0405-10	4	+0.020/+0.068	5.5	10
EPB7-0506-05	5	+0.010/+0.040	6	5
EPB7-0506-07	5	+0.010/+0.040	6	7
EPB7-0507-05	5	+0.020/+0.068	7	5
EPB7-0507-08	5	+0.020/+0.068	7	8
EPB7-0507-10	5	+0.020/+0.068	7	10
EPB7-0509-05	5	+0.030/+0.105	9	5
EPB7-0509-08	5	+0.030/+0.105	9	8
EPB7-0608-04	6	+0.020/+0.068	8	4
EPB7-0608-06	6	+0.020/+0.068	8	6
EPB7-0608-08	6	+0.020/+0.068	8	8
EPB7-0608-09	6	+0.020/+0.068	8	9
EPB7-0608-10	6	+0.020/+0.068	8	10
EPB7-0608-15	6	+0.020/+0.068	8	15
EPB7-0610-04	6	+0.030/+0.105	10	4
EPB7-0610-06	6	+0.030/+0.105	10	6
EPB7-0610-08	6	+0.030/+0.105	10	8
EPB7-0610-10	6	+0.030/+0.105	10	10
EPB7-0612-06	6	+0.030/+0.105	12	6
EPB7-0612-10	6	+0.030/+0.105	12	10
EPB7-0810-05	8	+0.025/+0.083	10	5
EPB7-0810-06	8	+0.025/+0.083	10	6
EPB7-0810-08	8	+0.025/+0.083	10	8
EPB7-0810-10	8	+0.025/+0.083	10	10
EPB7-0810-12	8	+0.025/+0.083	10	12
EPB7-0810-15	8	+0.025/+0.083	10	15
EPB7-0810-21	8	+0.025/+0.083	10	21
EPB7-0812-06	8	+0.040/+0.130	12	6
EPB7-0812-08	8	+0.040/+0.130	12	8
EPB7-0814-06	8	+0.040/+0.130	14	6
EPB7-1012-04	10	+0.025/+0.083	12	4
EPB7-1012-06	10	+0.025/+0.083	12	6
EPB7-1012-08	10	+0.025/+0.083	12	8
EPB7-1012-10	10	+0.025/+0.083	12	10
EPB7-1012-12	10	+0.025/+0.083	12	12
EPB7-1012-15	10	+0.025/+0.083	12	15
EPB7-1012-20	10	+0.025/+0.083	12	20
EPB7-1014-10	10	+0.040/+0.130	14	10

产品编码 Part No.	d ₁ [mm]	d ₁ -公差 After fitting [mm]	d ₂ [mm]	L[h13] [mm]
EPB7-1214-05	12	+0.032/+0.102	14	5
EPB7-1214-06	12	+0.032/+0.102	14	6
EPB7-1214-08	12	+0.032/+0.102	14	8
EPB7-1214-10	12	+0.032/+0.102	14	10
EPB7-1214-12	12	+0.032/+0.102	14	12
EPB7-1214-15	12	+0.032/+0.102	14	15
EPB7-1214-20	12	+0.032/+0.102	14	20
EPB7-1214-25	12	+0.032/+0.102	14	25
EPB7-1216-10	12	+0.050/+0.160	16	10
EPB7-1216-20	12	+0.050/+0.160	16	20
EPB7-1315-15	13	+0.032/+0.102	15	15
EPB7-1315-20	13	+0.032/+0.102	15	20
EPB7-1416-08	14	+0.032/+0.102	16	8
EPB7-1416-10	14	+0.032/+0.102	16	10
EPB7-1416-12	14	+0.032/+0.102	16	12
EPB7-1416-15	14	+0.032/+0.102	16	15
EPB7-1416-20	14	+0.032/+0.102	16	20
EPB7-1416-25	14	+0.032/+0.102	16	25
EPB7-1517-10	15	+0.032/+0.102	17	10
EPB7-1517-15	15	+0.032/+0.102	17	15
EPB7-1517-20	15	+0.032/+0.102	17	20
EPB7-1517-25	15	+0.032/+0.102	17	25
EPB7-1618-08	16	+0.032/+0.102	18	8
EPB7-1618-10	16	+0.016/+0.086	18	10
EPB7-1618-12	16	+0.032/+0.102	18	12
EPB7-1618-15	16	+0.032/+0.102	18	15
EPB7-1618-20	16	+0.032/+0.102	18	20
EPB7-1618-25	16	+0.032/+0.102	18	25
EPB7-1820-15	18	+0.032/+0.102	20	15
EPB7-1820-20	18	+0.032/+0.102	20	20
EPB7-2022-15	20	+0.040/+0.124	22	15
EPB7-2023-10	20	+0.040/+0.124	23	10
EPB7-2023-15	20	+0.040/+0.124	23	15
EPB7-2023-20	20	+0.040/+0.124	23	20
EPB7-2023-23	20	+0.040/+0.124	23	23
EPB7-2023-25	20	+0.040/+0.124	23	25
EPB7-2023-30	20	+0.040/+0.124	23	30
EPB7-2224-20	22	+0.040/+0.124	24	20
EPB7-2224-35	22	+0.040/+0.124	24	35
EPB7-2225-15	22	+0.040/+0.124	25	15
EPB7-2225-20	22	+0.040/+0.124	25	20
EPB7-2225-25	22	+0.040/+0.124	25	25
EPB7-2225-30	22	+0.040/+0.124	25	30
EPB7-2427-20	24	+0.040/+0.124	27	20
EPB7-2427-25	24	+0.040/+0.124	27	25
EPB7-2528-12	25	+0.040/+0.124	28	12
EPB7-2528-15	25	+0.040/+0.124	28	15
EPB7-2528-20	25	+0.040/+0.124	28	20

EPB

CSB-EPB[®]

www.csb-ep.com
sales@csb-ep.com

Tel: 0086 573 84186133/84185527
Fax: 0086 573 84185517

产品编码 Part No.	d ₁ [mm]	d ₁ -公差 After fitting [mm]	d ₂ [mm]	L[h13] [mm]
EPB7-2528-25	25	+0.040/+0.124	28	25
EPB7-2528-30	25	+0.040/+0.124	28	30
EPB7-2532-30	25	+0.065/+0.195	32	30
EPB7-2832-20	28	+0.040/+0.124	32	20
EPB7-2832-25	28	+0.040/+0.124	32	25
EPB7-2832-30	28	+0.040/+0.124	32	30
EPB7-3034-20	30	+0.040/+0.124	34	20
EPB7-3034-25	30	+0.040/+0.124	34	25
EPB7-3034-30	30	+0.040/+0.124	34	30
EPB7-3034-40	30	+0.040/+0.124	34	40
EPB7-3038-20	30	+0.065/+0.195	38	20
EPB7-3236-20	32	+0.050/+0.150	36	20
EPB7-3236-30	32	+0.050/+0.150	36	30
EPB7-3236-40	32	+0.050/+0.150	36	40
EPB7-3539-20	35	+0.050/+0.150	39	20
EPB7-3539-25	35	+0.050/+0.150	39	25
EPB7-3539-30	35	+0.050/+0.150	39	30

产品编码 Part No.	d ₁ [mm]	d ₁ -公差 After fitting [mm]	d ₂ [mm]	L[h13] [mm]
EPB7-3539-40	35	+0.050/+0.150	39	40
EPB7-3539-50	35	+0.050/+0.150	39	50
EPB7-4044-15	40	+0.050/+0.150	44	15
EPB7-4044-20	40	+0.050/+0.150	44	20
EPB7-4044-30	40	+0.050/+0.150	44	30
EPB7-4044-40	40	+0.050/+0.150	44	40
EPB7-4044-50	40	+0.050/+0.150	44	50
EPB7-4550-30	45	+0.050/+0.150	50	30
EPB7-5055-40	50	+0.050/+0.150	55	40
EPB7-5055-50	50	+0.050/+0.150	55	50
EPB7-5560-20	55	+0.030/+0.150	60	20
EPB7-5560-40	55	+0.030/+0.150	60	40
EPB7-6065-45	60	+0.030/+0.150	65	45
EPB7-6065-50	60	+0.030/+0.150	65	50

*d₁公差为压入标准H7座孔（符合ISO3547-1）后公差
*Tolerance d₁ after fitting into housing H7 (ISO3547-1)

法兰轴承 Metric flange bushings

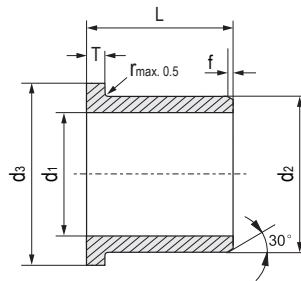

推荐安装公差 Recommend fitting tolerance:

座孔 Housing: H7

轴 Shaft: h9

产品编码 Part No.:

EPB7F-0608-06

材料 Material
法兰轴承 Flange bushes

d ₁	f
1-6	0.3
6-12	0.5
12-30	0.8
>30	1.2

产品编码 Part No.	d ₁ [mm]	d ₁ -公差 After fitting [mm]	d ₂ [mm]	d ₃ [d13] [mm]	L[h13] [mm]	T _{0.14} [mm]
EPB7F-0304-03	3	+0.014/+0.054	4.5	7.5	3	0.75
EPB7F-0304-05	3	+0.014/+0.054	4.5	7.5	5	0.75
EPB7F-0405-03	4	+0.020/+0.068	5.5	9.5	3	0.75
EPB7F-0405-04	4	+0.020/+0.068	5.5	9.5	4	0.75
EPB7F-0405-06	4	+0.020/+0.068	5.5	9.5	6	0.75
EPB7F-0506-035	5	+0.010/+0.040	6	10	3.5	0.5
EPB7F-0506-05	5	+0.010/+0.040	6	10	5	0.5
EPB7F-0506-06	5	+0.010/+0.040	6	10	6	0.5
EPB7F-0507-04	5	+0.020/+0.068	7	11	4	1
EPB7F-0507-05	5	+0.020/+0.068	7	11	5	1
EPB7F-0507-10	5	+0.020/+0.068	7	11	10	1
EPB7F-0509-05	5	+0.030/+0.105	9	13	5	2
EPB7F-0509-08	5	+0.030/+0.105	9	13	8	2
EPB7F-0608-04	6	+0.020/+0.068	8	12	4	1
EPB7F-0608-06	6	+0.020/+0.068	8	12	6	1
EPB7F-0608-07	6	+0.020/+0.068	8	12	7	1
EPB7F-0608-08	6	+0.020/+0.068	8	12	8	1
EPB7F-0608-10	6	+0.020/+0.068	8	12	10	1
EPB7F-0610-05	6	+0.030/+0.105	10	14	5	2
EPB7F-0610-06	6	+0.030/+0.105	10	14	6	2
EPB7F-0610-08	6	+0.030/+0.105	10	14	8	2
EPB7F-0610-10	6	+0.030/+0.105	10	14	10	2
EPB7F-0612-06	6	+0.030/+0.105	12	14	6	3
EPB7F-0612-10	6	+0.030/+0.105	12	14	10	3
EPB7F-0810-04	8	+0.025/+0.083	10	15	4	1
EPB7F-0810-055	8	+0.025/+0.083	10	15	5.5	1

产品编码 Part No.	d ₁ [mm]	d ₁ -公差 After fitting [mm]	d ₂ [mm]	d ₃ [d13] [mm]	L[h13] [mm]	T _{0.14} [mm]
EPB7F-0810-075	8	+0.025/+0.083	10	15	7.5	1
EPB7F-0810-08F2.5	8	+0.025/+0.083	10	15	8	2.5
EPB7F-0810-095	8	+0.025/+0.083	10	15	9.5	1
EPB7F-0810-10	8	+0.025/+0.083	10	15	10	1
EPB7F-0810-12	8	+0.025/+0.083	10	15	12	1
EPB7F-0810-15	8	+0.025/+0.083	10	15	15	1
EPB7F-0810-30	8	+0.025/+0.083	10	15	30	1
EPB7F-0812-06	8	+0.040/+0.130	12	16	6	2
EPB7F-0812-08	8	+0.040/+0.130	12	16	8	2
EPB7F-0814-06	8	+0.040/+0.130	14	18	6	3
EPB7F-1012-05	10	+0.013/+0.071	12	18	5	1
EPB7F-1012-06	10	+0.025/+0.083	12	18	6	1
EPB7F-1012-07	10	+0.025/+0.083	12	18	7	1
EPB7F-1012-08	10	+0.013/+0.071	12	18	8	1
EPB7F-1012-09	10	+0.013/+0.071	12	18	9	1
EPB7F-1012-10	10	+0.025/+0.083	12	18	10	1
EPB7F-1012-12	10	+0.025/+0.083	12	18	12	1
EPB7F-1012-15	10	+0.025/+0.083	12	18	15	1
EPB7F-1012-17	10	+0.025/+0.083	12	18	17	1
EPB7F-1014-10	10	+0.040/+0.130	14	19	10	2
EPB7F-121418-04	12	+0.032/+0.102	14	18	4	1
EPB7F-121418-08	12	+0.032/+0.102	14	18	8	1
EPB7F-1214-05	12	+0.032/+0.102	14	20	5	1
EPB7F-1214-06	12	+0.032/+0.102	14	20	6	1
EPB7F-1214-07	12	+0.032/+0.102	14	20	7	1
EPB7F-1214-09	12	+0.032/+0.102	14	20	9	1

CSB-EPB[®] Standard Specifications

EPB7\EPB3M\EPB15\EPB19\EPB23\EPB25 标准规格

产品编码 Part No.	d ₁ [mm]	d ₁ -公差 After fitting [mm]	d ₂ [mm]	d ₃ [d13] [mm]	L[h13] [mm]	T _{-0.14} [mm]
EPB7F-1214-10	12	+0.032/+0.102	14	20	10	1
EPB7F-1214-12	12	+0.033/+0.102	14	20	12	1
EPB7F-1214-15	12	+0.032/+0.102	14	20	15	1
EPB7F-1214-17	12	+0.032/+0.102	14	20	17	1
EPB7F-1214-20	12	+0.032/+0.102	14	20	20	1
EPB7F-1216-10	12	+0.050/+0.160	16	22	10	2
EPB7F-1216-20	12	+0.050/+0.160	16	22	20	2
EPB7F-1416-10	14	+0.016/+0.086	16	22	10	1
EPB7F-1416-12	14	+0.032/+0.102	16	22	12	1
EPB7F-1416-17	14	+0.032/+0.102	16	22	17	1
EPB7F-1420-10	14	+0.050/+0.160	20	25	10	3
EPB7F-1517-04	15	+0.032/+0.102	17	23	4	1
EPB7F-1517-05	15	+0.032/+0.102	17	23	5	1
EPB7F-1517-09	15	+0.032/+0.102	17	23	9	1
EPB7F-1517-12	15	+0.032/+0.102	17	23	12	1
EPB7F-1517-17	15	+0.032/+0.102	17	23	17	1
EPB7F-1517-20	15	+0.032/+0.102	17	23	20	1
EPB7F-1618-04	16	+0.032/+0.102	18	24	4	1
EPB7F-1618-06	16	+0.032/+0.102	18	24	6	1
EPB7F-1618-09	16	+0.032/+0.102	18	24	9	1
EPB7F-1618-12	16	+0.032/+0.102	18	24	12	1
EPB7F-1618-17	16	+0.032/+0.102	18	24	17	1
EPB7F-1618-20	16	+0.032/+0.102	18	24	20	1
EPB7F-1618-25	16	+0.032/+0.102	18	24	25	1
EPB7F-1820-09	18	+0.016/+0.086	20	26	9	1
EPB7F-1820-12	18	+0.016/+0.086	20	26	12	1
EPB7F-1820-17	18	+0.032/+0.102	20	26	17	1
EPB7F-1820-20	18	+0.032/+0.102	20	26	20	1
EPB7F-1820-22	18	+0.032/+0.102	20	26	22	1
EPB7F-1820-32	18	+0.032/+0.102	20	26	32	1
EPB7F-2022-20	20	+0.040/+0.124	22	29	20	1.5
EPB7F-2023-07	20	+0.040/+0.124	23	30	7	1.5

产品编码 Part No.	d ₁ [mm]	d ₁ -公差 After fitting [mm]	d ₂ [mm]	d ₃ [d13] [mm]	L[h13] [mm]	T _{-0.14} [mm]
EPB7F-2023-11.5	20	+0.040/+0.124	23	30	11.5	1.5
EPB7F-2023-16.5	20	+0.040/+0.124	23	30	16.5	1.5
EPB7F-2023-21.5	20	+0.040/+0.124	23	30	21.5	1.5
EPB7F-2224-16	22	+0.040/+0.124	24	30	16	1
EPB7F-2224-20	22	+0.040/+0.124	24	30	20	1
EPB7F-2528-11.5	25	+0.040/+0.124	28	35	11.5	1.5
EPB7F-2528-16.5	25	+0.040/+0.124	28	35	16.5	1.5
EPB7F-2528-21.5	25	+0.040/+0.124	28	35	21.5	1.5
EPB7F-2532-20	25	+0.065/+0.195	32	38	20	4
EPB7F-2532-30	25	+0.065/+0.195	32	38	30	4
EPB7F-3034-16	30	+0.040/+0.124	34	42	16	2
EPB7F-3034-26	30	+0.040/+0.124	34	42	26	2
EPB7F-3034-37	30	+0.040/+0.124	34	42	37	2
EPB7F-3038-20	30	+0.065/+0.195	38	44	20	4
EPB7F-3236-16	32	+0.050/+0.150	36	40	16	2
EPB7F-3236-26	32	+0.050/+0.150	36	40	26	2
EPB7F-3539-09	35	+0.050/+0.150	39	47	9	2
EPB7F-3539-16	35	+0.050/+0.150	39	47	16	2
EPB7F-3539-26	35	+0.050/+0.150	39	47	26	2
EPB7F-3539-40	35	+0.050/+0.150	39	47	40	2
EPB7F-4044-14	40	+0.025/+0.125	44	52	14	2
EPB7F-4044-30	40	+0.050/+0.150	44	52	30	2
EPB7F-4044-40	40	+0.025/+0.125	44	52	40	2
EPB7F-4044-50	40	+0.025/+0.125	44	52	50	2
EPB7F-4550-50	45	+0.050/+0.150	50	58	50	2
EPB7F-5055-40	50	+0.050/+0.150	55	63	40	2
EPB7F-5055-50	50	+0.050/+0.150	55	63	50	2
EPB7F-6065-30	60	+0.030/+0.150	65	75	30	2
EPB7F-6065-60	60	+0.060/+0.180	65	73	60	2
EPB7F-7075-40	70	+0.030/+0.150	75	83	40	2

*d₁公差为压入标准H7座孔（符合ISO3547-1）后公差

*Tolerance d₁ after fitting into housing H7 (ISO3547-1)

垫片 Metric thrust washers

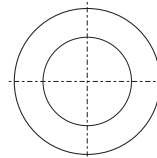
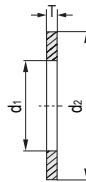

产品编码 Part No.:
EPB7W-0818-015

d_1 d_2 T
 垫片 Washer
 材料 Material

产品编码 Part No.	d ₁ ^{+0.25} [mm]	d ₂ ^{-0.25} [mm]	T ^{-0.05} [mm]
EPB7W-0509-006	5	9	0.6
EPB7W-0615-015	6	15	1.5
EPB7W-0620-015	6	20	1.5
EPB7W-0815-005	8	15	0.5
EPB7W-0815-015	8	15	1.5
EPB7W-0818-010	8	18	1.0
EPB7W-0818-015	8	18	1.5
EPB7W-1018-010	10	18	1.0
EPB7W-1018-015	10	18	1.5
EPB7W-1018-020	10	18	2.0
EPB7W-1224-015	12	24	1.5
EPB7W-1426-015	14	26	1.5
EPB7W-1524-015	15	24	1.5
EPB7W-1630-015	16	30	1.5

产品编码 Part No.	d ₁ ^{+0.25} [mm]	d ₂ ^{-0.25} [mm]	T ^{-0.05} [mm]
EPB7W-1832-015	18	32	1.5
EPB7W-2036-015	20	36	1.5
EPB7W-2238-015	22	38	1.5
EPB7W-2442-015	24	42	1.5
EPB7W-2640-0075	26	40	0.75
EPB7W-2644-015	26	44	1.5
EPB7W-2848-015	28	48	1.5
EPB7W-3254-015	32	54	1.5
EPB7W-3862-015	38	62	1.5
EPB7W-4266-015	42	66	1.5
EPB7W-4874-020	48	74	2.0
EPB7W-5278-020	52	78	2.0
EPB7W-6290-020	62	90	2.0

*根据要求提供定位孔设计 The fixing bore design upon request

EPB

CSB-EPB[®]

www.csb-ep.com
sales@csb-ep.com

Tel: 0086 573 84186133/84185527
Fax: 0086 573 84185517