

PLASTIC BEARINGS TECHNOLOGY

塑料轴承技术





...高性能聚合物技术 为客户创造价值

...High-performance Polymer Technologies Creating Value For Customers

- 成立于1995年，总注册资本2.23亿人民币；
- 年营业额超过10亿元人民币，超1000名员工；
- 拥有5个生产基地，总占地超200000m²；
- 国家级高新技术企业，超120项专利；
- IATF16949:2016、ISO9001:2015、ISO14001:2015、ISO45001:2018认证。
- CSB was established in 1995 and its legal registered capital is 223 million RMB.
- Annual turnover more than 1 Billion RMB, more than 1000 employees.
- CSB has 5 production bases with a total area of 200000m².
- China National Hi-Tech Enterprise, more than 120 patents.
- IATF16949: 2016、ISO9001: 2015、ISO14001: 2015 and ISO45001: 2018 certifications.

RoHS指令限制的十种有害物质 EC Directive 2011/65/EU (the RoHS Directive)

汞Hg、六价铬Cr⁶⁺、铅Pb、镉Cd、多溴联苯醚PBDE、多溴联苯PBB、邻苯二甲酸二正丁酯DBP、邻苯二甲酸正丁基苄酯BBP、邻苯二甲酸(2-己基)己酯DEHP、六溴环十二烷HBCDD。

This directive restricts the use of hazardous substances. Listed below are CSB products which are all RoHS compliant.



"CSB", "CSB-EPB", "CSB-LIN", "CSB-BAL", "TEFPLAS", "DURARUB", "DURAFILM", "DURAPLAS", "DURAMOV", "FLEXMOV", "DURACABLE", "DURACHAIN", "TRIBOPAD" and "TRIBOTAPE" are legally protected trademarks in China. 中国保护商标。

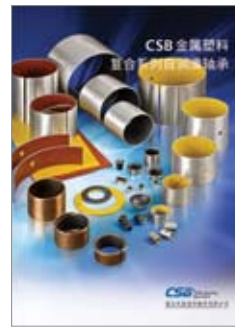

Polymer-tech Solutions™

聚合物技术 解决方案



CSB-EPB® 工程塑料轴承 Plastic Plain Bearings

自润滑免维护、耐腐蚀、长服务寿命、轻量化；可选：极低摩擦系数、高载荷、抗静电、高温250°C、FDA 食品安全等级。

Maintenance-free dry operation, Absolute corrosion resistance, Long service time and light; Multiple choices: Lowest friction coefficient, High load, Anti-static, High temperature 250°C, FDA food safety grade.



CSB-LIN® 塑料直线轴承 Plastic Linear Bearings

干运行无需供油、抗粉尘、无噪音、耐腐蚀、长服务寿命、轻量化；可选：高温250°C、多种安装方式。

Dry operation without oil, Anti-dust, No noise, Corrosion resistance, Longer service time and light; Multiple Assemble types, Highest operation temperature 250°C.



CSB-LIN® 直线导轨丝杆 Guide Rails and Lead Screws

自润滑免维护直线驱动系统，直线滑动部件及丝杆螺母均采用高耐磨EPB13材料制成，实现长期干摩擦，低噪音，长服务寿命，适合在粉尘或污水下运行。

Self-lubricating and maintenance-free linear motion system, Linear slider and screw nuts are made of high wear-resistant material EPB13, Dry operation for longer time, lower noise, longer service time and suitable for operation in dust or dirty water.



CSB-BAL® 塑料关节轴承 Plastic Spherical Bearings

自润滑免维护、耐腐蚀、抗污垢、轻量化；可选：多种结构设计满足不同安装需求。

Self-lubricating and maintenance-free, Corrosion-resistant, Anti-fouling, lightweight; Multiple structural design to meet different installation requirements.



CSB-FWB® 纤维缠绕轴承 Filament-wound Bearings

连续长纤维复合材料、干摩擦性能更优越、极高的承载能力、最高静载荷240MPa，特别适用于高载低速下的摆动。

Long fiber composite material, The best performance for dry operation, High load capacity and max. static load 240MPa, Especially suitable for swing with high load and low speed.



DURAPLAS® 耐磨半成品 Semi-finished Products

采用CSB-EPB®高耐磨材料制成，可实现非标轴承的快速加工、小批量制作降低成本；可选：棒材、板材、片材。

The semi-finished products are made of anti-wear and high performance materials CSB-EPB®, It can be machined non-standard bearings in short time, saving cost for small quantity; Multiple choices: Bar, sheet and tribo-tape.



DURAMOV® 塑料电缆拖链 Plastic Cable Carriers

采用高强度耐磨工程塑料制成，可实现多种运动方式与行程，模块化设计易于组装和维护，适用于各类环境下低噪音长寿命运行。

The cable carriers are made of high strength and anti-wear plastics, The cable carriers are used in a variety of motion modes and strokes, modular design is easy to assemble and maintain, and it is suitable for low noise long life in various environments.



FLEXMOV® 柔性电缆 Flexible Cables

FLEXMOV® 高柔性电缆包含控制电缆、数据电缆、伺服电缆、动力电缆、总线电缆、机器人电缆等；多种护套材料如PVC、PUR和TPE可满足室内或室外等极端环境无故障运行。

FLEXMOV® flexible cables include control cables, data cables, servo cables, motor cables, bus cables, robot cables, etc.; Various jacket materials such as PVC, PUR and TPE are available to meet trouble-free operation in extreme environments such as indoors or outdoors.

<http://www.csb-ep.com>

Products
Plastic Plain Bearings

www.csb-ep.com
sales@csb-ep.com

电话: 0573 84186133/84185527
Tel: 0086 573 84187009

CSB Product Family

CSB产品

Polymer-tech Solutions™

CSB-EPB® 工程塑料轴承 Plastic Plain Bearings



CSB-LIN® 塑料直线轴承 Plastic Linear Bearings



CSB-PRB® 塑料滚动轴承 Plastic Ball Bearings



CSB-BAL® 塑料关节轴承 Plastic Spherical Bearings



CSB-LMS® 直线驱动系统 Linear Motion Systems



CSB-SRB® 回转支撑轴承 Slewing Ring Bearings



CSB-RPM® 转向器轴承 Steering Rack Bearings



CSB-ALB® 高速滑动轴承 High Speed Sliding Bearings



KER 转角轴承 Knife Edge Rollers



CSB-PEC® 扶梯回转链 Escalator Rotary Chains



工程塑料电缆拖链 Plastic Cable Chains



CSB-SFP® 耐磨半成品 Semi-finished Products

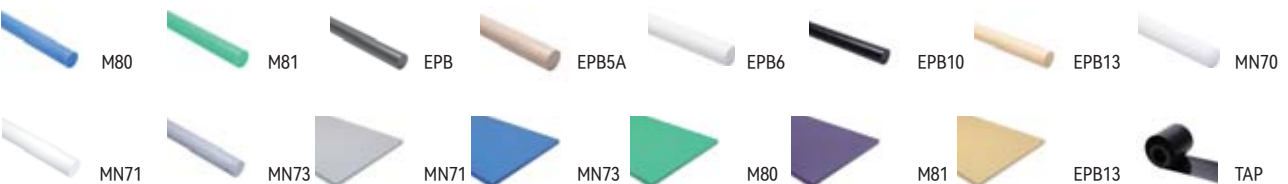

CSB-FWB® 纤维缠绕轴承 Filament-wound Bearings



金属自润滑轴承 Metal Sliding Bearings

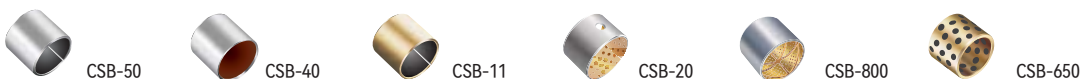

Plastic Plain Bearings

www.csb-ep.com
sales@csb-ep.com

电话: 0573 84186133/84185527
Tel: 0086 573 84187009

Home / CSB standard products / Plastic plan bearings tool V2.0

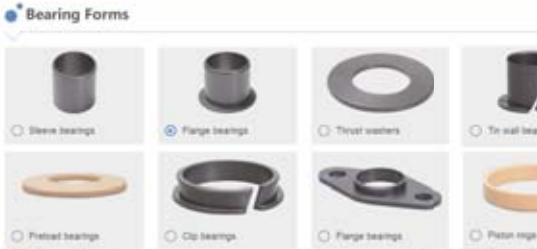

Operating data

Max. static load at 23°C: MPa

Max. dynamic load at 23°C: MPa

Max. long-term operating temp.: °C

Min. long-term operating temp.: °C

Other requirements

- Anti-static
- FDA certification
- Flammability class V0
- Lowest friction coefficient
- Cost-effective

CSB suitable products

<input checked="" type="checkbox"/> CSB-EP9	<input checked="" type="checkbox"/> CSB-EP61	<input checked="" type="checkbox"/> CSB-EP62	<input checked="" type="checkbox"/> CSB-EP63	<input checked="" type="checkbox"/> CSB-EP64
<input checked="" type="checkbox"/> CSB-EP65	<input checked="" type="checkbox"/> CSB-EP66	<input checked="" type="checkbox"/> CSB-EP67	<input checked="" type="checkbox"/> CSB-EP68	<input checked="" type="checkbox"/> CSB-EP69
<input checked="" type="checkbox"/> CSB-EP70	<input checked="" type="checkbox"/> CSB-EP71	<input checked="" type="checkbox"/> CSB-EP72	<input checked="" type="checkbox"/> CSB-EP73	<input checked="" type="checkbox"/> CSB-EP74
<input checked="" type="checkbox"/> CSB-EP75	<input checked="" type="checkbox"/> CSB-EP76	<input checked="" type="checkbox"/> CSB-EP77	<input checked="" type="checkbox"/> CSB-EP78	<input checked="" type="checkbox"/> CSB-EP79
<input checked="" type="checkbox"/> CSB-EP80	<input checked="" type="checkbox"/> CSB-EP81	<input checked="" type="checkbox"/> CSB-EP82	<input checked="" type="checkbox"/> CSB-EP83	<input checked="" type="checkbox"/> CSB-EP84
<input checked="" type="checkbox"/> CSB-EP85	<input checked="" type="checkbox"/> CSB-EP86	<input checked="" type="checkbox"/> CSB-EP87	<input checked="" type="checkbox"/> CSB-EP88	<input checked="" type="checkbox"/> CSB-EP89
<input checked="" type="checkbox"/> CSB-EP90	<input checked="" type="checkbox"/> CSB-EP91	<input checked="" type="checkbox"/> CSB-EP92	<input checked="" type="checkbox"/> CSB-EP93	<input checked="" type="checkbox"/> CSB-EP94
<input checked="" type="checkbox"/> CSB-EP95	<input checked="" type="checkbox"/> CSB-EP96	<input checked="" type="checkbox"/> CSB-EP97	<input checked="" type="checkbox"/> CSB-EP98	<input checked="" type="checkbox"/> CSB-EP99

Stacks
 Lead line 2x4x

Home / CSB 标准产品 / 塑料直线轴承查找器 V1.0

产品选择

LMS滑道线性轴承

基础轴承

20mm



运行参数

轴径/轴径W: mm 平均线速度Vavg: m/s

轴套数Cs: 轴间距Ls: mm

单轴轴套间距Cs: 轴间距SLS: mm

安装方式: H/P V/直 D/P

负载距中心W中心: vx: mm vy: mm wz: mm

驱动力距P中心: rx: mm rz: mm

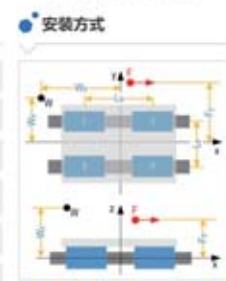

设计分析

安装扭矩: 运动警告: 建议优化驱动力的中心距

负载扭矩: 安全负载

速度扭矩: 安全速度

最小驱动力: 500 N

最低温度Tmin.: -50°C

最高温度Tmax.: +90°C



Home / CSB standard products / Flament-wound bearings tool V3.0



Operating data

Max. static load at 23°C: MPa

Max. dynamic load at 23°C: MPa

Max. long-term operating temp.: °C

Min. long-term operating temp.: °C

Other requirements

- Cost-effective
- Flaming the cover hole open

CSB suitable products

CSB-L06 CSB-L08 CSB-L10 CSB-L12 CSB-L14 CSB-L16

CSB-L18

Stacks
 Lead line 2x4x

在线工具 Online Tools ▶▶▶▶▶▶▶▶

▶▶▶▶▶▶▶▶ 请登录我们的网站查询 please visit: www.csb-ep.com

CSB-EPB[®] Plastic Plain Bearings

CSB-EPB[®] 工程塑料轴承

基本功能 Basic function			
通用型 General		CSB-EPB 通用性更强 The most common material	CSB-EPB1 特别适合用于卡车尾箱铰链 Especially suitable for truck hinges
		CSB-EPB3 增强型 高承载 Enhanced type	
高载型 High load		CSB-EPB12 特别适合高载下摇摆运动 Especially suitable for oscillation	CSB-EPB22 极高载荷耐磨材料 Good wear resistance under extremely high load
		CSB-EPB5 耐高温 抗化学性极佳 High temperature Excellent chemical resistance	
耐高温 High temperature		CSB-EPB4 耐温200°C Work consecutively at 200°C	CSB-EPB24 耐温200°C 适用于燃油系统 Temperature up to 200°C For use in fuel oil
		CSB-EPB5 耐温250°C 高化学抗性 Work consecutively at 250°C, Good chemical resistance	
低摩擦系数 Low friction coefficient		CSB-EPB13 快慢速下保持较低的摩擦系数 Maintain low friction coefficient either at high or low speed	CSB-EPB7 适合高速运动 高耐磨性 Suitable for high speed High wear resistance
		CSB-EPB11 不含PTFE和硅, 轻载 耐磨性极好, 高抗冲击性, 适合软轴 Not PTFE and Silicon. Good wear resistance for low load. Suitable for soft shaft	
耐腐蚀 Anti-corrosion		CSB-EPB4 耐温200°C Work consecutively at 200°C	CSB-EPB5 耐温250°C 耐腐蚀更强 Work consecutively at 250°C Highest corrosion resistance
		CSB-EPB8 耐温200°C 水下运行专用 Work consecutively at 200°C, Specialized underwater operation	
潮湿环境 Humid environment		CSB-EPB2 适合潮湿环境 Good for Humidity condition	CSB-EPB4 高强度, 耐化学腐蚀 High strength Good chemical resistance
		CSB-EPB8 适合水下运行 Underwater operation	
食品安全等级FDA grade		CSB-EPB5A 耐温250°C FDA食品等级认可 High temperature 250°C FDA grade	CSB-EPB6 适合软轴 允许接触食品 Soft shaft available Food-classic
		CSB-EPB6A 用于食品或烟草行业, 适合低速运动 For the food and tobacco industry, Low speed	
经济型 Economic		CSB-EPBH 经济通用 General Type	CSB-EPB2D 低摩擦系数, 更经济 Low Friction coefficient Low cost
		CSB-EPB3G 高强度 High strength	

Plastic Plain Bearings
工程塑料轴承

www.csb-ep.com
sales@csb-ep.com

电话: 0573 84186133/84185527
Tel: 0086 573 84187009

 <p>CSB-EPB7 高耐磨性, 电梯行业应用, 适合软轴 High wear resistance, Used in lift industry, Suitable for soft shaft</p>	 <p>CSB-EPB13 适合快慢速、适合软轴 Suitable for high and low speed with soft shaft</p>	 <p>CSB-EPB15 高耐磨 长寿命 High wear resistance Long service life</p>	 <p>CSB-EPB18 低吸水性, 高耐磨 Low water absorption, Good wear resistance</p>
 <p>CSB-EPB5Z 特别适合摇摆运动 Especially suitable for oscillation</p>	 <p>CSB-EPB10 耐高温, 高强度 抗化学性极好 High temperature Excellent chemical resistance</p>		
 <p>CSB-EPB10 耐温250°C, 高强度 Work consecutively at 250°C High strength</p>	 <p>CSB-EPB21 高温耐磨材料 Good wear resistance for high temperature</p>	 <p>CSB-EPB26 适合高温和软轴应用 For soft shafts and high temperatures</p>	 <p>CSB-EPB8 耐温200°C 水下运行专用 Work consecutively at 200°C, Specialized underwater operation</p>
 <p>CSB-EPB18 低吸水性, 高耐磨 Low water absorption, Good wear resistance</p>	 <p>CSB-EPB15 高耐磨 长寿命 High wear resistance Long service life</p>	 <p>CSB-EPB5Z 特别适合摇摆运动 Especially suitable for oscillation</p>	 <p>CSB-EPB 通用性更强 The most common material</p>
 <p>CSB-EPB10 耐温250°C 高抗压强度 Work consecutively at 250°C, High compressive strength</p>	 <p>CSB-EPB26 适合高温和软轴应用 For soft shafts and high temperatures</p>	 <p>CSB-EPB5Z 特别适合摇摆运动 Especially suitable for oscillation</p>	
 <p>CSB-EPB16 适合高载荷 Suitable for high load</p>	 <p>CSB-EPB20 水下的自润滑材料 A self-lubricating material for applications in water</p>	 <p>CSB-EPB21 高温耐磨材料 Good wear resistance for high temperature</p>	 <p>CSB-EPB1 特别适用于卡车尾箱铰链 Especially suitable for truck hinges</p>
 <p>CSB-EPB11 不含PTFE和硅, 轻载 耐磨性极好, 高冲击性, 适合软轴 Not PTFE and Silicon. Good wear resistance for low load. Suitable for soft shaft</p>	 <p>CSB-EPB23 高温180°C食品行业应用 For use with temperatures up to 180°C</p>		
 <p>CSB-EPB3M 边缘载荷, 耐冲压, 适合低速运动 Marginal Load, Impact resistance, Low speed</p>			

CSB-EPB[®] Material Properties Data Table

CSB-EPB[®] 材料数据表

材料性能 Material properties	测试标准 Standard	单位 Unit	EPB	EPB1	EPB2	EPB2D	EPB3	EPB3G
一般性能 General properties								
颜色 Color	-	-	深灰 Dark grey	棕色 Brown	橄榄绿 Olive	绿色 Green	深灰 Dark grey	黑色 Black
密度 Density	ISO1183	g/cm ³	1.46	1.53	1.39	1.40	1.46	1.37
最大吸湿率 Max. moisture absorption, 50%RH	ISO62	%	0.3	0.2	0.2	0.3	0.7	1.3
最大吸水率 Max. water absorption	ISO62	%	1.2	0.5	0.4	1.2	4.0	5.5
对钢动摩擦系数 Coefficient of sliding friction(steel)	ITS025	μ	0.05-0.15	0.08-0.20	0.07-0.20	0.05-0.25	0.08-0.18	0.05-0.15
极限PV值 Max. PV value	ITS026	N/mm ² ×m/s	0.40	0.50	0.45	0.25	0.45	0.30
机械性能 Mechanical properties								
弯曲模量 Flexural modulus	ISO178	MPa	2300	2600	2400	2000	8500	7700
弯曲强度 Flexural strength	ISO178	MPa	60	65	60	65	210	190
最大静载荷 Max. static load	ITS027	MPa	35	55	50	30	80	75
最大动载荷 Max. dynamic load	ITS028	MPa	15	21	19	13	43	36
邵氏硬度 Shore hardness	ISO868	D	75	72	72	75	81	78
物理和热性能 Physical and thermal properties								
连续运行温度 Long-term application temperature	ITS029	°C	+80	+110	+100	+80	+130	+100
短时运行温度 Short-term application temperature	ITS029	°C	+120	+160	+150	+120	+220	+160
最低运行温度 Lowest application temperature	ITS029	°C	-40	-40	-40	-40	-40	-40
导热性 Thermal conductivity	ISO22007	W/m/K	0.20	0.26	0.25	0.25	0.24	0.24
线性热膨胀系数 Coefficient of thermal expansion	ISO11359	K ¹ ×10 ⁻⁵	10	8	10	11	9	11
阻燃等级 Flammability	UL94	Class	HB	HB	HB	HB	HB	HB
导电性能 Electrical properties								
体电阻率 Volume resistance	IEC60093	Ω·cm	>10 ¹³	>10 ¹¹	>10 ¹²	>10 ¹³	>10 ¹³	>10 ¹²
面电阻率 Surface resistance	IEC60093	Ω	>10 ¹²	>10 ¹⁰	>10 ¹¹	>10 ¹²	>10 ¹¹	>10 ¹¹

*ITS: CSB内部测试标准 CSB company's internal test standards.

**除非特殊说明测试温度为23°C Test temperatures are 23°C unless otherwise stated.

EPB3M	EPB4	EPB5	EPB5A	EPB5Z	EPB6	EPB6A	EPB7	EPB8	EPB9	EPB10	EPB11
深灰 Dark grey	黑色 Black	黑色 Black	米色 Beige	棕色 Brown	白色 White	白色 White	米黄 Cream	深灰 Dark grey	黑色 Black	黑色 Black	白色 White
1.14	1.70	1.44	1.28	1.40	1.45	1.10	1.25	1.55	1.28	1.42	0.96
1.4	0.1	0.1	0.3	0.3	0.3	1.5	1.3	0.1	1.3	0.1	0.1
7.6	0.3	0.5	0.5	1.1	1.2	7.6	6.5	0.1	6.5	0.5	0.1
0.09-0.30	0.07-0.20	0.09-0.25	0.25-0.40	0.05-0.15	0.05-0.18	0.10-0.40	0.09-0.20	0.07-0.18	0.10-0.40	0.10-0.25	0.05-0.15
0.15	1.35	1.40	0.25	1.00	0.30	0.10	0.50	0.80	0.35	1.35	0.20
2700	12000	4800	3600	4200	2300	1300	3200	8000	10000	10000	1200
100	165	165	140	150	60	55	75	150	250	210	25
30	90	110	90	100	35	35	60	85	105	125	25
15	50	61	46	51	14	12	25	47	58	80	6
79	82	82	80	80	74	70	75	82	82	86	62
+80	+200	+250	+250	+250	+80	+80	+90	+200	+140	+250	+70
+170	+240	+315	+300	+310	+120	+170	+180	+240	+180	+315	+100
-40	-40	-100	-100	-100	-40	-40	-40	-40	-40	-100	-100
0.24	0.60	0.55	0.24	0.55	0.20	0.23	0.24	0.50	0.60	0.60	0.20
10	4	6	9	5	10	11	9	5	11	5	19
HB	V0	V0	V0	V0	HB	HB	HB	V0	HB	V0	HB
>10 ¹²	>10 ⁵	>10 ⁸	>10 ¹⁴	>10 ¹¹	>10 ¹³	>10 ¹³	>10 ¹³	>10 ⁵	<10 ³	>10 ⁵	>10 ¹³
>10 ¹¹	>10 ⁵	>10 ⁷	>10 ¹³	>10 ¹¹	>10 ¹²	>10 ¹²	>10 ¹²	>10 ⁵	<10 ³	>10 ⁵	>10 ¹²

CSB-EPB[®] Material Properties Data Table

CSB-EPB[®] 材料数据表

材料性能 Material properties	测试标准 Standard	单位 Unit	EPB12	EPB13	EPB15	EPB16	EPB18	EPB19
一般性能 General properties								
颜色 Color	-	-	黑色 Black	黄色 Yellow	黄色 Yellow	黑色 Black	黄色 Yellow	深灰 Dark grey
密度 Density	ISO1183	g/cm ³	1.32	1.48	1.30	1.60	1.40	1.27
最大吸湿率 Max. moisture absorption, 50%RH	ISO62	%	0.9	0.3	1.3	0.2	0.3	1.3
最大吸水率 Max. water absorption	ISO62	%	4.9	1.3	6.5	0.4	0.5	4.5
对钢动摩擦系数 Coefficient of sliding friction(steel)	ITS025	μ	0.05-0.20	0.05-0.15	0.05-0.15	0.06-0.20	0.05-0.18	0.05-0.20
极限PV值 Max. PV value	ITS026	N/mm ² ×m/s	0.55	0.40	0.90	0.40	0.40	0.60
机械性能 Mechanical properties								
弯曲模量 Flexural modulus	ISO178	MPa	2200	2600	4000	4900	2700	2800
弯曲强度 Flexural strength	ISO178	MPa	100	60	130	140	65	80
最大静载荷 Max. static load	ITS027	MPa	75	35	70	75	50	60
最大动载荷 Max. dynamic load	ITS028	MPa	43	14	35	38	21	22
邵氏硬度 Shore hardness	ISO868	D	83	74	79	80	75	72
物理和热性能 Physical and thermal properties								
连续运行温度 Long-term application temperature	ITS029	°C	+135	+90	+90	+130	+100	+150
短时运行温度 Short-term application temperature	ITS029	°C	+155	+120	+180	+200	+160	+200
最低运行温度 Lowest application temperature	ITS029	°C	-40	-50	-40	-40	-40	-40
导热性 Thermal conductivity	ISO22007	W/m/K	0.24	0.25	0.24	0.25	0.25	0.25
线性热膨胀系数 Coefficient of thermal expansion	ISO11359	K ⁻¹ ×10 ⁻⁵	5	10	8	4	8	10
阻燃等级 Flammability	UL94	Class	HB	HB	HB	HB	HB	HB
导电性能 Electrical properties								
体电阻率 Volume resistivity	IEC60093	Ω·cm	>10 ¹¹	>10 ¹³	>10 ¹³	>10 ¹³	>10 ¹²	>10 ¹³
面电阻率 Surface resistivity	IEC60093	Ω	>10 ¹¹	>10 ¹²	>10 ¹²	>10 ¹²	>10 ¹¹	>10 ¹¹

*ITS: CSB内部测试标准 CSB company's internal test standards.

**除非特殊说明测试温度为23°C Test temperatures are 23°C unless otherwise stated.

	EPB20	EPB21	EPB22	EPB23	EPB24	EPB25	EPB26	EPBH	MN2	MN3	MN9	MR4
	黑色 Black	米色 Beige	浅棕色 Light brown	蓝色 Blue	棕色 Brown	黄色 Yellow	米色 Beige	黑色 Black	深灰 Dark grey	浅黄色 Light yellow	黑色 Black	灰色 Grey
	1.53	1.53	1.49	1.42	1.72	1.44	1.51	1.43	1.65	1.42	1.45	1.48
	0.2	0.1	1.1	0.6	0.1	0.3	0.1	0.3	0.2	0.3	0.2	0.3
	0.8	0.3	4.6	1.9	0.2	1.6	0.2	1.2	0.7	1.3	0.4	1.3
	0.15-0.35	0.05-0.20	0.15-0.35	0.10-0.20	0.08-0.25	0.08-0.20	0.15-0.20	0.05-0.20	0.10-0.18	0.05-0.20	0.15-0.25	0.05-0.20
	0.15	0.80	0.70	0.40	0.60	0.45	0.50	0.30	0.30	0.50	0.40	0.30
	7200	2800	9000	2000	10000	4500	4500	2000	2400	2700	2000	2350
	120	55	240	110	210	100	95	60	53	70	70	60
	70	80	95	60	110	60	55	30	30	45	65	35
	35	37	49	26	58	30	22	12	12	24	29	19
	79	77	80	76	81	79	74	74	73	73	76	74
	+90	+200	+150	+180	+200	+180	+200	+80	+90	+90	+120	+90
	+110	+240	+220	+210	+240	+220	+240	+120	+120	+120	+165	+120
	-50	-40	-40	-100	-40	-100	-40	-40	-50	-50	-40	-50
	0.60	0.24	0.24	0.24	0.24	0.24	0.24	0.20	0.24	0.25	0.60	0.25
	6	6	8	8	5	7	3	10	8	13	5	10
	HB	V0	HB	V0	V0	V0	V0	HB	HB	HB	HB	HB
	<10 ⁵	>10 ¹²	>10 ¹³	>10 ¹¹	>10 ¹³	>10 ¹³	>10 ¹²	>10 ¹³	>10 ⁸	>10 ¹²	<10 ⁹	>10 ¹³
	<10 ⁵	>10 ¹¹	>10 ¹¹	>10 ¹¹	>10 ¹²	>10 ¹⁰	>10 ¹²	>10 ¹²	>10 ⁸	>10 ¹²	<10 ⁹	>10 ¹²

CSB-EPB[®] Plastic Plain Bearings

CSB-EPB[®] 工程塑料轴承

EPB 工程塑料轴承 Plastic plain bearings



产品特性 Product features

- CSB-EPB[®]工程塑料轴承采用高性能的工程塑料为基础原料，通过高分子材料改性复合技术添加高强度纤维和特种固体润滑脂提升复合材料的耐磨性能；高强度纤维网状结构加强了材料的强度，特种固体润滑脂的复合使得EPB工程塑料轴承具有极好的自润滑性能和耐磨性能。
- 无论是耐久性要求很高的汽车工业、高速应用、水下应用、高温和抗腐蚀应用或是要求符合FDA标准的食品工业CSB[®]总能为客户提供不同的解决方案。
- CSB-EPB[®] Plastic plain bearings use high-performance plastics as the raw material, and filled high-strength fibers and special solid lubricants by the polymer compound technology to improve the anti-wear resistance of composite materials.
- In the automotive industry with high durability requirements, high-speed applications, underwater applications, high temperature and anti-corrosion applications, or the food industry with FDA requirement, CSB[®] can always provide different solutions for customers.

- 直筒轴承、法兰轴承、垫片
Sleeve bearings, Flange bearings, Thrust washers
- 内径 Inner diameters: Ø2mm-Ø150mm

PCB 塑料卡箍轴承 Plastic clip bearings



产品特性 Product features

- 专门为金属薄板配合开发的自润滑塑料轴承。安装简易。使用避震和耐磨性能相结合的CSB-EPB3M材料制成。可提供耐高温和耐腐蚀材料CSB-EPB5制成的轴承
- 免维护，自润滑
- 侧面开槽设计，易于安装
- 开槽设计可补偿材料膨胀
- 双法兰设计更安全
- 适用于旋转和直线运动
- 对安装孔精度要求较低
- The self-lubricated bearing is developed specially for the metal plate fitting. It is made with the CSB-EPB3M material which is good at shock absorption and wear resistance. Alternative material CSB-EPB5 is also available for high temperature application and corrosion resistance requirement
- Maintenance free, self-lubricated
- Side groove designation for easy assembly
- Groove design reserves the material expansion allowance
- Safety double flanges designation
- Suitable for rotation and sliding motions
- Lower tolerance requirement for the mounting holes

- 内径 Inner diameters: Ø3mm-Ø25mm

*请扫描二维码登录我们的网站查询 Please scan the QR code to log in to our website: www.csb-ep.com

PYB 薄壁塑料轴承 Plastic bearings

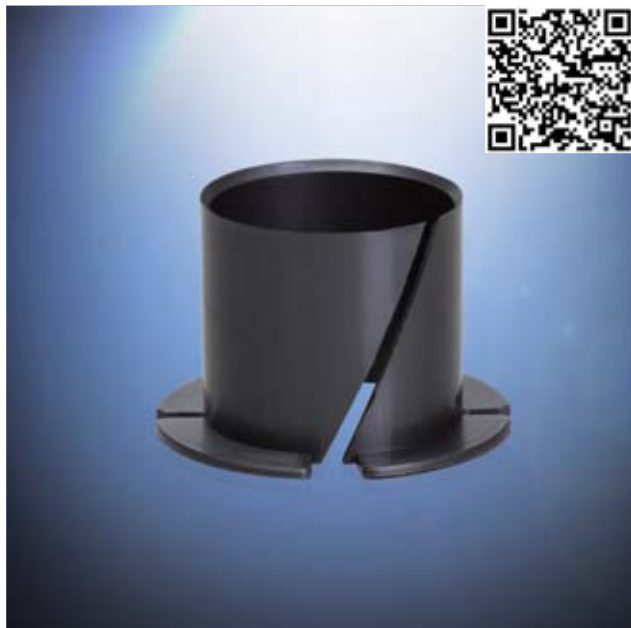

● 内径 Inner diameters: Ø4mm-Ø25mm

产品特性 Product features

- 快速安装的薄壁塑料轴承。采用尺寸适应性较好的CSB-EPB3M材料制成。同样可提供耐磨性能更为出色的CSB-EPB7材料
- 免维护，自润滑
- 侧面开槽设计，易于安装
- 开槽设计可补偿材料膨胀
- 适用于旋转、摇摆运动
- 对安装孔精度要求较低
- Plastic bearing for quick installation. It is made with CSB-EPB3M material which is flexible for dimension variation. Alternative material CSB-EPB7 is also available for special wear resistance requirement
- Maintenance free, self-lubricated
- Side groove designation for easy assembly
- Groove design reserves the material expansion allowance
- Suitable for rotation and sliding motions
- Lower tolerance requirement for the mounting holes

CPB 无间隙预紧塑料轴承 Clearance-free and preloaded bearings



● 内径 Inner diameters: Ø6mm-Ø14mm

产品特性 Product features

- 无间隙预紧设计
- 自动调节装配间隙
- 自润滑免维护
- 消除振动和噪音
- EPB13耐磨材料制成
- Clearance-free and preload design
- Adjustable fitting gap
- Maintenance-free
- Shock absorbing and no noise
- Material EPB13

*请扫描二维码登录我们的网站查询 Please scan the QR code to log in to our website: www.csb-ep.com

CSB-EPB[®] Plastic Plain Bearings

CSB-EPB[®] 工程塑料轴承

FLB 法兰轴承 Flange bearings



● 内径 Inner diameters: $\varnothing 10\text{mm}-\varnothing 30\text{mm}$

产品特性 Product features

- 应用于PCB塑料卡箍轴承无法被定位的场合。对配合孔的精度要求较低。螺栓固定无滑落风险
- 免维护，自润滑
- 螺丝固定安全可靠
- 适用于旋转、摇摆、直线运动
- 对安装孔精度无要求
- EPB3或EPB13耐磨材料制成
- Suitable for the application where the plastic clip bearing is hard to be located. The requirement of the fitting hole is not critical and the set screw could be secured without any risk of moving
- Maintenance free, self-lubricated
- Bolt fixture ensures safe and reliability
- Suitable for rotation, oscillation and sliding motions
- Low tolerance requirement for the mounting holes
- Material EPB3 or EPB13

PEW 塑料板簧 Plastic flat springs



● 内径 Inner diameters: $\varnothing 5\text{mm}-\varnothing 20\text{mm}$

产品特性 Product features

- 工程塑料耐磨调整垫片。应用于轴向配合存在不可控间隙的调整。降低运动过程中的振动和噪音
- 补偿轴向间隙和加工公差
- 吸震和降低噪音
- 免维护，自润滑
- 耐腐蚀、质量轻
- EPB13耐磨材料制成
- Engineering plastic wear resistance washer. Suitable for a fitting to the uncontrollable axial space in order to reduce the vibration and noise during the operation
- Compensate the axial clearance and machining tolerance
- Shock absorbing and noise optimization
- Maintenance free and self-lubricated
- Corrosion resistance and light weight
- Material EPB13

*请扫描二维码登录我们的网站查询 Please scan the QR code to log in to our website: www.csb-ep.com

PPR 塑料活塞环 Plastic piston rings



● 内径 Inner diameters: Ø10mm-Ø70mm

产品特性 Product features

- 专门为气缸行业开发的耐磨活塞环。比PTFE制成的活塞环安装更简易。可提供CSB®标准材料EPB13、EPB19等制成的高耐磨活塞环
- 耐磨性能极好
- 装配简易
- 免维护，自润滑
- 耐腐蚀、质量轻
- Wear resistance piston ring specially developed for the pneumatic pump industrial application. It is easier to be installed comparing with the PTFE piston ring. Standard materials available are EPB13, EPB19 and so on
- Good wear resistance
- Easy assembly
- Maintenance free and self-lubricated
- Corrosion resistance and light weight

LCB 塑料卡箍直线轴承 Plastic clip linear bearings



● 内径 Inner diameters: Ø6mm-Ø12mm

产品特性 Product features

- 高耐磨材料EPB13制成
- 自润滑、免维护
- 耐腐蚀，可用于液体介质环境
- 抵抗灰尘和无噪音运行
- 易安装
- 压装后内孔E10
- 推荐座孔H7，轴h6-h9
- Made of high anti-wear material EPB13
- Maintenance-free, self lubricating
- Chemical resistant
- Dust resistant and quit running
- Installation by force fitting
- Inner tolerance E10 ensues only after the press fit
- Recommended housing bore H7, shaft: h6-h9

*请扫描二维码登录我们的网站查询 Please scan the QR code to log in to our website: www.csb-ep.com

CSB-EPB[®] Plastic Plain Bearings

CSB-EPB[®] 工程塑料轴承

ALB 高速滑动轴承 High speed sliding bearings

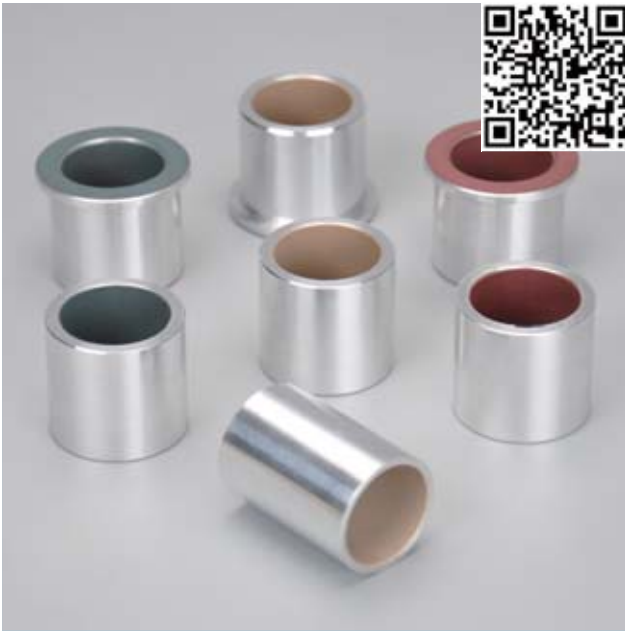

产品特性 Product features

- 滑动层标准材料TEFPLAS[®] B, 可选高耐磨与低启动摩擦料 TEFPLAS[®] G及符合FDA等级TEFPLAS[®] E 与 TEFPLAS[®] P
- 外壳材料铝合金, 可选不锈钢
- 自润滑, 免维护
- 运行平稳, 无噪音
- 高速运行, 长寿命
- 工作温度±200°C
- Standard material of sliding layer: TEFPLAS[®] B, Available materials: Lower starting friction TEFPLAS[®] G and FDA grade TEFPLAS[®] E & TEFPLAS[®] P
- Shell made of aluminum, available stainless steel
- Self-lubricating, maintenance-free
- Smooth operation, no noise
- High-speed operation and long life
- Operation temperature ±200°C

● 内径 Inner diameters: Ø8mm-Ø30mm

KER 转角轴承 Knife edge rollers



产品特性 Product features

- 自润滑、免维护
- 低驱动力
- 抗灰尘、无噪音
- 抗化学腐蚀, 可用于液体环境
- 紧凑的偏转半径
- 延长传输带寿命
- 高性价比
- Self-lubricating, maintenance-free
- Low driving force
- Resistant to dust, no noise
- Resistant to chemical corrosion, available in liquid environment
- Compact deflection radius
- Extend the life of the belt
- Cost-effective

● 内径 Inner diameters: Ø3.1mm-Ø10.1mm

*请扫描二维码登录我们的网站查询 Please scan the QR code to log in to our website: www.csb-ep.com

高性能塑料关节轴承 High polymer-tech for plastic spherical bearings



产品特性 Product features

- 自润滑、免维护
- 耐腐蚀，可用于液体介质环境
- 抵抗灰尘和污垢
- 无噪音运行
- 承受边缘载荷
- 易安装、成本低
- 壳体采用高强度材料M163，球体采用高耐磨材料EPB15
- Maintenance-free dry operation
- Absolute corrosion resistance, media resistant
- Dirt-resistant and no noise
- Compensation of misalignment errors
- Compensation of edge loads
- Easy installation and low cost
- Housing made of high strength material M163, ball made of anti-wear material EPB15

CSB-BAL[®] 球体 Spherical balls

标准球体采用高耐磨EPB15材料制成，它在干运行时具有较高的承载和极低的摩擦系数，特别适用于高载低速运动场合。CSB还可以采取其它标准耐磨材料制成球体，从而提高关节轴承的特殊使用性能。

In standard spherical ball is made from EPB15 material, which is known for its high strength and low coefficient of friction while running dry. This is especially important for low loads and very slow movements. Further to the standard material EPB15, spherical balls are now available in other materials presenting particular advantages.

CSB-BAL[®] 基座 Housings

标准基座采用高强度M163材料制成，它是纤维增强聚合物材料，具有较好的抗冲击性能，使用温度-30°C至+80°C。CSB还可以采取其它材料制成基座，比如镁铝合金和不锈钢材料等，请联系我们。

Standard housings made from M163, a long-fiber reinforced and extremely shock resistant polymer. Operation temperatures from -30°C to +80°C, It is available other materials for the housing such as aluminum alloy and stainless steel, please ask us for other materials.

载荷和温度 Loads and temperatures

在正常外界温度使用的情况下，塑料关节轴承具有较高的承载能力，尽管其重量只有金属关节轴承的1/5；塑料关节轴承由于球体和基座均采用特种塑料制成具有一定的减震性能。塑料关节轴承长期用于高载或极端温度下时我们建议通过实际实验检测。

The load capacity of the maintenance-free spherical bearing is very high at normal ambient temperatures. The weight only one fifth of metal bearing. The excellent dampening properties are based on the fact that the polymer material of the two part bearing can absorb vibrations differently than steel. The load capacity of the rod end should therefore be checked in a practical test, particularly if it will be used under continuous high loads and at elevated temperatures.

*请扫描二维码登录我们的网站查询 Please scan the QR code to log in to our website: www.csb-ep.com

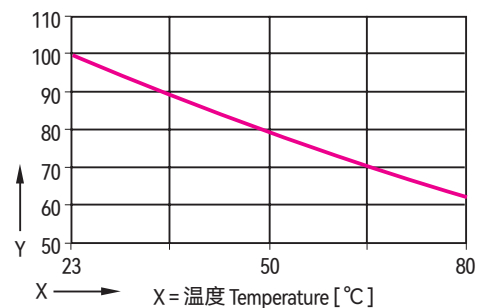

Y = 抗拉强度百分比 Percentage tensile strength [%]

温度对塑料关节轴承的最大抗拉强度的影响

Trends indicate the effect of temperature on the max. load capacity of CSB-BAL[®] bearings

CSB-BAL[®] Plastic Spherical Bearings

CSB-BAL[®] 塑料关节轴承



BAL
[Ø4mm-Ø30mm]



GLB
[Ø4mm-Ø30mm]



GLBF
[Ø20mm]



GIB
[Ø6mm-Ø12mm]



GOB
[Ø6mm-Ø10mm]



GFB
[Ø4mm-Ø30mm]



GFB-ALG
[Ø6mm-Ø30mm]



GSB
[Ø4mm-Ø30mm]



GSB-ALG
[Ø6mm-Ø30mm]



GBB
[Ø16mm-Ø30mm]



GBB-ALG
[Ø16mm-Ø30mm]



GNB
[Ø8mm-Ø30mm]



GDB
[Ø4mm-Ø12mm]



GVCE
[Ø6mm-Ø12mm]



GVCJ
[ØM8]

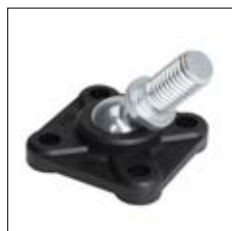

GSB-OP
[Ø6mm-Ø10mm]



GSB-IP
[Ø6mm-Ø10mm]



GC
[Ø6mm-Ø12mm]



GTB
[Ø5mm-Ø20mm]

塑料关节轴承
Plastic Spherical Bearings

www.csb-ep.com
sales@csb-ep.com

电话: 0573 84186133/84185527
Tel: 0086 573 84187009

*请扫描二维码登录我们的网站查询 Please scan the QR code to log in to our website: www.csb-ep.com

不锈钢基座关节轴承 Stainless Steel Spherical Bearings



产品特性 Product features

- 基座采用不锈钢材料，内部安装耐磨球体
 - 免维护、自润滑
 - 适合重载低速运动
 - 自动补偿安装偏差
 - 耐冲击、无噪音
 - 耐灰尘、重量轻
- Self-lubricating, maintenance-free
 - Low driving force
 - Resistant to dust, no noise
 - Resistant to chemical corrosion, available in liquid environment
 - Compact deflection radius
 - Extend the life of the belt
 - Cost-effective
 - Materials: EPB18

● 内径 Inner diameters: Ø20mm, Ø25mm, Ø30mm



SFL

[Ø20mm, Ø25mm, Ø30mm]



SF

[Ø20mm, Ø25mm, Ø30mm]



SP

[Ø20mm, Ø25mm, Ø30mm]



SPA

[Ø20mm, Ø25mm, Ø30mm]



LR

[Ø20mm, Ø25mm, Ø30mm]



BAL

[Ø20mm, Ø25mm, Ø30mm]

*请扫描二维码登录我们的网站查询 Please scan the QR code to log in to our website: www.csb-ep.com

CSB-LIN[®] Plastic Linear Bearings

CSB-LIN[®] 塑料直线轴承



产品特性 Product features

- 自润滑免维护塑料直线轴承。无噪音运行。适合在极其恶劣的粉尘环境中连续使用。允许被食品药品包装机械清洗液清洗。对轴材料硬度以及安装孔的精度要求较低
 - 免维护、长期干运行、无噪音
 - 适合灰尘中长期运行
 - 耐腐蚀，适合用消毒液清洗
 - 直槽设计易将灰尘排出摩擦面
 - 安装和替换简易
 - 适合轻量化设计
-
- Maintenance free plastic linear bearing. Low noise operation is suitable for continuously application under the extremely dusty environment. It is washable by the clean detergent of the food machine. There is no critical requirement about the shaft hardness or the mounting holes of the housing
 - Maintenance-free, dry operation, low noise
 - Suitable for long-time running in dusty environments
 - Corrosion resistance; Cleaning with disinfectant lotion
 - Straight grooves design removed the dust from the friction surface
 - Easy installation and replacement
 - Suitable for lightweight design

CSB-LIN[®]直线轴承高承载能力

CSB-LIN[®] linear bearings with high loading capability

CSB-LIN[®]塑料直线轴承作为一种直线滑动轴承，工作面是以面形式与轴表面接触，而传动的滚珠直线轴承是以点线的形式和轴表面接触；这就决定了较大接触面的LIN塑料直线轴承具有比滚珠直线轴承更高的承载能力。

As a linear sliding bearings, the contacting of the bearing and the shaft is a surface instead of point contact of the traditional ball bearings. So it results in that the surface contacting CSB-LIN[®] plastic linear bearings are with better loading capability than the sliding ball bearings.

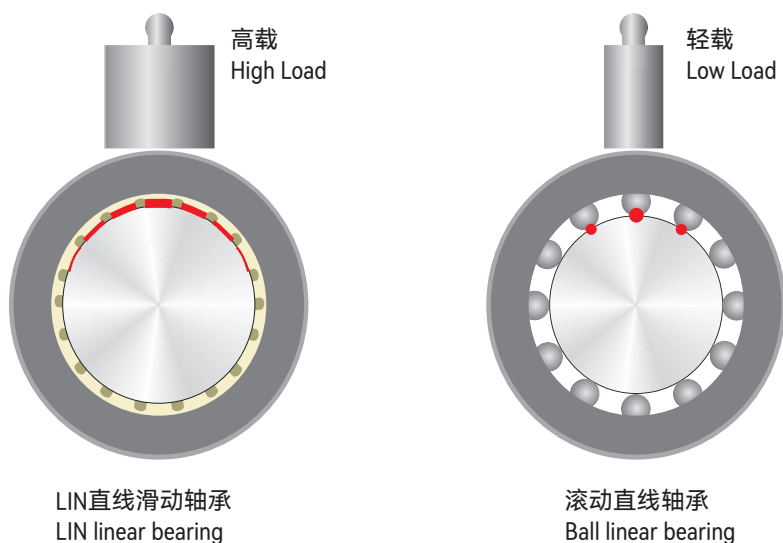

LIN 直线滑动轴承
LIN linear bearing

滚动直线轴承
Ball linear bearing

*请扫描二维码登录我们的网站查询 Please scan the QR code to log in to our website: www.csb-ep.com

CSB-LIN®直线轴承在污垢、灰尘中干运行

CSB-LIN® linear bearings used in extremely conditions of sands and dusts



CSB-LIN®直线轴承滑动膜是由高耐磨标准材料EPB13制成；特殊的直槽结构设计允许轴承在污垢、灰尘或沙粒中平稳运行，直槽能使得脏物很快速的落入到设计的凹槽中，并通过不断的直线运动最终被从凹槽中带出直线轴承系统。而传统的金属滚动直线轴承在有污垢、灰尘或沙粒存在的情况下会很容易出现卡死、跑珠等现象而卡死，甚至会因卡死现象导致轴被拉伤。

CSB-LIN® liners is made from high anti-wear material EPB13. The straight grooves design allows the bearing to be used in the extremely conditions such as in sands and dusts. The straight grooves design allows the sands or dusts entering the grooves and be brought out of the bearing system finally ,but the traditional ball bearings will be blocked by the entered sands or dusts, then the ball bearings moving system and the shaft surface will be damaged.

CSB-LIN®直线轴承低噪音运行

CSB-LIN® linear bearings operation with low noise

金属滚珠直线轴承由于滚珠在运动过程中与保持架体之间的撞击所发出的噪音，而且这种噪音会随着速度的加快而增高。但CSB-LIN®直线轴承的工作面为滑动摩擦设计，所以在运行过程中只能发出较低的摩擦声，运行噪音非常低。

Metal ball bearings generates high noise by the crashing of balls to the shafts during the operation and the noise will be sharply increased when the operation speed goes higher while the CSB-LIN® plastic linear bearings are with the surface contacting structure which ensures a lower operation noise level.

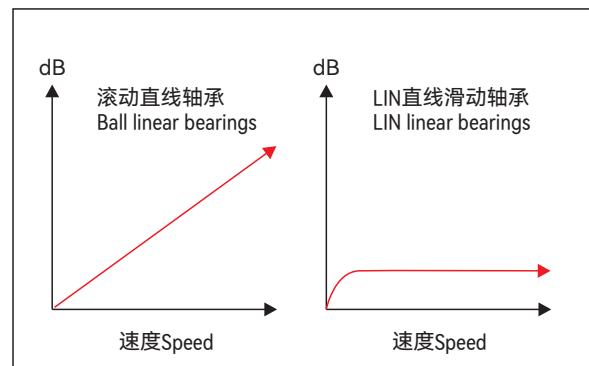

■ 噪音曲线对比图 Comparison of noise development

CSB-LIN®直线轴承允许经常接触清洗液

CSB-LIN® linear bearings allows the access of cleaning solution

CSB-LIN®直线轴承被经常用于食品包装机械的导向机构中，经常受到清洗液的冲刷；多年的使用证明CSB-LIN®直线轴承正如所设计的那样足够抵抗各类碱性清洗液的腐蚀，甚至能整体浸泡在液体介质中运行。

The CSB-LIN® plastic linear bearings are used in the food packing machine guiding system so it is easily access to the cleaning solutions. Years of application experience proves that the CSB-LIN® plastic linear bearings are corrosion resistant to most kinds of Alkaline cleaning solutions or could be even immersed into the solutions.

CSB-LIN[®] Plastic Linear Bearings

CSB-LIN[®] 塑料直线轴承

滑动膜技术数据表 Liners technical data table

材料性能 Material properties	测试标准 Standard	单位 Unit	CSB-EPB13	CSB-EPB5	CSB-MN2
颜色 Color	-	-	黄色 Yellow	黑色 Black	深灰 Dark grey
密度 Density	ISO1183	g/cm ³	1.48	1.44	1.65
最大吸湿率 Max. moisture absorption, 50%RH	ISO62	%	0.3	0.1	0.2
最大吸水率 Max. water absorption	ISO62	%	1.3	0.5	0.7
对钢动摩擦系数 Coefficient of sliding friction(steel)	ITS025	μ	0.05-0.15	0.09-0.25	0.10-0.18
极限PV值 Max. PV value	ITS026	N/mm ² ×m/s	0.40	1.40	0.30
弯曲模量 Flexural modulus	ISO178	MPa	2600	4800	2400
弯曲强度 Flexural strength	ISO178	MPa	60	165	53
最大静载荷 Max. static load	ITS027	MPa	35	110	30
最大动载荷 Max. dynamic load	ITS028	MPa	14	61	12
邵氏硬度 Shore hardness	ISO868	D	74	82	73
连续运行温度 Long-term application temperature	ITS029	°C	+90	+250	+90
短时运行温度 Short-term application temperature	ITS029	°C	+120	+315	+120
最低运行温度 Lowest application temperature	ITS029	°C	-50	-100	-50
导热性 Thermal conductivity	ISO22007	W/m/K	0.25	0.55	0.24
线性热膨胀系数 Coefficient of thermal expansion	ISO11359	K ⁻¹ ×10 ⁻⁵	10	6	8
阻燃等级 Flammability	UL94	Class	HB	V0	HB
体电阻率 Volume resistance	IEC60093	Ω·cm	>10 ¹³	>10 ⁸	>10 ⁸
面电阻率 Surface resistance	IEC60093	Ω	>10 ¹²	>10 ⁷	>10 ⁸

*ITS: CSB内部测试标准 CSB company's internal test standards.

**除非特殊说明测试温度为23°C Test temperatures are 23°C unless otherwise stated.

CSB-LIN[®] 直线轴承承载能力 Load capacity

■ 滑动膜材料: CSB-EPB13
Liner material: CSB-EPB13

内径 Inner diameter	最大许可动载荷 [N] Dynamic Load P=5MPa		最大许可静载荷 [N] Max. Static Load P=35MPa	
	LIN-11 滑动膜 LIN-11 Liners	LIN-12 滑动膜 LIN-12 Liners	LIN-11 滑动膜 LIN-11 Liners	LIN-12 滑动膜 LIN-12 Liners
10	870	780	6090	5460
12	1152	1008	8064	7056
16	1728	1440	12096	10080
20	2700	1800	18900	12600
25	4350	3000	30650	21000
30	6120	4500	42840	31500
40	9600	7200	67200	50400
50	15000	10500	105000	73500



LIN-11
[Ø10mm-Ø50mm]



LIN-12
[Ø10mm-Ø50mm]



LIN-11K
[Ø10mm-Ø50mm]



LIN-00
[Ø6mm-Ø30mm]



LIN-01
[Ø6mm-Ø30mm]



LIN-01-MR4
[Ø6mm-Ø30mm]



LIN-02
[Ø6mm-Ø30mm]



ELB
[Ø6mm-Ø30mm]



LIN-11R
[Ø6mm-Ø50mm]



LIN-12R
[Ø6mm-Ø50mm]



LIN-12RL
[Ø10mm-Ø30mm]



LIN-11RK
[Ø10mm-Ø50mm]



LIN-11RS
[Ø10mm-Ø50mm]



LIN-11RSK
[Ø10mm-Ø50mm]



LIN-11RF
[Ø6mm-Ø50mm]



LIN-11RT
[Ø6mm-Ø50mm]

*请扫描二维码登录我们的网站查询 Please scan the QR code to log in to our website: www.csb-ep.com

CSB-LIN[®] Plastic Linear Bearings

CSB-LIN[®] 塑料直线轴承



LIN-12RFL
[Ø10mm-Ø50mm]



LIN-12RTL
[Ø10mm-Ø50mm]



LIN-12RFM
[Ø10mm-Ø50mm]



LIN-12RTM
[Ø10mm-Ø50mm]



LIN-11B
[Ø12mm-Ø50mm]



LIN-11BH
[Ø10mm-Ø30mm]



LIN-11BK
[Ø12mm-Ø50mm]



LIN-11BKE
[Ø12mm-Ø50mm]



LIN-12B
[Ø12mm-Ø50mm]



LIN-12BE
[Ø12mm-Ø50mm]



LIN-11BF
[Ø12mm-Ø50mm]



LIN-11BFK
[Ø12mm-Ø50mm]



LIN-12BL
[Ø12mm-Ø50mm]



LIN-12BHL
[Ø10mm-Ø30mm]



LIN-12BLP
[Ø12mm-Ø30mm]



LIN-01G
[Ø12mm-Ø30mm]

*请扫描二维码登录我们的网站查询 Please scan the QR code to log in to our website: www.csb-ep.com

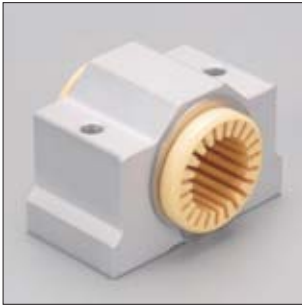

LIN-01GN
[Ø12mm-Ø30mm]



LIN-11G
[Ø12mm-Ø50mm]

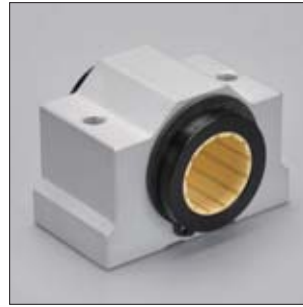

LIN-11GN
[Ø12mm-Ø50mm]



LIN-11GL
[Ø12mm-Ø50mm]



LIN-11GK
[Ø12mm-Ø30mm]



LIN-11GKL
[Ø16mm-Ø30mm]

CSB-LIN[®] Plastic Linear Bearings

CSB-LIN[®] 塑料直线轴承

方轴直线导向系统 Square Linear Guides



产品特性 Product features

- CSB-LIN[®] Q 方形直线导向系统确保线性、抗扭转运动，非常适用于架空的应用。由于表面硬质氧化铝合金方轨采用空心设计，中间可穿置并保护电缆。配合 LIN-12Q 塑料直线轴承实现免维护和灵活的安装。
 - 自润滑，高耐磨
 - 低噪音、易安装
 - 用于抗扭转直线运动
 - 适用于污垢或灰尘环境
- CSB-LIN[®] square linear guide system ensures linear, torque-resistant motion are ideally suited for the unsupported applications. Due to the hollow design of the surface hard anodized aluminum alloy square rail, the cables can be inserted and protected in hollow profile. and installed with LIN-12Q plastic linear bearing will be maintenance-free and flexible installation.
 - Maintenance-free, high wear resistance
 - Low noise and fitted very easy
 - Linear movement with torque resistance
 - Resistance to dirt and dust



QAS / QAS-EC01
[尺寸Size: 20mm]



LIN-12Q
[内孔尺寸Inner dimension: 20mm]



LIN-12QRF
[内孔尺寸Inner dimension: 20mm]



LIN-12QRF
[内孔尺寸Inner dimension: 20mm]



LIN-12QRT
[内孔尺寸Inner dimension: 20mm]



LIN-12QRTL
[内孔尺寸Inner dimension: 20mm]



LIN-12QB
[内孔尺寸Inner dimension: 20mm]



LIN-12QBL
[内孔尺寸Inner dimension: 20mm]

*请扫描二维码登录我们的网站查询 Please scan the QR code to log in to our website: www.csb-ep.com

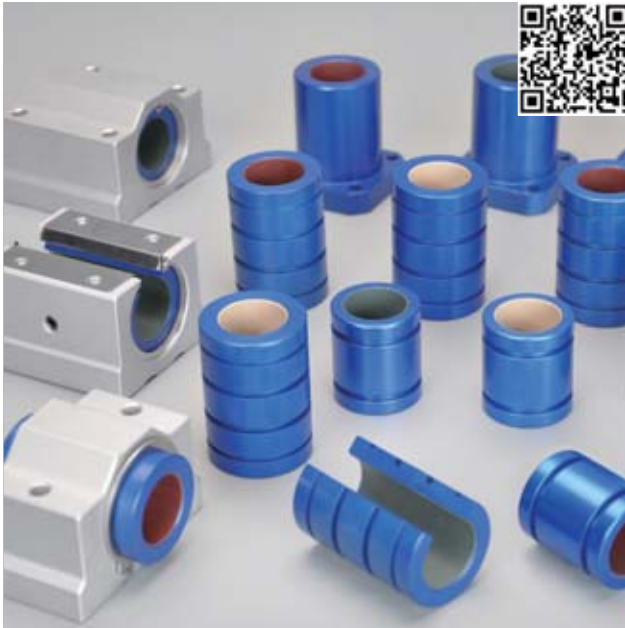

产品特性 Product features

- LINP精密直线轴承与金属滚珠直线轴承尺寸精度保持一致，但具有更高的承载能力且运行噪音极低。滑动膜采用了TEFPLAS[™]复合材料实现长期免维护，低摩擦系数，适用于高低温±200°C运行；TEFPLAS[™]材料结合LINP小间隙运行不但对轴不会造成损伤而且能清洁轴表面污垢。
- 自润滑，免维护
- 高精度，运行平稳
- 减振，无噪音
- 高速运行，长寿命
- 适合直线、旋转和摇摆运动
- LINP precision linear bearings have the same dimensional accuracy as metal ball linear bearings, but with higher load carrying capacity and extremely low operating noise. The liners are made of TEFPLAS[™] compounds developed for maintenance-free and low friction coefficient, LINP linear bearings suitable for ± 200 °C operation temperature; LINP small gap operation with TEFPLAS[™] materials will not damage to the shaft and can clean the surface dirt.
- Self-lubricating, maintenance-free
- High precision and smooth operation
- Vibration reduction, no noise
- High-speed operation and long life
- Suitable for linear, rotary and swing motion

LINP滑动膜材料 Liner materials

TEFPLAS[™] B 是LINP精密直线轴承标准滑动膜材料，综合高承载与耐磨特性，适用于硬度HRC35以上硬轴。

TEFPLAS[™] G 极好的耐磨性能，适用于硬轴、不锈钢轴或铝轴。

TEFPLAS[™] E 符合FDA食品接触安全材料，适用于不锈钢轴或铝轴。

TEFPLAS[™] B is a standard liner material for LINP precision linear bearings. It combines high load bearing and wear resistance performance, suitable for hard shaft HRC35 or higher.

TEFPLAS[™] G has excellent wear resistance, suitable for hard shaft, stainless steel shaft or aluminum shaft.

TEFPLAS[™] E FDA food contact safety materials, suitable for stainless steel shaft or aluminum shaft.

材料 Material	摩擦系数 Dry friction coefficient	最大静载荷 Max. static load MPa	最大动载荷 Max. dynamic load MPa	极限PV值 Max. PV N/mm ² x m/s	最高干运行速度 (m/s) Max. Speed ,Dry running		运行温度* Operation temperature °C
					连续运行 Continuous	间断运行 Intermittent	
TEFPLAS [™] B	0.10-0.25	20	10	0.7	1.5	4.0	±200
TEFPLAS [™] G	0.10-0.20	16	8	0.6	1.0	3.0	±200
TEFPLAS [™] E	0.05-0.18	12	6	0.4	1.0	2.0	±200

*极端高温下运行需要考虑加大配合间隙消除轴与轴承高温膨胀引起的卡滞现象，请与CSB销售工程师联系

*For operation under extreme high temperature, it is necessary to consider increasing the fitting clearance to avoid stagnation caused by the high temperature expansion of the shaft and bearing. Please contact CSB sales engineers

*请扫描二维码登录我们的网站查询 Please scan the QR code to log in to our website: www.csb-ep.com

CSB-LIN[®]P Precision Linear Bearings

CSB-LIN[®]P 精密直线轴承

耐化学性 Chemical resistance

TEFPLAS[™] 材料可在恶劣环境下使用，即使浸没在液体中也能表现出出色的性能。TEFPLAS[™] B材料中的填充物可能会受到去离子水和其它高强度化学物质腐蚀；TEFPLAS[™] G与TEFPLAS[™] B材料几乎对所有化学物质呈现惰性。

CSB-LIN[®] P 精密直线轴承标准壳体材料阳极氧化铝，较好的化学抗性适合大部分工业应用，同时可选配316不锈钢壳体适用于具有强腐蚀化学液体环境。

TEFPLAS[™] materials stand up to harsh environments and provide excellent performance in a submerged condition. TEFPLAS[™] B : the fillers in the material can be attacked by deionized water and other harsh chemicals.

TEFPLAS[™] G and TEFPLAS[™] E : almost universal chemical inertness.

The standard shell material is anodized aluminum of CSB-LIN[®] P precision linear bearings: good chemical resistance in most industrial applications, 316 stainless steel shell are available for corrosion resistance in harsh environments

寿命影响因素 Factors affecting wear rate and life

轴的表面粗糙度、硬度以及尺寸精度都会影响CSB-LIN[®] P 精密直线轴承的寿命

更佳配合轴：

- 轴直径公差等级h6-h7，适用于所有TEFPLAS[™] 材料
- 表面粗糙度Ra0.2-0.4，适用于所有TEFPLAS[™] 材料
- 表面硬度HRC50，根据不同TEFPLAS[™] 材料可配合软轴

Affecting the life of CSB-LIN[®] P precision linear bearings: surface roughness, hardness and dimensional accuracy of the shaft

Recommend shafts for the best performance:

- Shaft diameter tolerance h6-h7, suitable for all TEFPLAS[™] materials
- Surface roughness Ra0.2-0.4, suitable for all TEFPLAS[™] materials
- Surface hardness HRC50, according to different TEFPLAS[™] materials and the soft shafts are available

偏心力 Eccentric forces

- 最大比例为2:1
- 1x = 同轴轴承距离
- 2x = 从轴到负载或驱动力的距离
- Maximum 2:1 ratio
- 1x = bearing separation on same shaft
- 2x = distance from shaft to load or force

小心：超过2:1比例时会发生爬行甚至卡死的现象！

CAUTION: uneven motion or even system blockage will occur if the 2:1 ratio is exceeded !

这个原则与负载无关！这不是由于边缘加载。它也不依赖于使用的驱动力！驱动力与轴承的距离越远，所需驱动力越大，磨损也越大。

可能还有其他因素会增加制动效果，但摩擦系数是主要原因。

注意：2:1法则是基于理论静摩擦系数0.25，然而，额外的润滑有助于降低摩擦并延长2:1的比例。

如果您有任何设计或安装方面的疑惑，请与我们的工程师联系。

This principle is NOT load dependent! It is NOT due to edge loading. It is also NOT dependent on the driving force used! The greater the distance between the drive and guide bearings, the higher the degree of wear and required drive force.

There may be other factors that add to the braking effect, but the coefficient of friction is the main cause.

NOTE: The Rule(2:1) is based on the static friction value of 0.25 theoretically, However, Additional lubrication can help to drop friction and extend the 2:1 ratio.

If you have any questions on design and/or assembly, please contact our application engineers.

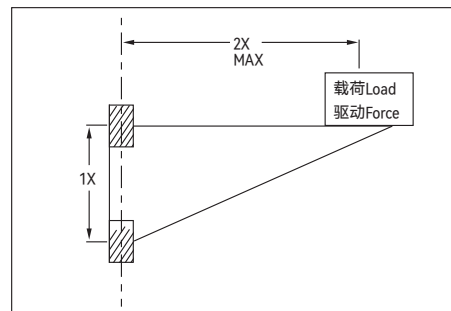

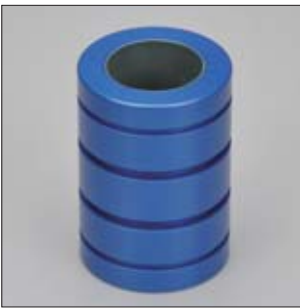

LINP-11R
[Ø8mm-Ø50mm]

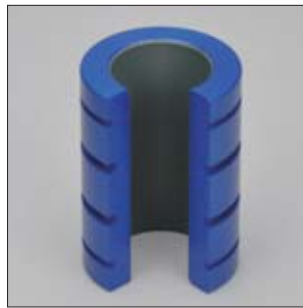

LINP-11RK
[Ø8mm-Ø50mm]

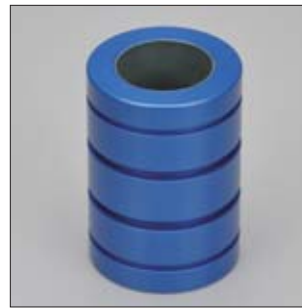

LINP-11RS
[Ø8mm-Ø50mm]

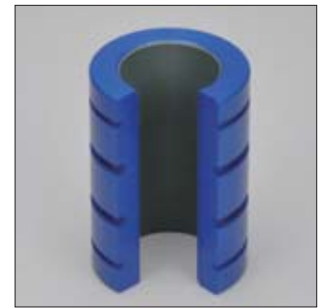

LINP-11RSK
[Ø8mm-Ø50mm]



LINP-12R
[Ø8mm-Ø50mm]

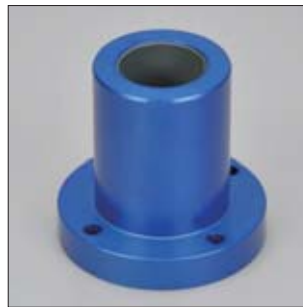

LINP-11RF
[Ø8mm-Ø50mm]

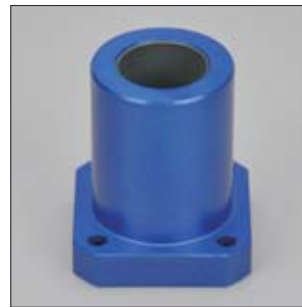

LINP-11RT
[Ø8mm-Ø50mm]



LINP-11G
[Ø12mm-Ø50mm]

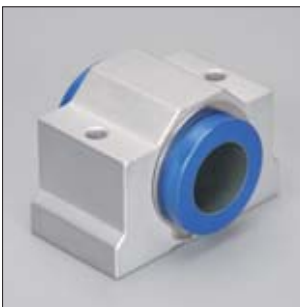

LINP-11GN
[Ø12mm-Ø50mm]



LINP-11GK
[Ø12mm-Ø50mm]



LINP-11R-IN
[Ø3/8Inch size-Ø2-1/2Inch size]

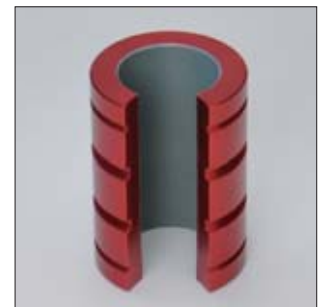

LINP-11RK-IN
[Ø3/8Inch size-Ø2-1/2Inch size]



LINP-11RS-IN
[Ø1/4Inch size-Ø1-1/2Inch size]

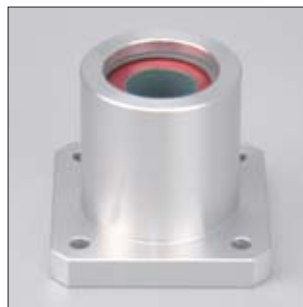

LINP-11RT-IN
[Ø3/8Inch size-Ø1-1/4Inch size]

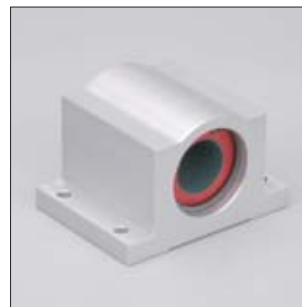

LINP-11G-IN
[Ø1/4Inch size-Ø1-1/2Inch size]



LINP-11GK-IN
[Ø1/2Inch size-Ø1-1/2Inch size]

*请扫描二维码登录我们的网站查询 Please scan the QR code to log in to our website: www.csb-ep.com

CSB-SRB® Slewing Ring Bearings

CSB-SRB® 回转支撑轴承

SRB-01 高速型回转支撑轴承 High speed slewing ring bearings



● 内径 Inner diameters: Ø20mm-Ø100mm

产品特性 Product features

- 自润滑, 免维护
- 运行平稳, 无噪音
- 高速运行, 长寿命
- 标准滑动材料TEFPLAS™ G
可选符合FDA标准材料TEFPLAS™ E
- 转盘材料硬质氧化铝合金, 可选不锈钢
- 工作温度: ±200°C
- Self-lubricating, maintenance-free
- Smooth operation, no noise
- High-speed operation and long life
- Standard material of sliding layer: TEFPLAS™ G
Available FDA grade material: TEFPLAS™ E
- Disc made of anodized aluminum, available stainless steel
- Operation temperature ±200°C

SRB-02 高载型回转支撑轴承 High load slewing ring bearings



● 内径 Inner diameters: Ø20mm-Ø100mm

产品特性 Product features

- 滑动单元均采用高载低摩擦材料CSB-11
- 内外环均采用优质碳钢表面镀铬处理
- 极高载荷和扭矩
- 工作温度: -196°C/+260°C
- 易安装、免维护
- The sliding element is a standard CSB-11 bearing with high load and low friction factor
- Inside and outside of the bearing are made with carbon steel and with chrome hard coated
- The part is with extremely high load capacity and torque
- Working temperature -196°C/+260°C
- Easy installation and maintenance free

SRB-03 回转支撑轴承 Slewing ring bearings



● 内径 Inner diameters: Ø20mm-Ø100mm

产品特性 Product features

- 自润滑、免维护
- 滑动原件采用高耐磨材料EPB13制成
- 回转环表面硬化处理
- 工作温度: -50°C/+90°C
- 可选铝合金或不锈钢304材料
- Maintenance-free, self lubricating
- Sliding elements made of high wear resistance EPB13
- Slewing ring with high stiffening
- Working temperature -50°C/+90°C
- Available as aluminum or stainless steel version 304

*请扫描二维码登录我们的网站查询 Please scan the QR code to log in to our website: www.csb-ep.com

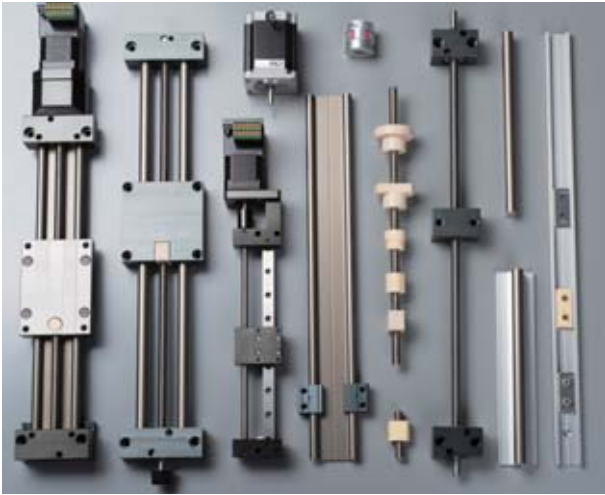

产品特性 Product features

- CSB-LMS[®]直线驱动系统均是采用免维护的滑动结构设计，所有滑动单元均采用经过耐磨优化的CSB-EPB[®]材料制成，而所有的轴或导轨均采用表面硬化处理的铝合金或不锈钢制成。合理的材料和结构设计实现了CSB-LMS[®]直线驱动系统长期免维护、耐灰尘、抗腐蚀和低噪音。
- CSB-LMS[®] linear motion system is designed with a maintenance-free sliding structure. All sliding units are made of wear-resistant material CSB-EPB[®]. All shafts or rails are Made of anodized aluminum alloy or stainless steel. Duo to the reasonable design of the material and structure, CSB-LMS[®] linear motion system is maintenance-free, resistant to dust, anti-corrosion and low noise.

精密轴 Precision shafts



● 直径 Diameters: Ø6mm-Ø50mm

AS 精密铝轴 Precision aluminum shafts

- EPB13材料制成的直线轴承更佳配合轴材料
- 材料: EN AW 6061/6060
- 直线度: EN 754-3
- 硬度: 75 HB
- 表面: 硬质氧化
- 表面硬度: 450-550 HV
- The recommended shaft material for all linear plain bearings made of EPB13
- Material: EN AW 6061/6060
- Straightness: EN 754-3
- Hardness: 75 HB
- Surface: hard anodized
- Surface hardness: 450-550 HV



● 直径 Diameters: Ø6mm-Ø30mm

CS 精密钢轴 Precision steel shafts

- 高性价比轴材料
- 可配合铝支撑底座
- 45钢, 表面镀铬
- 硬度: 60 HRC
- Cost-effective steel shafts
- Also completely supported and assembled with standard aluminium support
- C45 steel, hard-chromed
- Hardness: 60 HRC



● 直径 Diameters: Ø6mm-Ø30mm

ES 精密不锈钢轴 Precision stainless steel shafts

- 高耐腐蚀
- 可配合铝支撑底座
- 适用于潮湿场合
- 304不锈钢, 硬化
- High corrosion-resistance
- Also completely supported and assembled with standard aluminium support
- Ideal solution for the wet area
- 304 Stainless steel, hardened

*请扫描二维码登录我们的网站查询 Please scan the QR code to log in to our website: www.csb-ep.com

CSB-LMS[®] Linear Motion Systems

CSB-LMS[®] 直线驱动系统

SH 轴端支撑座
Shaft end blocks



● 直径 Diameters: Ø10mm-Ø50mm

SHF 轴端支撑座
Shaft end blocks



● 直径 Diameters: Ø10mm-Ø50mm

WAF 轴端支撑座
Shaft end blocks



● 直径 Diameters: Ø12mm-Ø50mm

WA 轴端支撑座
Shaft end blocks



● 直径 Diameters: Ø8mm-Ø50mm

WAC 轴端支撑座
Shaft end blocks



● 直径 Diameters: Ø6mm-Ø50mm

SAN 轴端支撑座
Shaft end blocks



● 直径 Diameters: Ø8mm-Ø30mm

SARF 轴端支撑座
Shaft end blocks



● 直径 Diameters: Ø8mm-Ø50mm

SAQF 轴端支撑座
Shaft end blocks

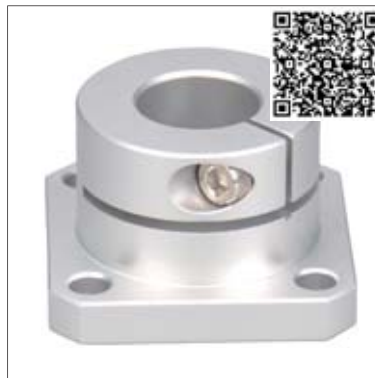

● 直径 Diameters: Ø8mm-Ø50mm

SANF 轴端支撑座
Shaft end blocks



● 直径 Diameters: Ø8mm-Ø50mm

*请扫描二维码登录我们的网站查询 Please scan the QR code to log in to our website: www.csb-ep.com

微型窄支撑轴 Small supported shafts

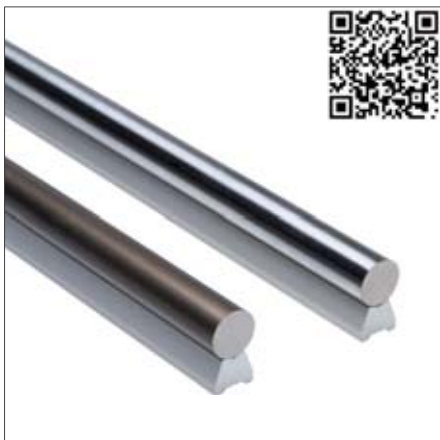

产品特性 Product features

- 窄矮型设计铝支撑
- 交货范围不包括安装螺丝
- 可用轴材料：AS精密铝轴，CS精密硬铬钢轴，ES精密304不锈钢轴
- 轴和支撑件未组装
- 最大许可长度2000mm
- Completely supported with aluminum low support
- Scope of delivery doesn't include mounting screws
- Available shaft materials: Aluminum, hard anodized, C45, hard-chromed, Stainless steel (304), hardened
- Shafts and supports are supplied unassembled
- The long of supports max. 2000 mm

● 直径 Diameters: Ø12mm-Ø30mm

标准支撑轴 Standard supported shafts

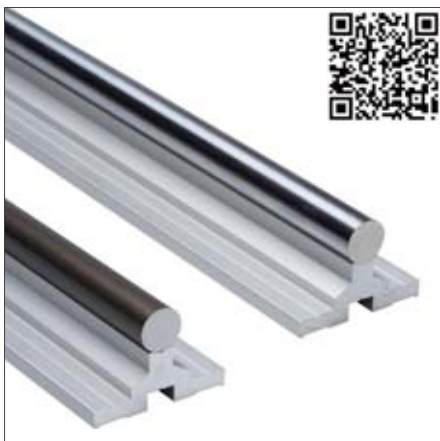

产品特性 Product features

- 标准设计支撑轴
- 可用轴材料：AS精密铝轴，CS精密硬铬钢轴，ES精密304不锈钢轴
- 轴和支撑件组装
- 最大许可长度2500mm
- Standard support shafts
- Available shaft materials: Aluminum, hard anodized, C45, hard-chromed, Stainless steel (304), hardened
- Shafts and supports are supplied assembled
- The long of supports max. 2500 mm

● 直径 Diameters: Ø12mm-Ø30mm

WR01单圆直线导轨 Linear guides, single round rail



产品特性 Product features

- 铝合金制成的导轨，硬质氧化滑动表面
- 免维护的线性滑动导轨提供几乎无限的设计自由度
- 免润滑、抗污
- 重量轻和静音
- 安装简单，免维护
- 通过干摩擦消除对污物的敏感性
- 自由设计安装宽度
- Aluminum alloy material, Hard anodized surface of sliding
- Maintenance-free linear slide guides providing virtually limitless design freedom
- Lubrication-free and dirt-resistant
- Weight saving and silent
- Simple installation, maintenance-free
- Insensitivity to dirt through dry operation
- Variable width can be fitted

● 直径 Diameters: Ø10mm, Ø16mm, Ø20mm

*请扫描二维码登录我们的网站查询 Please scan the QR code to log in to our website: www.csb-ep.com

CSB-LMS[®] Linear Motion Systems

CSB-LMS[®] 直线驱动系统

WR01单圆不锈钢直线导轨 Stainless steel linear guides, single round rail



● 直径 Diameters: $\varnothing 10\text{mm}$, $\varnothing 16\text{mm}$, $\varnothing 20\text{mm}$

产品特性 Product features

- 316Ti不锈钢单圆导轨
- 较强的抗腐蚀能力
- 配合LIN滑动膜抵抗污物
- 免维护与无噪音运行
- 自由设计安装宽度
- Single guide rails made of stainless steel 316Ti
- Good corrosion resistance
- Resistance to dirt with LIN liners
- Maintenance-free and no noise
- Variable width can be fitted

WR02双圆直线导轨 Linear guides, double round rail



● 直径 Diameters: $\varnothing 10\text{mm}$, $\varnothing 16\text{mm}$, $\varnothing 20\text{mm}$

产品特性 Product features

- 铝合金制成的导轨，硬质氧化滑动表面
- 免维护的线性滑动导轨提供几乎无限的设计自由度
- 免润滑、抗污
- 重量轻和静音
- 安装简单，免维护
- 通过干摩擦消除对污物的敏感性
- 标准安装宽度
- Aluminum alloy material, Hard anodized surface of sliding
- Maintenance-free linear slide guides providing virtually limitless design freedom
- Lubrication-free and dirt-resistant
- Weight saving and silent
- Simple installation, maintenance-free
- Insensitivity to dirt through dry operation
- Standard fitting width

WR02双圆不锈钢直线导轨 Stainless steel linear guides, double round rail



● 直径 Diameters: $\varnothing 10\text{mm}$, $\varnothing 16\text{mm}$, $\varnothing 20\text{mm}$

产品特性 Product features

- 316Ti不锈钢双圆导轨
- 较强的抗腐蚀能力
- 配合LIN滑动膜抵抗污物
- 免维护与无噪音运行
- 标准安装宽度
- Dual guide rails made of stainless steel 316Ti
- Good corrosion resistance
- Resistance to dirt with LIN liners
- Maintenance-free and no noise
- Standard fitting width

*请扫描二维码登录我们的网站查询 Please scan the QR code to log in to our website: www.csb-ep.com

WRU01不锈钢导轨滑块 Stainless steel guide rail sliding blocks

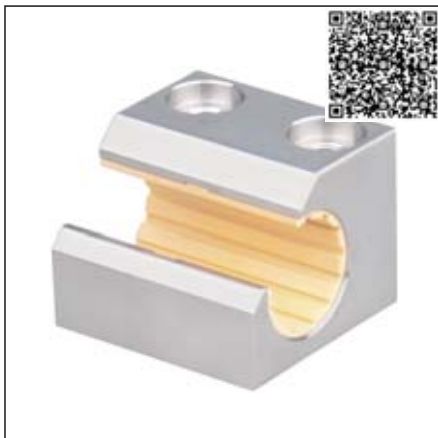

● 直径 Diameters: Ø10mm, Ø16mm, Ø20mm

产品特性 Product features

- 安装标准滑动膜EPB13
- 316Ti不锈钢轴承座
- 抗腐蚀能力强
- 自润滑、免维护
- 抵抗灰尘，无噪音运行
- 可用于WR不锈钢单轨和双轨
- Fitted standard liners EPB13
- Housing made of stainless steel 316Ti
- Good corrosion resistance
- Self-lubricating and maintenance-free
- Resistant dust and no noise
- For WR ES single and dual guide rails

WRU01圆导轨滑块 Round rail sliding blocks

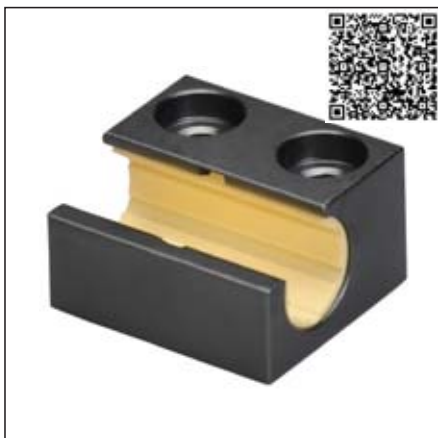

● 直径 Diameters: Ø10mm, Ø16mm, Ø20mm

产品特性 Product features

- 安装标准滑动膜EPB13
- 自润滑、免维护
- 重量轻、快速装配
- 可用于WR系列单轨和双轨
- 抵抗灰尘
- 无噪音运行
- Fitted standard liners EPB13
- Maintenance-free, dry-running
- Fast assembly and light weight
- For WR single and dual guide rails
- Resistant Dust and silent
- Silent operation

WRU01圆导轨滑块 Round rail sliding blocks

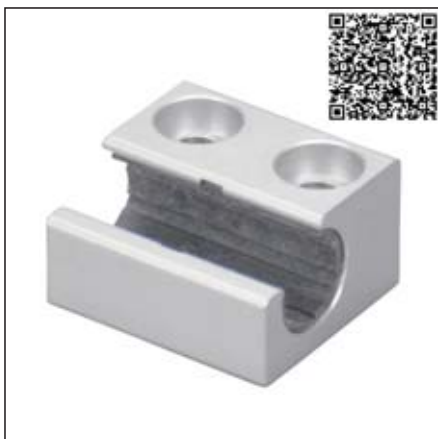

● 直径 Diameters: Ø10mm, Ø16mm, Ø20mm

产品特性 Product features

- 安装铝轴滑动膜MN2
- 自润滑、免维护
- 重量轻、快速装配
- 可用于WR系列单轨和双轨
- 抵抗灰尘
- 无噪音运行
- Fitted MN2 liners for aluminum shafts
- Maintenance-free, dry-running
- Fast assembly and light weight
- For WR single and dual guide rails
- Resistant Dust and silent
- Silent operation

*请扫描二维码登录我们的网站查询 Please scan the QR code to log in to our website: www.csb-ep.com

CSB-LMS[®] Linear Motion Systems

CSB-LMS[®] 直线驱动系统

WRU01多用型圆导轨滑块 Round rail sliding blocks(High-performance)



● 直径 Diameters: Ø10mm, Ø16mm, Ø20mm

产品特性 Product features

- 耐磨层材料TEFPLAS[®] B
- 使用温度±200°C
- 最高连续速度1.5m/s
- 重量轻、快速装配
- 可用于WR系列单轨和双轨
- 无噪音运行
- Wear layer material: TEFPLAS[®] B
- Operation temperature ±200°C
- Max. continuous running speed 1.5m/s
- Fast assembly and light weight
- For WR single and dual guide rails
- Silent operation

WRU01加长型圆导轨滑块 Round rail sliding blocks(long design)



● 直径 Diameters: Ø10mm, Ø16mm, Ø20mm

产品特性 Product features

- 安装2个标准滑动膜EPB13, 可选铝轴滑动膜MN2
- 承载能力是标准型的2倍
- 自润滑、免维护
- 重量轻、快速装配
- 可用于WR系列单轨和双轨
- 抵抗灰尘
- 无噪音运行
- Assembled 2pcs standard liners EPB13, MN2 liners for aluminum shafts
- Carrying capacity is twice that of the standard type
- Maintenance-free, dry-running
- Fast assembly and light weight
- For WR single and dual guide rails
- Resistant dust
- Silent operation

WRU02圆导轨混合滑块 Round rail hybrid blocks



● 直径 Diameters: Ø10mm, Ø16mm, Ø20mm

产品特性 Product features

- 标准滚动与滑动混合滑块
- 顺畅运动且驱动力比标准型下降45%
- 导向滑动膜标准材料EPB13
- 抵抗灰尘与无噪音运行
- 可用于WR系列单轨和双轨
- 多种安装方式可选
- Rolling and sliding hybrid blocks
- Smooth moving and driving force reduced 45%
- Sliding liners material: EPB13
- Resistant dust and quiet operation
- For WR single and dual guide rails
- Various installation options are available

*请扫描二维码登录我们的网站查询 Please scan the QR code to log in to our website: www.csb-ep.com

WRU02加长型圆导轨混合滑块 Round rail hybrid blocks, long design



● 直径 Diameters: Ø10mm, Ø16mm, Ø20mm

产品特性 Product features

- 滚动与滑动混合加长设计滑块
- 顺畅运动且驱动力比标准型下降45%
- 导向滑动膜标准材料EPB13
- 承载能力是标准型的2倍
- 抵抗灰尘与无噪音运行
- 可用于WR系列单轨和双轨
- 多种安装方式可选
- Rolling and sliding hybrid blocks and long design
- Smooth moving and driving force reduced 45%
- Sliding liners material: EPB13
- Carrying capacity is twice that of the standard type
- Resistant dust and quiet operation
- For WR single and dual guide rails
- Various installation options are available

WRC01圆导轨滑台 Assembled guide carriages



● 直径 Diameters: Ø10mm, Ø16mm, Ø20mm

产品特性 Product features

- 安装标准滑动膜EPB13
- 自润滑、免维护
- 重量轻、快速装配
- 用于WR系列双轨
- 抵抗灰尘
- 无噪音运行
- Fitted standard liners EPB13
- Maintenance-free, dry-running
- Fast assembly and light weight
- For WR dual guide rails
- Resistant dust and silent
- Silent operation
- Variable length can be fitted

WRC01圆导轨滑台 Assembled guide carriages



● 直径 Diameters: Ø10mm, Ø16mm, Ø20mm

产品特性 Product features

- 铝轴滑动膜MN2
- 自润滑、免维护
- 重量轻、快速装配
- 用于WR系列双轨
- 抵抗灰尘
- 无噪音运行
- MN2 liners for aluminum shafts
- Maintenance-free, dry-running
- Fast assembly and light weight
- For WR dual guide rails
- Resistant dust and silent
- Silent operation
- Variable length can be fitted

*请扫描二维码登录我们的网站查询 Please scan the QR code to log in to our website: www.csb-ep.com

CSB-LMS[®] Linear Motion Systems

CSB-LMS[®] 直线驱动系统

WRC01圆导轨滑台 Assembled guide carriages



● 直径 Diameters: $\varnothing 10\text{mm}$, $\varnothing 16\text{mm}$, $\varnothing 20\text{mm}$

产品特性 Product features

- 耐磨层材料TEFPLAS[®] B
- 使用温度 $\pm 200^{\circ}\text{C}$
- 最高连续运行速度 1.5m/s
- 重量轻、快速装配
- 用于WR系列双轨
- 抵抗灰尘
- 无噪音运行
- Wear layer material: TEFPLAS[®] B
- Operation temperature $\pm 200^{\circ}\text{C}$
- Max. continuous running speed 1.5m/s
- Fast assembly and light weight
- For WR dual guide rails
- Resistant dust and silent
- Silent operation

WRC01圆导轨滑台 Assembled guide carriages



● 直径 Diameters: $\varnothing 10\text{mm}$, $\varnothing 16\text{mm}$, $\varnothing 20\text{mm}$

产品特性 Product features

- 标准滑动膜EPB13
- 带夹紧手轮设计
- 相机固定 3/8" 螺纹孔
- 自润滑、免维护
- 重量轻、抵抗灰尘
- Sliding liners material: EPB13
- With locking handwheel design
- 3/8" threaded hole for camera
- Self-lubricating, maintenance-free
- Lightweight and resistant to dust

WRC02圆导轨混合滑台 Assembled hybrid carriages



● 直径 Diameters: $\varnothing 10\text{mm}$, $\varnothing 16\text{mm}$, $\varnothing 20\text{mm}$

产品特性 Product features

- 滚动与滑动混合滑台
- 顺畅滑动，驱动力比标准型下降45%
- 导向滑动膜标准材料EPB13
- 配合WR02导轨侧向安装
- 自润滑、免维护
- 抗灰尘、无噪音
- Rolling and sliding hybrid carriages
- Smooth moving and driving force reduced 45% than the standard carriages
- Sliding liners material: EPB13
- For side installation of WR02 guide rails
- Maintenance-free, dry-running
- Resistant dust and no noise

*请扫描二维码登录我们的网站查询 Please scan the QR code to log in to our website: www.csb-ep.com

WRC02圆导轨混合滑台 Assembled hybrid carriages



● 直径 Diameters: Ø10mm, Ø16mm, Ø20mm

产品特性 Product features

- 滚动与滑动混合滑台
- 顺畅滑动，驱动力比标准型下降45%
- 导向滑动膜标准材料EPB13
- 配合WR02导轨水平安装
- 自润滑、免维护
- 抗灰尘、无噪音
- Rolling and sliding hybrid carriages
- Smooth moving and driving force reduced 45% than the standard carriages
- Sliding liners material: EPB13
- For horizontal installation of WR02 guide rails
- Maintenance-free, dry-running
- Resistant dust and no noise

WRC03圆导轨滑台 Assembled guide carriages



● 直径 Diameters: Ø10mm, Ø16mm, Ø20mm

产品特性 Product features

- 安装LIN-11标准滑动膜
- 自润滑、免维护
- 整体式设计、低成本
- 用于WR系列双圆轨
- 抵抗灰尘、无噪音
- Fitted LIN-11 standard liners
- Maintenance-free, dry-running
- Mono-design and low cost
- For WR double round guide rails
- Resistant dust and quiet

WQ01方型单轨 Single square guide rails



● 尺寸 Size: 06mm, 10mm, 16mm, 20mm

产品特性 Product features

- 方型铝合金单轨
- 硬质氧化滑动表面
- 免维护的线性滑动导轨
- 免润滑、抗污
- 重量轻和静音
- 自由设计安装宽度
- Square single guide rails made of aluminum
- Hard anodized the sliding surface
- Maintenance-free linear sliding guide rails
- Lubrication-free and dirt-resistant
- Light weight and quiet
- Variable width can be fitted

*请扫描二维码登录我们的网站查询 Please scan the QR code to log in to our website: www.csb-ep.com

CSB-LMS[®] Linear Motion Systems

CSB-LMS[®] 直线驱动系统

WQ02方型双轨 Double square guide rails



产品特性 Product features

- 方型铝合金双轨
- 硬质氧化滑动表面
- 免维护的线性滑动导轨
- 免润滑、抗污
- 重量轻和静音
- 标准安装宽度
- Square double guide rails made of aluminum
- Hard anodized the sliding surface
- Maintenance-free linear sliding guide rails
- Lubrication-free and dirt-resistant
- Light weight and quiet
- Standard fitting width

● 尺寸 Size: 06mm, 10mm, 16mm, 20mm

WQU01方型导轨滑块 Square guide rail blocks



产品特性 Product features

- 安装LIN-11Q方型滑动膜
- 自润滑、免维护
- 用于WQ系列方型导轨
- 抗灰尘、无噪音
- Fitted LIN-11Q square liners
- Maintenance-free, dry-running
- For WQ square guide rails
- Resistant dust and quiet

● 尺寸 Size: 06mm, 10mm, 16mm, 20mm

WQC01方型导轨滑台 Square guide rail carriages



产品特性 Product features

- 安装LIN-11Q方型滑动膜
- 自润滑、免维护
- 重量轻、快速装配
- 用于WQ系列方型双轨
- 抵抗灰尘、无噪音
- Fitted LIN-11Q square liners
- Maintenance-free, dry-running
- Fast assembly and light weight
- For WQ double square guide rails
- rails Resistant dust and quiet

● 尺寸 Size: 06mm, 10mm, 16mm, 20mm

*请扫描二维码登录我们的网站查询 Please scan the QR code to log in to our website: www.csb-ep.com

WQC02方型导轨滑台 Square guide rail carriages



● 尺寸 Size: 06mm, 10mm, 16mm, 20mm

产品特性 Product features

- 安装LIN-11Q方型滑动膜
- 自润滑、免维护
- 整体式设计、低成本
- 用于WQ系列方型双轨
- 抵抗灰尘、无噪音
- Fitted LIN-11Q square liners
- Maintenance-free, dry-running
- Mono-design and low cost
- For WQ double square guide rails
- Resistant dust and quiet

NR01微型直线导轨 Small linear guides



● 宽度 Width: 17mm, 27mm, 40mm

产品特性 Product features

- 很小安装高度6-12mm
- 轻量级
- 较多的滑块选项 - 有带预张力设计
- 免维护，自润滑
- 耐腐蚀
- 低磨损，摩擦系数低
- 银色阳极氧化处理
- Small installation height from 6 to 12 mm
- Lightweight
- Numerous carriage options - also with preload design
- Maintenance-free, self lubricating
- Corrosion-resistant
- Low wear with low coefficient of friction
- Rails in silver anodized

NRU01导轨滑块 Guide rail sliders



● 宽度 Width: 17mm, 27mm

产品特性 Product features

- 标准耐磨材料EPB13制成
- 多种选择：标准和带预紧设计
- 极小重量和无噪音运行
- 自润滑、免维护
- 配合导轨NR01-17和NR01-27
- 最大载荷为50N和500N
- Made of high anti-wear material EPB13
- Variants: Standard, Preload (P)
- extrem low weight quiet running
- Maintenance-free, self lubricating
- Installation for NR01-17 and NR01-27
- Max. load 50N and 500N

*请扫描二维码登录我们的网站查询 Please scan the QR code to log in to our website: www.csb-ep.com

CSB-LMS[®] Linear Motion Systems

CSB-LMS[®] 直线驱动系统

NRU02导轨滑块 Guide rail sliders



● 宽度 Width: 27mm, 40mm

产品特性 Product features

- 标准耐磨材料EPB13制成
- 极小重量和无噪音运行
- 自润滑、免维护
- 配合导轨NR01-27和NR01-40
- 最大载荷为500N和700N
- Made of high anti-wear material EPB13
- extrem low weight quiet running
- Maintenance-free, self lubricating
- Installation for NR01-27 and NR01-40
- Max. load 500N and 700N

NRU03导轨滑块 Guide rail sliders



● 宽度 Width: 27mm, 40mm

产品特性 Product features

- 标准耐磨材料EPB13制成
- 多种选择: 标准和带预紧设计
- 极小重量和无噪音运行
- 自润滑、免维护
- 配合导轨NR01-27和NR01-40
- 最大载荷为500N和700N
- Made of high anti-wear material EPB13
- Variants: Standard, Preload (P)
- extrem low weight quiet running
- Maintenance-free, self lubricating
- Installation for NR01-27 and NR01-40
- Max. load 500N and 700N

NCAP导轨端盖 Guide rail end caps



● 宽度 Width: 17mm, 27mm, 40mm

产品特性 Product features

- 易安装
- 低成本
- 可拆卸
- 高压紧力
- Easy installation
- Low-priced
- Dismantling possible
- High retention force

*请扫描二维码登录我们的网站查询 Please scan the QR code to log in to our website: www.csb-ep.com

HR01直线导轨 Linear guide rails



● 宽度 Width: 15mm, 20mm, 25mm

产品特性 Product features

- 很小的导轨安装宽度15-23mm
 - 安装宽度与孔距与标准滚珠导轨保持一致
 - 表面经过硬质氧化铝合金
 - 可拼接实现超长导轨设计
 - 配合HRC免维护滑台使用
 - 轻量化设计
- Small installation width from 15 to 23 mm
 - The installation width and the holes are consistent with the standard ball guide rails
 - Made of hard anodized surface of aluminum alloy
 - Available longer design by the guide rails connection
 - Maintenance-free with HRC roller carragies
 - Lightweight design

HRC01滚轮滑台 Roller carriages



● 宽度 Width: 15mm, 20mm, 25mm

产品特性 Product features

- 滚轮滑台带除尘与防撞缓冲片设计
 - 非常适合高速应用，最高速度10m/s
 - 顺畅运动，驱动力约为滑动滑台的10%
 - 安装螺纹孔与标准滚珠滑块保持一致
 - 带间隙补偿调节功能
- 多版本可选：ST-标准高耐磨，HT-高耐温，VQ-低噪音
- 最高长期使用温度：ST-90°C，HT-120°C，VQ-70°C
 - 自润滑、免维护，抗灰尘、无噪音
- With dust removal and anti-collision buffer elastic plate design
 - Very suitable for high speed applications, the speed up to 10m/s
 - Smooth moving, Driving force is about 10% of sliding carriages
 - Installation threaded holes are consistent with the standard ball sliders
 - Clearance adjustment, multi-version available: ST-standard anti-wear carriages, HT-high temperature carriages, VQ-very quiet carriages
 - Max. long-term temperature: ST-90°C, HT-120°C, VQ-70°C
 - Maintenance-free, dry-running, Resistant dust and no noise

*请扫描二维码登录我们的网站查询 Please scan the QR code to log in to our website: www.csb-ep.com

直线驱动系统
Linear Motion Systems

www.csb-ep.com
sales@csb-ep.com

电话: 0573 84186133/84185527
Tel: 0086 573 84187009

CSB-LMS[®] Linear Motion Systems

CSB-LMS[®] 直线驱动系统

LMS01直线模组 Linear modules



产品特性 Product features

- 标准设计模组
- 可选不同轴材料和丝杆
- 免维护，耐腐蚀
- 可选丝杆TR10x2, TR18x4, TR24x5
- 可在+60 °C环境中长期使用
- Standard design
- Various materials for shaft and lead screw
- Maintenance-free and optionally corrosion resistant
- TR10x2, TR18x4, TR24x5
- Temperature resistant up to +60 °C

● 最大行程 Max. stroke: 1250mm

LMS01PL直线模组 Linear modules



产品特性 Product features

- 预紧梯形丝杠螺母，预紧力：50N
- 可选不同轴材料和丝杆
- 可选丝杆TR10x2, TR18x4, TR24x5
- 手动和连续可调的径向游隙
- 免维护且重量轻
- 耐高温高达+60°C
- Preloaded trapezoidal lead screw nuts, preload force: 50 N
- Various materials for shaft and lead screw
- TR10x2, TR18x4, TR24x5
- Manually and continuously adjustable radial clearance
- Lubrication-free and lightweight
- Temperature resistant up to +60 °C

● 最大行程 Max. stroke: 1250mm

LMS02直线模组 Linear modules



产品特性 Product features

- 经紧凑型设计
- 稳定传动
- 表面硬化处理铝制WR导轨
- 可在+60 °C环境中长期使用
- Flat and compact
- High torsional stability
- Aluminium WR guide rails, hard anodized
- Temperature resistant up to +60 °C

● 最大行程 Max. stroke: 1000mm

*请扫描二维码登录我们的网站查询 Please scan the QR code to log in to our website: www.csb-ep.com

LMS02BB直线模组 Linear modules



● 最大行程 Max. stroke: 900mm

产品特性 Product features

- 较低的驱动力
- 表面硬化处理铝制WR导轨
- 降低了系统振动，噪音低
- 丝杆两端采用滚珠轴承支撑
- 多种滑块长度可选
- 可在+60 °C环境中长期使用
- Lower drive force
- Aluminum WR guide rails, hard anodized
- Quiet operation - reduced vibration of the overall system
- Ball bearings in both lead screw end supports
- Linear carriages available in different lengths
- Temperature resistant up to +60 °C

LMS03直线模组 Linear modules



● 最大行程 Max. stroke: 3000mm

产品特性 Product features

- 轻载快速定位
- 紧凑型无噪音设计
- 驱动轴单边或双边设计
- 多种滑块长度可选
- 可在+60 °C环境中长期使用
- Fast positioning of small loads
- Quiet operation and flat design
- Drive shaft on one or both sides
- Linear carriages available in different lengths
- Temperature resistant up to +60 °C

LMS04直线模组 Linear modules



产品特性 Product features

- 薄型设计，采用梯形丝杆和导轨平行安装
- 自润滑，高效能，重量轻
- 可自由设计间距和长度
- 可选右旋或左旋丝杆
- 可在+60 °C环境中长期使用
- Low profile structure through lateral lead screw arrangement
- Lubrication-free, high efficiency, lightweight
- Variable pitch and length
- Lead screw arrangement can be selected either left or right
- Temperature resistant up to +60 °C

*请扫描二维码登录我们的网站查询 Please scan the QR code to log in to our website: www.csb-ep.com

直线驱动系统
Linear Motion Systems

www.csb-ep.com
sales@csb-ep.com

电话: 0573 84186133/84185527
Tel: 0086 573 84187009

CSB-LMS[®] Linear Motion Systems

CSB-LMS[®] 直线驱动系统

LMS01-E直线模组 Linear modules

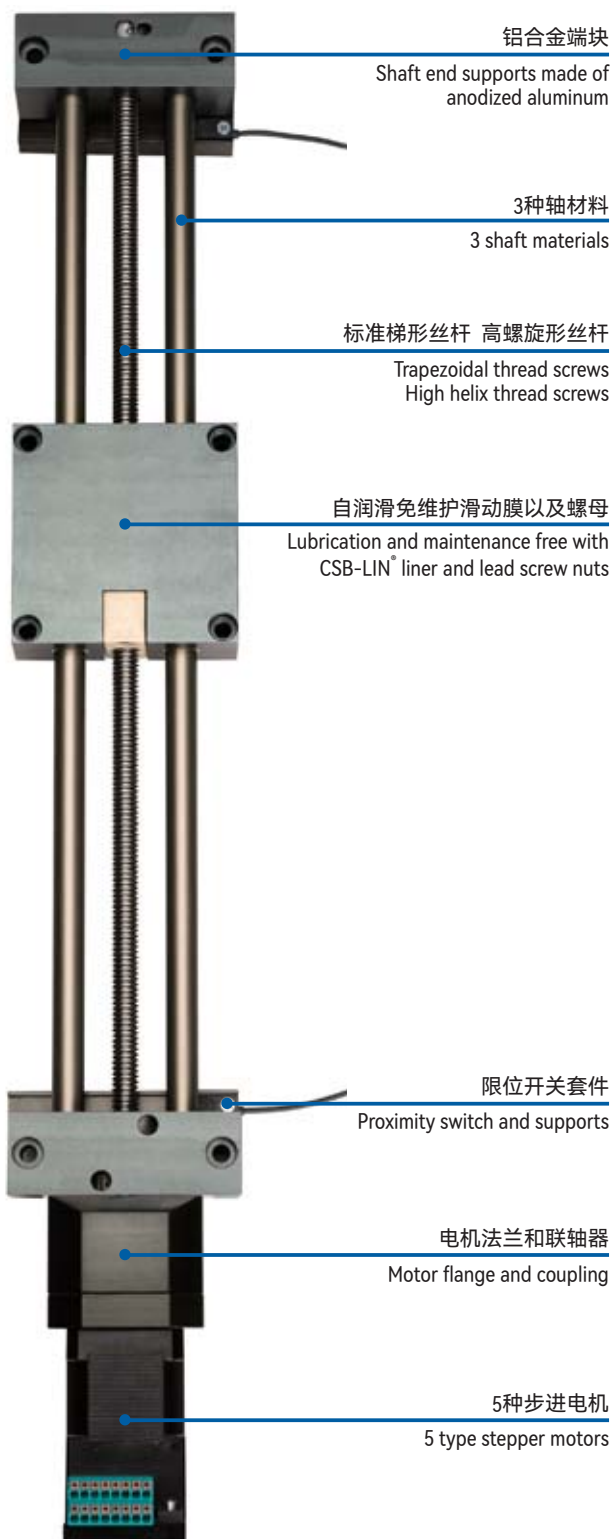

LMS02-E直线模组 Linear modules



LMS03-E直线模组 Linear modules

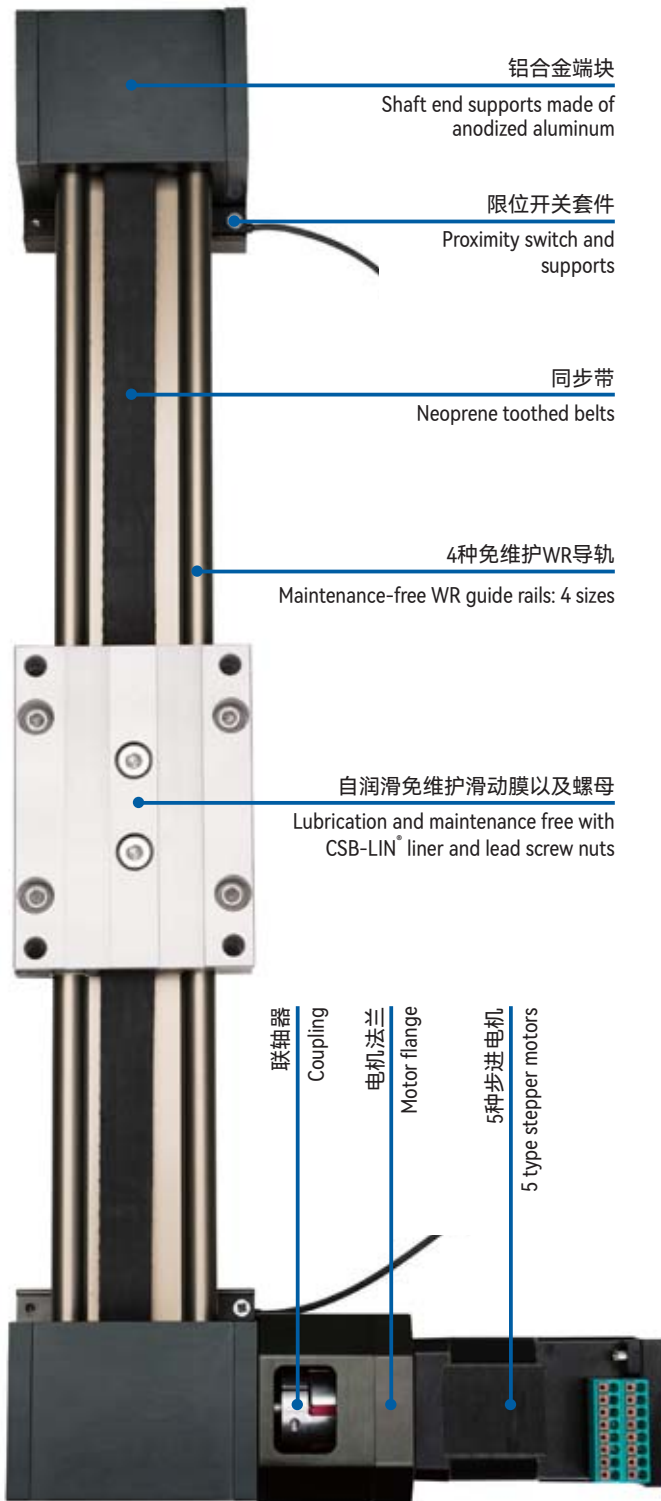

LMS04-E直线模组 Linear modules

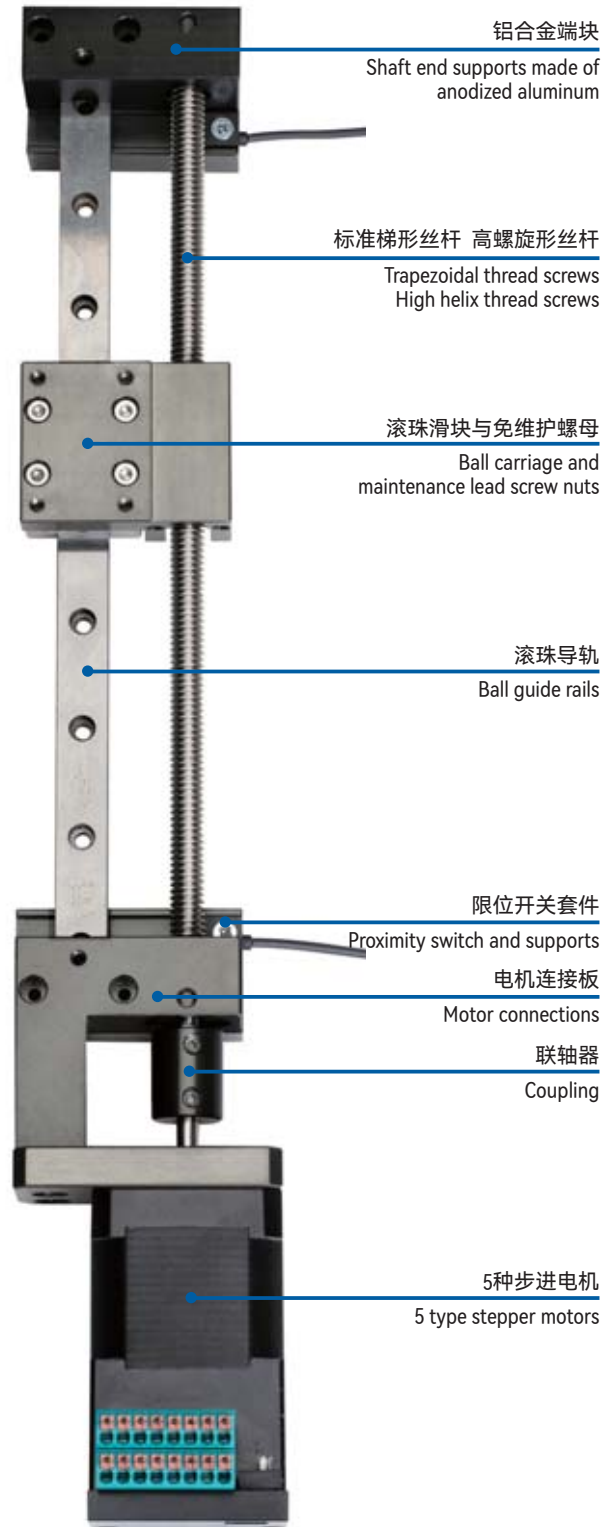

CSB-LMS[®] Lead Screw Drivers

CSB-LMS[®] 丝杆驱动



产品特性 Product features

- 丝杆传动组件是将旋转运动转换成直线运动的机器元件。CSB-LMS[®]丝杆传动组件采用CSB-EPB[®]材料制成的自润滑的塑料螺母，因此无需外部润滑就可实现长期运转。
- 高效耐用快速螺纹
- 标准梯形自锁螺纹
- 免维护，干运行
- 耐腐蚀、耐脏污、低噪音
- Screw drives are machine elements that convert rotary motion into linear motion. CSB-LMS[®] screw drives are always based on CSB-EPB[®] self-lubricating plastic nuts, thus enabling long-lasting operation without external lubrication.
- Efficient and durable CSB-LMS[®] high helix threads
- Self-locking trapezoidal standard threads
- Maintenance-free, dry operation
- Corrosion resistant, Resistant to dirt and Low-noise

梯形螺纹丝杆 Lead screws with trapezoidal thread



产品特性 Product features

- 左旋和右旋螺纹可选
- 可选材料：C45钢和不锈钢
- 可以根据客户图纸加工
- 螺旋线偏差 0.1mm/300mm
- 直线度 0.3mm/300mm
- 标准 DIN103 7e
- Thread: right- or left-hand
- Available materials: C45 steel /304 stainless steel
- Length and machining according to customer drawing
- Helix deviation 0.1mm/300mm
- Straightness 0.3mm/300mm
- Tolerance DIN103 7e

● 直径 Diameters: Ø8mm-Ø30mm

圆柱螺母 Lead screw nuts, round



产品特性 Product features

- 自润滑、低磨损
- 极低的摩擦系数
- 耐腐蚀，可用于液体介质环境
- 抵抗灰尘和无噪音运行
- 可选材料：EPB13, EPB5A
- Self lubricating and lower wear
- Best coefficient of friction
- Chemical resistant
- Dust resistant and quit running
- Available materials: EPB13 and EPB5A

● 直径 Diameters: Ø8mm-Ø30mm

*请扫描二维码登录我们的网站查询 Please scan the QR code to log in to our website: www.csb-ep.com

高螺旋线丝杆 Lead screws with high helix



产品特性 Product features

- 左旋和右旋螺纹可选
- 可选材料：304不锈钢
- 可以根据客户图纸加工
- 螺旋线偏差 0.1mm/300mm
- 直线度 0.3mm/300mm
- 标准 DIN103 7e
- Thread: right- or left-hand
- Available materials: 304 stainless steel
- Length and machining according to customer drawing
- Helix deviation 0.1mm/300mm
- Straightness 0.3mm/300mm
- Tolerance DIN103 7e

● 直径 Diameters: Ø6.35mm-Ø20mm

高螺旋线圆柱螺母 High helix nuts, round



产品特性 Product features

- 自润滑、低磨损
- 高效率传动
- 极低的摩擦系数
- 耐腐蚀，可用于液体介质环境
- 抵抗灰尘和无噪音运行
- 可选材料：EPB13, EPB5A
- Self lubricating and lower wear
- High efficiency drive
- Best coefficient of friction
- Chemical resistant
- Dust resistant and quit running
- Available materials: EPB13 and EPB5A

● 直径 Diameters: Ø6.35mm-Ø20mm

特殊螺母 Special nuts



产品特性 Product features

- 为LMS直线运动系统而特殊设计的丝杆螺母
- 自润滑、低磨损
- 极低的摩擦系数
- 耐腐蚀，可用于液体介质环境
- 抵抗灰尘和无噪音运行
- 节约安装空间，易装配
- 可选材料：EPB13, EPB5A
- Special design nuts for LMS linear motion system
- Self lubricating and lower wear
- Best coefficient of friction
- Chemical resistant
- Dust resistant and quit running
- Save space and Easy installation
- Available materials: EPB13 and EPB5A

● 直径 Diameters: Ø10mm, Ø14mm, Ø18mm

*请扫描二维码登录我们的网站查询 Please scan the QR code to log in to our website: www.csb-ep.com

CSB-LMS[®] Lead Screw Drivers

CSB-LMS[®] 丝杆驱动

丝杆支撑，固定式 Lead screw supports, fixed bearing side



● 直径 Diameters: \varnothing 10mm, \varnothing 18mm, \varnothing 24mm

产品特性 Product features

- 阳极氧化铝轴承座
- 灵活安装丝杠
- 丝杠直径: 10, 18和24 mm
- 通过内置塑料轴承实现自润滑
- Anodized aluminum bearing blocks
- Flexible mounting of the leadscrew
- Leadscrew Diameters: 10, 18 and 24 mm
- Lubricant-free through built-in plastic bearing

丝杆支撑，浮动式 Lead screw supports, floating bearing side

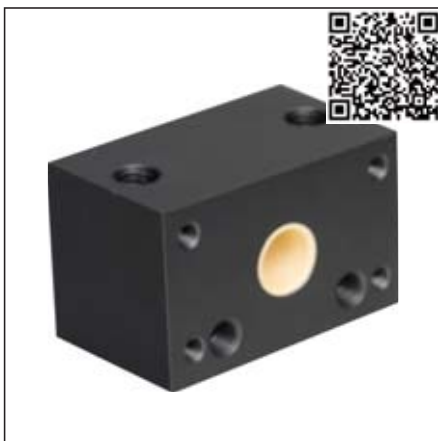

● 直径 Diameters: \varnothing 10mm, \varnothing 18mm, \varnothing 24mm

产品特性 Product features

- 阳极氧化铝轴承座
- 灵活安装丝杠
- 丝杠直径: 10, 18和24 mm
- 通过内置塑料轴承实现自润滑
- Anodized aluminum bearing blocks
- Flexible mounting of the leadscrew
- Leadscrew Diameters: 10, 18 and 24 mm
- Lubricant-free through built-in plastic bearing

丝杆支撑，滚动轴承 Lead screw supports, ball bearing-faster



● 直径 Diameters: \varnothing 10mm, \varnothing 18mm, \varnothing 24mm

产品特性 Product features

- 自润滑、免维护
- 快速连接安装
- 传输高转速
- 低摩擦
- 精准无间隙配合
- Lubricant- and maintenance-free
- Quick connection
- Transmission of high rotation speed
- Low friction
- Accurate and clearance-free

*请扫描二维码登录我们的网站查询 Please scan the QR code to log in to our website: www.csb-ep.com

CR01丝杆夹环，带螺纹 Lead screw clamping rings with thread

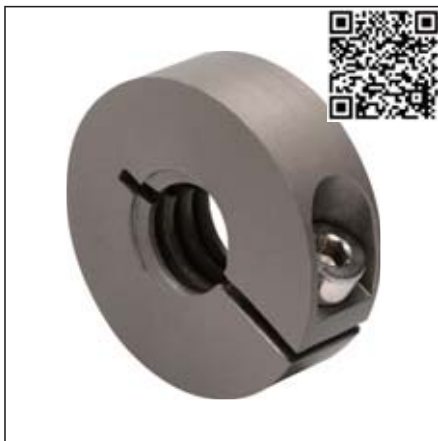

产品特性 Product features

- 直接与丝杆螺纹配合安装
- 配合梯形丝杆支撑客户解决方案
- 承受较高的轴向力
- 采用表面硬质氧化铝合金制成
- 带锁紧螺丝
- Ready to install in the screw
- Custom solutions for lead screw support
- Can absorb even high axial forces
- Clamping rings made from coated aluminum
- Screw included in delivery

● 直径 Diameters: Ø8mm-Ø24mm

CR02丝杆夹环，无螺纹 Lead screw clamping rings without thread

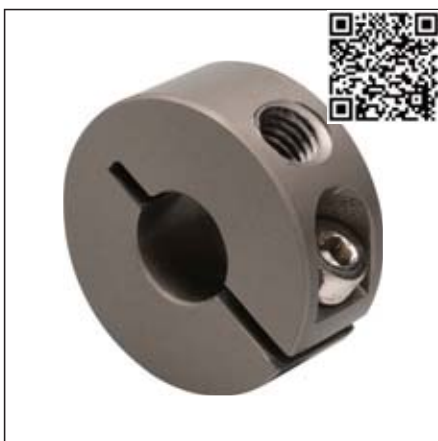

产品特性 Product features

- 直接与丝杆端安装
- 承受较高的轴向力
- 采用表面硬质氧化铝合金制成
- 带锁紧螺丝
- Ready to install in the end of screw
- Can absorb even high axial forces
- Clamping rings made from coated aluminum
- Screw included in delivery

● 直径 Diameters: Ø10mm-Ø24mm

系统附件 Accessories



步进电机
Stepper motors



步进电机控制器
Stepper motor controllers



联轴器
Flexible jaw couplings



电机法兰
Motor flange



限位开关
Proximity switches

*请扫描二维码登录我们的网站查询 Please scan the QR code to log in to our website: www.csb-ep.com

CSB-SFP® Semi-finished Products

CSB-SFP® 耐磨半成品

CSB-SFP 耐磨半成品 Semi-finished products



CSB自润滑工程塑料半成品为客户特殊尺寸轴承少量快速制作提供了可能；节省了额外的模具费用和提高了交货速度。而且可以直接用来加工尺寸或形状非标准件产品，为用户提供各种自润滑部件的解决方案。

CSB self-lubricated plastic semi-finished products are customized materials available by the customer special requirement of uncommon bearing sizes. It is possible for the mold cost saving and improves the delivery time. The non-standard bearings are available with this flexible solution.

技术数据表 Technical data table

材料性能 Material properties	标准 Standard	单位 Unit	M80	M81	M82	M83	MN73
颜色 Color	-	-	蓝色 Blue	绿色 Green	棕色 Brown	紫色 Purple	灰色 Grey
密度 Density	ISO1183	g/cm ³	1.15	0.94	1.45	1.10	1.48
最大吸湿率 Max. moisture absorption, 50%RH	ISO62	%	2.5	0.01	0.3	0.65	0.3
最大吸水率 Max. water absorption	ISO62	%	7.0	0.05	1.3	6.3	1.3
对钢动摩擦系数 Coefficient of sliding friction(steel)	ITS025	μ	0.10-0.30	0.05-0.15	0.05-0.15	0.10-0.18	0.05-0.20
极限PV值 Max. PV value	ITS026	N/mm ² ×m/s	0.25	0.20	0.40	0.40	0.30
弯曲模量 Flexural modulus	ISO178	MPa	3000	650	2400	2750	2350
弯曲强度 Flexural strength	ISO178	MPa	90	20	65	60	60
最大静载荷 Max. static load	ITS027	MPa	70	25	40	65	35
最大动载荷 Max. dynamic load	ITS028	MPa	36	6	17	33	14
邵氏硬度 Shore hardness	ISO868	D	80	62	75	70	74
连续运行温度 Long-term application temperature	ITS029	°C	+90	+80	+90	+90	+90
短时运行温度 Short-term application temperature	ITS029	°C	+180	+120	+120	+180	+120
最低运行温度 Lowest application temperature	ITS029	°C	-40	-100	-50	-40	-50
导热性 Thermal conductivity	ISO22007	W/m/K	0.24	0.40	0.25	0.30	0.25
线性热膨胀系数 Coefficient of thermal expansion	ISO11359	K ⁻¹ ×10 ⁻⁵	9	19	9	10	10
阻燃等级 Flammability	UL94	Class	HB	HB	HB	HB	HB
体电阻率 Volume resistance	IEC60093	Ω·cm	>10 ¹³	>10 ¹⁴	>10 ¹³	>10 ¹⁴	>10 ¹³
面电阻率 Surface resistance	IEC60093	Ω	>10 ¹²	>10 ¹⁴	>10 ¹²	>10 ¹⁴	>10 ¹²

*ITS: CSB内部测试标准 CSB company's internal test standards.

**除非特殊说明测试温度为23°C Test temperatures are 23°C unless otherwise stated.

材料性能 Material properties	标准 Standard	单位 Unit	MN70	MN71	MN73	EPB	EPB5A
颜色 Color	-	-	白色 White	白色 White	灰色 Grey	深灰 Dark grey	米色 Beige
密度 Density	ISO1183	g/cm ³	1.42	1.38	1.40	1.46	1.28
最大吸湿率 Max. moisture absorption, 50%RH	ISO62	%	0.3	0.3	0.3	0.3	0.3
最大吸水率 Max. water absorption	ISO62	%	1.4	0.5	0.5	1.2	0.5
对钢动摩擦系数 Coefficient of sliding friction(steel)	ITS025	μ	0.10-0.35	0.15-0.40	0.10-0.30	0.05-0.15	0.25-0.40
极限PV值 Max. PV value	ITS026	N/mm ² ×m/s	0.30	0.25	0.35	0.40	0.25
弯曲模量 Flexural modulus	ISO178	MPa	2300	5000	4200	2300	3600
弯曲强度 Flexural strength	ISO178	MPa	60	130	120	60	140
最大静载荷 Max. static load	ITS027	MPa	30	85	80	35	90
最大动载荷 Max. dynamic load	ITS028	MPa	13	45	41	15	46
邵氏硬度 Shore hardness	ISO868	D	76	81	80	75	80
连续运行温度 Long-term application temperature	ITS029	°C	+90	+110	+110	+80	+250
短时运行温度 Short-term application temperature	ITS029	°C	+110	+180	+180	+120	+300
最低运行温度 Lowest application temperature	ITS029	°C	-50	-40	-40	-40	-100
导热性 Thermal conductivity	ISO22007	W/m/K	0.25	0.25	0.25	0.20	0.24
线性热膨胀系数 Coefficient of thermal expansion	ISO11359	K ⁻¹ ×10 ⁻⁵	11	6	6	10	9
阻燃等级 Flammability	UL94	Class	HB	HB	HB	HB	V0
体电阻率 Volume resistance	IEC60093	Ω·cm	>10 ¹³	>10 ¹⁴	>10 ¹⁴	>10 ¹³	>10 ¹⁴
面电阻率 Surface resistance	IEC60093	Ω	>10 ¹²	>10 ¹⁴	>10 ¹⁴	>10 ¹²	>10 ¹³

材料性能 Material properties	标准 Standard	单位 Unit	EPB6	EPB7	EPB10	EPB13
颜色 Color	-	-	白色 White	米黄 Cream	黑色 Black	黄色 Yellow
密度 Density	ISO1183	g/cm ³	1.45	1.25	1.42	1.48
最大吸湿率 Max. moisture absorption, 50%RH	ISO62	%	0.3	1.3	0.1	0.3
最大吸水率 Max. water absorption	ISO62	%	1.2	6.5	0.5	1.3
对钢动摩擦系数 Coefficient of sliding friction(steel)	ITS025	μ	0.05-0.18	0.09-0.20	0.10-0.25	0.05-0.15
极限PV值 Max. PV value	ITS026	N/mm ² ×m/s	0.30	0.50	1.35	0.40
弯曲模量 Flexural modulus	ISO178	MPa	2300	3200	10000	2600
弯曲强度 Flexural strength	ISO178	MPa	60	75	210	60
最大静载荷 Max. static load	ITS027	MPa	35	60	125	35
最大动载荷 Max. dynamic load	ITS028	MPa	14	25	80	14
邵氏硬度 Shore hardness	ISO868	D	74	75	86	74
连续运行温度 Long-term application temperature	ITS029	°C	+80	+90	+250	+90
短时运行温度 Short-term application temperature	ITS029	°C	+120	+180	+315	+120
最低运行温度 Lowest application temperature	ITS029	°C	-40	-40	-100	-50
导热性 Thermal conductivity	ISO22007	W/m/K	0.20	0.24	0.60	0.25
线性热膨胀系数 Coefficient of thermal expansion	ISO11359	K ⁻¹ ×10 ⁻⁵	10	9	5	10
阻燃等级 Flammability	UL94	Class	HB	HB	V0	HB
体电阻率 Volume resistance	IEC60093	Ω·cm	>10 ¹³	>10 ¹³	>10 ⁵	>10 ¹³
面电阻率 Surface resistance	IEC60093	Ω	>10 ¹²	>10 ¹²	>10 ⁵	>10 ¹²

*ITS: CSB内部测试标准 CSB company's internal test standards.

**除非特殊说明测试温度为23°C Test temperatures are 23°C unless otherwise stated.

CSB-SFP[®] Semi-finished Products

CSB-SFP[®] 耐磨半成品

M80 耐磨棒 Round rods



● 直径 Diameters: Ø25mm-Ø100mm

产品特性 Product features

- 连续使用温度: -40/+90°C
- 自润滑、免维护
- 通用性较强
- 适合中高载荷
- 低成本选择
- Continuous working temperature: -40/+90°C
- Maintenance-free, self-lubricated
- Suitable for most application
- Suitable for medium and high load operation
- Low cost

M81 耐磨棒 Round rods



● 直径 Diameters: Ø15mm-Ø65mm

产品特性 Product features

- 连续使用温度: -100/+80°C
- 自润滑、免维护
- 低摩擦、耐磨损
- 抗冲击、低噪音
- 极低吸水性
- Continuous working temperature: -100/+80°C
- Maintenance-free, self-lubricated
- Low friction, anti-wear
- Impact resistance, low noise
- Low water absorption

M82 耐磨棒 Round rods



● 直径 Diameters: Ø10mm-Ø100mm

产品特性 Product features

- 连续使用温度: -50/+90°C
- 自润滑、免维护
- 特种润滑耐磨
- 低摩擦系数
- 长寿命
- Continuous working temperature: -50/+90°C
- Maintenance-free, self-lubricated
- Special lubricant and wear resistant
- Low friction coefficient
- Long service time

EPB 耐磨棒 Round rods



● 直径 Diameters: Ø15mm-Ø65mm

产品特性 Product features

- 连续使用温度: -40/+80°C
- 自润滑、免维护
- 特种润滑耐磨
- 低摩擦系数
- 长寿命
- Continuous working temperature: -40/+80°C
- Maintenance-free, self-lubricated
- Special lubricant and wear resistant
- Low friction coefficient
- Long service time

*请扫描二维码登录我们的网站查询 Please scan the QR code to log in to our website: www.csb-ep.com

EPB3M 耐磨棒 Round rods



● 直径 Diameters: Ø40mm

产品特性 Product features

- 连续使用温度: -40/+80°C
- 自润滑、免维护
- 特种润滑耐磨
- 低摩擦系数
- 长寿命
- Continuous working temperature: -40/+80°C
- Maintenance-free, self-lubricated
- Special lubricant and wear resistant
- Low friction coefficient
- Long service time

EPB5A 耐磨棒 Round rods



● 直径 Diameters: Ø10mm-Ø65mm

产品特性 Product features

- 连续使用温度: -100/+250°C
- 适合高载荷低速运用
- 高温下保持较高的承载能力
- 较广泛的化学抗性
- 符合FDA等级
- Continuous working temperature: -100/+250°C
- Suitable for high load and lovo speed operation
- High load capacity at higher temperature
- Good chemical resistance
- FDA grade

EPB6 耐磨棒 Round rods



● 直径 Diameters: Ø15mm-Ø65mm

产品特性 Product features

- 连续使用温度: -40/+80°C
- 自润滑、免维护
- 极低摩擦系数
- 耐磨性能优越
- FDA食品安全等级
- Continuous working temperature: -40/+80°C
- Maintenance-free, self-lubricated
- Low friction coefficient
- Good wear resistant
- FDA grade

EPB7 耐磨棒 Round rods



● 直径 Diameters: Ø40mm

产品特性 Product features

- 连续使用温度: -40/+90°C
- 自润滑、免维护
- 耐磨性能优越
- 极低摩擦系数
- Continuous working temperature: -40/+90°C
- Maintenance-free, self-lubricated
- Good wear resistant
- Low friction coefficient

*请扫描二维码登录我们的网站查询 Please scan the QR code to log in to our website: www.csb-ep.com

CSB-SFP® Semi-finished Products

CSB-SFP® 耐磨半成品

EPB10 耐磨棒 Round rods



● 直径 Diameters: \varnothing 10mm- \varnothing 65mm

产品特性 Product features

- 连续使用温度: -100/+250°C
- 自润滑、免维护
- 非常耐磨长寿命
- 极好的耐腐蚀性
- Continuous working temperature: -100/+250°C
- Maintenance-free, self-lubricated
- Good wear resistance with long service life
- Good chemical resistance

EPB13 耐磨棒 Round rods



● 直径 Diameters: \varnothing 15mm- \varnothing 80mm

产品特性 Product features

- 连续使用温度: -50/+90°C
- 适合干运行、免维护
- 不同轴材料磨损很小
- 较低的摩擦系数
- 适用于软轴
- 吸水性较低
- Continuous working temperature: -50/+90°C
- Maintenance-free dry operation
- Small wear off amount against various shaft materials
- Lower friction
- Suitable for soft shaft
- Low water absorption

MN70 耐磨棒 Round rods



● 直径 Diameters: \varnothing 15mm- \varnothing 65mm

产品特性 Product features

- 连续使用温度: -40/+90°C
- 自润滑、免维护
- 低摩擦系数
- 长寿命
- 符合FDA标准
- Continuous working temperature: -40/+90°C
- Maintenance-free, self-lubricated
- Low friction coefficient
- Long service time
- FDA grade

MN71 耐磨棒 Round rods



● 直径 Diameters: \varnothing 15mm- \varnothing 80mm

产品特性 Product features

- 连续使用温度: -40/+110°C
- 自润滑、免维护
- 适合在灰尘中运行
- 适合在潮湿环境中运行
- Continuous working temperature: -40/+110°C
- Maintenance-free, self-lubricated
- Suitable for operation in dusty environment
- Suitable for working in humid environment

*请扫描二维码登录我们的网站查询 Please scan the QR code to log in to our website: www.csb-ep.com

MN73 耐磨棒 Round rods



● 直径 Diameters: Ø15mm-Ø150mm

产品特性 Product features

- 连续使用温度: -40/+110°C
- 适合干运行、免维护
- 较低的摩擦系数
- 适合在潮湿环境中运行
- Continuous working temperature: -40/+110°C
- Maintenance-free dry operation
- Low friction coefficient
- Suitable for working in humid environment

MR4 耐磨棒 Round rods



● 直径 Diameters: Ø30mm-Ø40mm

产品特性 Product features

- 连续使用温度: -50/+90°C
- 适合干运行、免维护
- 较低的摩擦系数
- 适用于软轴
- 吸水性较低
- 低成本
- Continuous working temperature: -50/+90°C
- Maintenance-free dry operation
- Low friction coefficient
- Suitable for soft shaft
- Low water absorption
- Low cost

MN70 耐磨板 Anti-wear plates



● 厚度 Thickness: 8mm-30mm

产品特性 Product features

- 连续使用温度: -40/+90°C
- 自润滑、免维护
- 极低摩擦系数
- 耐磨性能优越
- FDA食品安全等级
- Continuous working temperature: -40/+90°C
- Maintenance-free, self-lubricated
- Low friction coefficient
- Good wear resistant
- FDA grade

MN71 耐磨板 Anti-wear plates



● 厚度 Thickness: 3mm-30mm

产品特性 Product features

- 连续使用温度: -40/+110°C
- 自润滑、免维护
- 适合在灰尘中运行
- 适合在潮湿环境中运行
- Continuous working temperature: -40/+110°C
- Maintenance-free, self-lubricated
- Suitable for operation in dusty environment
- Suitable for working in humid environment

*请扫描二维码登录我们的网站查询 Please scan the QR code to log in to our website: www.csb-ep.com

CSB-SFP® Semi-finished Products

CSB-SFP® 耐磨半成品

MN73 耐磨板 Anti-wear plates

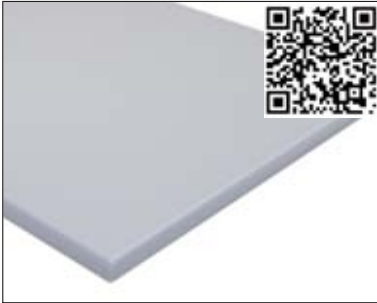

● 厚度 Thickness: 8mm-30mm

产品特性 Product features

- 连续使用温度: -40/+110°C
- 适合干运行、免维护
- 较低的摩擦系数
- 适合在潮湿环境中运行
- Continuous working temperature: -40/+110°C
- Maintenance-free dry operation
- Low friction coefficient
- Suitable for working in humid environment

M80 耐磨板 Anti-wear plates

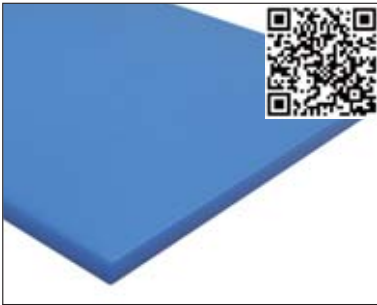

● 厚度 Thickness: 20mm-40mm

产品特性 Product features

- 连续使用温度: -40/+90°C
- 自润滑、免维护
- 通用性较强
- 适合中高载荷
- 低成本选择
- Continuous working temperature: -40/+90°C
- Maintenance-free, self-lubricated
- Suitable for most application
- Suitable for medium and high load operation
- Low cost

M81 耐磨板 Anti-wear plates

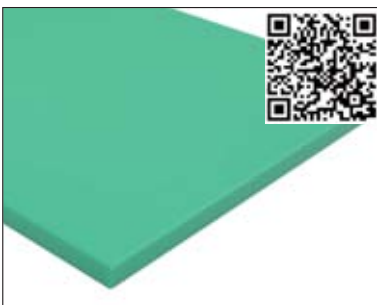

● 厚度 Thickness: 8mm-40mm

产品特性 Product features

- 连续使用温度: -100/+80°C
- 自润滑、免维护
- 低摩擦、耐磨损
- 抗冲击、低噪音
- 极低吸水性
- Continuous working temperature: -100/+80°C
- Maintenance-free, self-lubricated
- Low friction, anti-wear
- Impact resistance, low noise
- Low water absorption

M83 耐磨板 Anti-wear plates

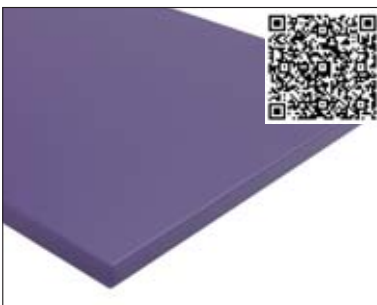

● 厚度 Thickness: 10mm-30mm

产品特性 Product features

- 连续使用温度: -40/+90°C
- 自润滑、免维护
- 低摩擦、耐磨损
- 抗冲击、低噪音
- 极小蠕变性
- Continuous working temperature: -40/+90°C
- Maintenance-free, self-lubricated
- Low friction, anti-wear
- Impact resistance, low noise
- Excellent dimensional stability

*请扫描二维码登录我们的网站查询 Please scan the QR code to log in to our website: www.csb-ep.com

EPB5A 耐磨板 Anti-wear plates

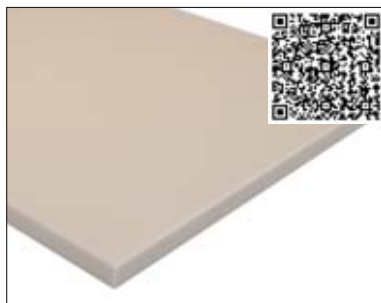

● 厚度 Thickness: 5mm-30mm

产品特性 Product features

- 连续使用温度: -100/+250°C
- 自润滑、免维护
- 非常耐磨长寿命
- 极好的耐腐蚀性
- Continuous working temperature: -100/+250°C
- Maintenance-free, self-lubricated
- Good wear resistance with long service life
- Good chemical resistance

EPB6 耐磨板 Anti-wear plates



● 厚度 Thickness: 8mm-30mm

产品特性 Product features

- 连续使用温度: -40/+80°C
- 自润滑、免维护
- 极低摩擦系数
- 耐磨性能优越
- FDA食品安全等级
- Continuous working temperature: -40/+80°C
- Maintenance-free, self-lubricated
- Low friction coefficient
- Good wear resistant
- FDA grade

EPB13 耐磨板 Anti-wear plates



● 厚度 Thickness: 6mm-30mm

产品特性 Product features

- 连续使用温度: -50/+90°C
- 适合干运行、免维护
- 不同轴材料磨损很小
- 较低的摩擦系数
- 适用于软轴
- 吸水性较低
- Continuous working temperature: -50/+90°C
- Maintenance-free dry operation
- Small wear off amount against various shaft materials
- Lower friction
- Suitable for soft shaft
- Low water absorption

Tribotape® 摩擦带 Tribo-tape liners



● 厚度 Thickness: 0.5mm
● 宽度 Width: 20mm-100mm

产品特性 Product features

- 连续使用温度: -196/+80°C
- 低摩擦系数
- 可用于水下环境
- 容易切割
- 标准宽度库存
- 宽度从20到100毫米
- Continuous working temperature: -196/+80°C
- Low coefficients of friction
- Available underwater
- Easy to cut
- Standard width from stock
- Individual widths from 20 to 100 mm

*请扫描二维码登录我们的网站查询 Please scan the QR code to log in to our website: www.csb-ep.com

CSB-PRB[®] Plastic Ball Bearings

CSB-PRB[®] 塑料滚动轴承



产品特性 Product features

CSB-PRB[®]系列塑料滚动轴承内外圈以及保持架均采用优质工程塑料制成，滚珠材料为不锈钢（选配）、玻璃、陶瓷等；PRB系列塑料滚动轴承具有良好的自润滑性能和耐腐蚀性能；突出的是比CSB-EPB[®]系列塑料滑动轴承具有其极高的运行速度，CSB-PRB[®]塑料轴承弥补了CSB-EPB[®]塑料轴承不能在高速运动使用的场合。

CSB-PRB[®] series plastic rolling bearing is made of high quality engineering plastic. The balls are Stainless steel, Glass, Ceramics materials. This series of bearings are with perfect self-lubricating feature and anti-corrosion feature. Comparing with the normal CSB-EPB[®] series plastic bushings, the CSB-PRB[®] series plastic rolling bearings are suitable to be applied under high speed and therefore meet the high speed application that normal CSB-EPB[®] is not workable.

PRB10 塑料滚动轴承 Plastic ball bearings



PRB10作为通用性最强的塑料滚动轴承具有良好的强度和耐磨性，由于其材料自身的润滑性噪音较低；此类轴承碱性环境下表现良好但不适合在酸性环境下长期运行。标准配置内外圈材料为：改良POM，保持架材料为：改良PA，滚珠材料为：玻璃球或不锈钢（选配）；长期连续使用温度-40~+80°C。

PRB10 has good strength and wear resistance as a generic plastic rolling bearings, the operation noise very low because the self-lubrication of the material; These bearings perform well in an alkaline environment but not for long-term operation in an acidic environment. The standard material of inner and outer ring: POM, cage material: PA, ball material: glass or stainless steel; The long-term operation temperature: -40 ~ +80°C.

PRB15 塑料滚动轴承 Plastic ball bearings



PRB15塑料滚动轴承材料具有极好的强度和耐磨性能，无论是在潮湿环境还是水下均保持良好的尺寸稳定性能；对有机溶剂以及过氧化氢等具有良好的抗性；标准配置内外圈材料为：改良PETR，保持架材料为：改良PA，滚珠材料为：玻璃或不锈钢（选配）；长期使用温度：-50~+120°C。

PRB15 Plastic Roller Bearings are with excellent strength and wear resistance. The dimensions of the bearings are remaining stable either in the humidity environment or in the water. It has good chemical resistance against the organic solvents or Hydrogen peroxide. The standard material of the inner and outer ring is PETR, the ball cage is PA, and the balls are glass or stainless steel. The working temperature range is -50 ~ +120°C.

PRB20 塑料滚动轴承 Plastic ball bearings

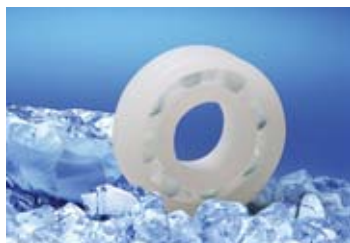

PRB20塑料滚动轴承具有低摩擦以及低温应用特性；此类轴承适合在酸碱交替环境下长期运行。标准配置内外圈材料为：改良UPE，保持架材料为：改良UPE，滚珠材料为：玻璃球或不锈钢（选配）；长期连续使用温度-150~+80°C。

PRB20 series of plastic rolling bearing with low friction and low working temperature properties; these bearings are suitable for long-term operation in the acid-base alternate environment. The standard material of inner and outer ring: UPE, cage material: UPE, ball material: glass or stainless steel; The long-term operation temperature: -150 ~ +80°C.

*请扫描二维码登录我们的网站查询 Please scan the QR code to log in to our website: www.csb-ep.com

PRB25 塑料滚动轴承 Plastic ball bearings



PRB25塑料滚动轴承材料是经过摩擦优化的耐磨材料，具有较低的摩擦系数；耐疲劳性较好；允许在高速下运转。耐碱、弱酸以及洗涤剂的腐蚀；标准配置内外圈材料为：改良PA，保持架材料为：改良PA，滚珠材料为：玻璃或不锈钢（选配）；长期使用温度：-40~+100°C。

PRB25 Plastic roller bearings material is friction optimized wear resistance material with low friction and good fatigue resistance. It is suitable for the high speed operation. The material is alkali, acid and detergent resistance. The standard material of inner and outer ring is PA, ball cage is PA and the balls are glass or stainless steel. The working temperature range is -40~+100°C.

PRB30 塑料滚动轴承 Plastic ball bearings



PRB30系列塑料滚动轴承具有极好的机械强度和耐磨性能，此产品能在150度的高温下正常使用，并具有极好的抗腐蚀性几乎能在所有的腐蚀环境下运行；标准配置内外圈材料为：改良PEEK，保持架材料为：改良PEEK，滚珠材料为：陶瓷；长期连续使用温度-100~+150°C。

PRB30 series of plastic rolling bearing has excellent mechanical strength and wear resistance, Max. operation temperature 250°C, these bearings has excellent corrosion resistance to almost all corrosive environment; The standard material of inner and outer ring: PEEK, cage material: PEEK, ball material: Ceramics; The long-term operation temperature: -100 ~ +150°C.

PRB40 陶瓷滚动轴承 Ceramic ball bearings



PRB40系列塑料滚动轴承具有耐高低温、高承载以及更好的抗腐蚀性性能；可应用在强酸、强碱、无机、有机盐、海水等领域。标准配置内外圈材料为：陶瓷，保持架材料为：改良PTFE或改良PEEK，滚珠材料为：陶瓷；长期连续使用温度-200~+250°C。

PRB40 series of plastic rolling bearing can work under very high temperature and very low temperature. These bearings with high load and the best corrosion resistance; these bearings are good working under acid, alkaline, organic and inorganic salt as well as in sea water environments; The standard material of inner and outer ring: Ceramics, cage material: PTFE or PEEK, ball material: Ceramics; The long-term operation temperature: -200 ~ +250°C.

BTU 万向滚珠轴承 Ball transfer units



塑料万向滚珠轴承与钢制轴承相比具有不导电、耐酸碱液、无需润滑、免维护、低摩擦、重量轻（最多可减少70%）、适用于真空或压力、盐水-证明，根据材料选择不含金属成分，运输玻璃等易碎物品，可用于爆炸性环境和无菌区域（例如医疗技术），可定制设计。

In comparison to steel units, ball transfer units out of plastics are non-conductive, resistant to acid and lye, no lubrication, maintenance-free low friction, low weight (up to 70 % less), appropriate for vacuum or pressure, saltwater-proof, free of metallic components depending on selection of materials, transport of fragile goods such as glass, available use in explosive atmosphere and aseptic areas (e. g. medical technology), customized design possible.



GFB-BB法兰滚动轴承 Flange ball bearings



GSB-BB方法兰滚动轴承 Flange ball bearings



GBB-BB底座滚动轴承 Pillow block ball bearings

塑料滚动轴承
Plastic Ball Bearings

www.csb-ep.com
sales@csb-ep.com

电话: 0573 84186133/84185527
Tel: 0086 573 84187009

CSB-PEC® Self-lubricated Rotary Chains

CSB-PEC® 扶梯端部自润滑回转链

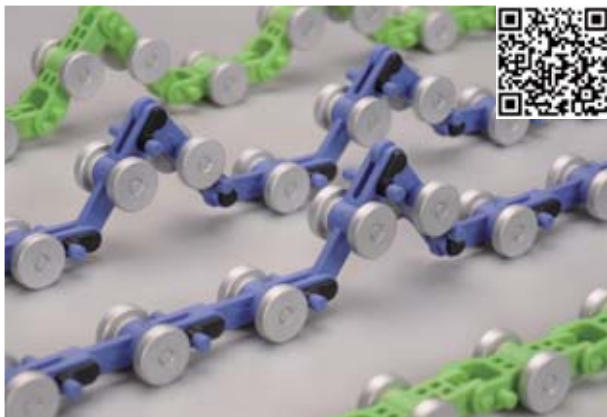

滚动轴承回转链 Rolling bearing rotary chains

扶梯回转链一般都是采用滚动轴承设计，扶手带与导轨摩擦产生大量的磨屑和灰尘，这些磨屑和灰尘对滚动轴承的正常工作和寿命造成了严重影响，室外运行滚动轴承还带来因生锈失效的问题，滚动轴承工作一段时间后容易出现噪音加大甚至卡死现象，容易导致扶手带磨损加剧损坏，扶梯运行系统负载增加，影响了电机使用寿命。



The design of the escalator rotary chain is usually with rolling bearings. There are a lot of containment and dust generated between the chain belt and the guide rail during the operation, therefore it induces damages to the rolling bearing and reduces the service life of the bearing and affects the performance of the bearing. Furthermore, outdoor operation of the escalator may cause corrosions to the rolling bearings. Under the above conditions, the rolling bearing in the chain is easy to cause failure of the operation of the chain. It may damage the chain system or consequently damage the driving motor in the escalator system.

CSB-PEC®自润滑回转链 Self-lubricated rotary chains

CSB-PEC®自润滑回转链关键转动部位采用了自润滑塑料轴承设计，自润滑塑料轴承由EPB15材料制成解决了轴承需要加油维护的问题，而且EPB15材料对灰尘有极好的抵抗能力，采用此材料制成的自润滑轴承能在环境非常恶劣的情况下长期正常工作；CSB-PEC®新型回转链长期平稳低噪音运行成功解决了滚动轴承回转链长期存在的噪音和滚动轴承容易卡死的缺陷；CSB-PEC®回转链上的金属部件均采用了特殊的表面处理技术可以确保在户外长期平稳运行。



The rotation parts of CSB-PEC® series rotary chain are with self-lubricated plastic bearings, the material CSB-EPB15 used in the plastic bearings provides maintenance free feature of the chain system and with the anti-dust and anti-corrosion feature of the bearing material, the chain system could be free to operate under critical conditions. The long term stable operation with low noise design of CSB-PEC® chain prevent the chain system from stuck and operation failure comparing with the traditional rolling bearing design. The metal parts of the CSB-PEC® chain are specially treated for the long term outdoor operation.

*请扫描二维码登录我们的网站查询 Please scan the QR code to log in to our website: www.csb-ep.com



材料结构 Material structure



CSB-FWB®材料以高强度玻璃纤维增强高温环氧树脂作为承载层，以特种纤维和PTFE纤维作为滑动层，使得轴承在高载低速工况条件下具有优良的耐磨性和很低的摩擦系数，甚至可以在长时间不加油的情况下仍能发挥良好的自润滑特性和很高的轴承比压。由此我们开发了可以适合不同工况下的多种自润材料。

The back material of CSB-FWB® materials is high strength glass fiber with epoxy resin and the lubricating layer of it is PTFE wound fiber or special lubricating fiber. Therefore, this special structure performs an outstanding anti-wear feature and low friction coefficient under high load and low speed condition. Furthermore, this absolutely new idea gives better solution for high load and excellent wear resistance possibility.

典型特征 Typical features

- 极高的动承载能力，最高140Mpa;
- 优秀的耐磨性能;
- 极低的摩擦系数，摩擦系数<0.12;
- 长期干运行，不推荐加油。
- Very high load capacity, Max. 140Mpa;
- Very good chemical resistance;
- Lower friction and good wear properties. Friction coefficient<0.12;
- Long time dry operation without oil.

技术数据表 Technical data table

材料性能 Material properties	标准 Standard	单位 Unit							
			CRM	CRB	CRG	CRH	CRP	CRW	CRF
密度 Density	ISO1183	g/cm ³	1.95	1.95	1.95	1.95	1.95	1.95	1.30
最大吸水率 Max. water absorption	ISO62	%	0.1	0.1	0.1	0.1	0.1	0.1	0.5
极限PV值 Max. PV (dry)	ITS026	N/mm ² ×m/s	1.8	1.8	2.0	2.0	1.6	1.8	1.2
摩擦系数 Coefficient of friction	ITS025	μ	0.05~0.15	0.03~0.12	0.03~0.12	0.05~0.15	0.02~0.12	0.02 ~ 0.10	0.08~0.30
连续运行温度 Long-term application temperature	ITS029	°C	+160	+160	+160	+200	+160	+100	+130
短时运行温度 Short-term application temperature	ITS029	°C	+180	+180	+180	+260	+180	+160	+160
最低运行温度 Lowest application temperature	ITS029	°C	-100	-100	-100	-100	-100	-100	-40
最高速度 Max. Speed	ITS032	m/s	0.20	0.20	0.20	0.16	0.40	0.40	0.13
抗压强度 Compressive strength	ITS033	MPa	420	420	420	620	420	420	300
最大静载荷 Max. static load	ITS027	MPa	240	240	240	420	240	240	150
最大动载荷 Max. dynamic load	ITS028	MPa	120	140	160	160	30	120	45
邵氏硬度 Shore hardness	ISO868	D	95	95	95	95	95	95	90
线性热膨胀系数(25 ~ 150°C) Linear coef. of thermal Expansion	ISO11359	10 ⁻⁶ ×K ⁻¹	13	13	13	13	13	13	40

*ITS: CSB内部测试标准 CSB company's internal test standards.









**除非特殊说明测试温度为23°C Test temperatures are 23°C unless otherwise stated.

*请扫描二维码登录我们的网站查询 Please scan the QR code to log in to our website: www.csb-ep.com

DURAMOV® Plastic Cable Chains

DURAMOV® 工程塑料电缆拖链

DURAMOV® 电缆拖链参数 Cable chains

系列 Series	开启原理 Opening principle	内高 Hi Inner height [mm]	最大电缆 外径 Max. cable outer diameter [mm]	内宽 Bi Inner width [mm]	外高 Ha Outer height [mm]	外宽 Ba Outer width [mm]	弯曲半径 R Bend radius [mm]	节距 T Link pitch [mm]
C01 微型电缆拖链 Micro cable chains, Closed design								
沿拖链外侧横杆不可打开 For the smallest applications. One-piece, non-openable								
		07	8	7-30	10	12-35	15-48	16.7
		10	8	10-30	12	14-34	18-38	20
		15	12	16-50	19.3	24.2-58.2	25-48	20
C11 易填充微型电缆拖链 Micro cable chains, Opening design								
易填充电缆线, 内侧横杆为分离式设计 Fill the cable quickly and easily; Split crossbar along the inner radius								
		05	3	5-10	8	8.7-13.7	10-18	10
		07	4.5	7-30	10	12-35	15-48	16.7
		10	6.5	10-20	15	16.5-26.5	18-38	20
C21 可打开微型电缆拖链 Micro cable chains, Openable along the outer radius								
沿拖链外侧方向打开 Fill the cable quickly and easily; Openable along the outer radius								
		15	12	16-40	19.3	24.2-48.2	28-48	20
		20	16	25-50	25	36-61	28-48	30.5
C31 微型可打开电缆拖链 Micro cable chains, openable along one side								
两片式设计, 可沿内侧或外侧打开 Two-pieces design, Openable along the outer radius or inner radius								
		10	8	10-30	15	17.4-37.4	18-38	20
		15	12.5	16-50	19.5	23.8-57.8	28-48	20
		20	16	25-50	25	36-61	28-48	30.5
C02 通用型电缆拖链 Universal cable chains								
沿拖链内外侧方向可打开 For almost any application. Crossbars removable along the inner and outer radius								
		18	16	38-125	28	54-141	38-150	40
		25	23	38-125	35	54-141	55-250	46
		35	32	50-150	50	66-194	63-250	56
		45	42	75-175	64	95-270	75-300	67
C03 重载型电缆拖链 High load cable chains								
每节带横杆 - 加强型 Strong chain with crossbars every link								
		32	28	50-200	54	73-223	63-300	56
		42	38	50-200	64	76-226	75-350	67
		56	50	100-300	84	134-334	135-400	91
		80	72	100-300	108	148-298	150-500	111
C04 静音型电缆拖链 Quiet cable chains, light and cleanroom suitable								
特殊结构与小节距设计静音无尘运行 Special design and small pitch for quite and cleanroom, Openable along the inner and outer radius								
		28	25	30-60	35	46-76	55-150	22

*请扫描二维码登录我们的网站查询 Please scan the QR code to log in to our website: www.csb-ep.com

- 不适用 Inapplicable ○ 可选配 Optional ● 标准 standard ■ 特别适合 Especially suitable

最大架空负载 Unsupported fill weight max. [kg/m]	最大架空长度 Unsupported length max. [m]	最大拖行长度 Long travel max. [m]	内部分隔 Internal divider		防爆/防静电 ATEX/ESD 	无尘室 Cleanroom 	阻燃等级 UL94 	低噪音 Low noise 	二维码 QR code
			竖分隔片 Vertical separators 	横分隔片 Horizontal separators 					
0.37	≤ 0.5	-	-	-	○	●	HB	●	
0.37	≤ 0.5	-	-	-	○	●	HB	●	
0.75	≤ 0.7	-	-	-	○	●	HB	●	
0.25	≤ 0.3	-	-	-	-	●	V2	●	
0.37	≤ 0.5	-	-	-	-	●	V2	●	
0.37	≤ 0.5	-	-	-	-	●	V2	●	
0.50	≤ 0.7	-	-	-	○	-	HB	●	
0.50	≤ 0.7	-	-	-	○	-	HB	●	
0.50	≤ 0.7	-	-	-	○	-	HB	●	
0.65	≤ 1.0	-	-	-	○	-	HB	●	
0.65	≤ 1.0	-	-	-	○	-	HB	●	
5	≤ 1.8	-	○	○	○	-	HB	-	
5	≤ 2.4	-	○	○	○	-	HB	-	
8	≤ 2.8	-	○	○	○	-	HB	-	
13	≤ 3.7	-	○	○	○	-	HB	-	
15	≤ 3.0	200	○	○	○	-	HB	-	
38	≤ 4.2	300	○	○	○	-	HB	-	
75	≤ 5.0	400	○	○	○	-	HB	-	
75	≤ 5.8	400	○	○	○	-	HB	-	
3	≤ 1.0	-	○	-	-	●	HB	■	

DURAMOV[®] Plastic Cable Chains

DURAMOV[®] 工程塑料电缆拖链

DURAMOV[®] 电缆拖链附件参数 Accessories

分隔片 Strain relief separators

将链内空间按需要分隔开电缆、油管、气管等起到保护作用
The separator separates inside space of the chain to protect cables, oil hoses, gas hoses, etc.



C02竖分隔片
Vertical separators



C03竖分隔片
Vertical separators



C04竖分隔片
Vertical separators



横分隔片
Horizontal separators



应力件 Strain relief elements



C02 C型支架
C-profile supporter
安装在拖链接头内部
Mounted on the inside of the chain brackets



C02消除应力元件
Tiewrap elements
配合C型槽与扎带使用
Used with C-profile supporter and tiewraps



C03 C型支架
C-profile supporter
可选安装在拖链接头内部或外部
Mounted on the inside or outside of the chain brackets



C03消除应力元件
Tiewrap elements
配合C型槽与扎带使用
Used with C-profile supporter and tiewraps



滑行垫 Sliding pads for cable chains



C03滑行垫
Sliding pads for cable chains
用于C03塑料电缆拖链长行程保护
Used for C03 cable chains long stroke protection



电缆夹 Cable clamp



电缆夹
Cable clamp
多层可选，配合C型槽用于固定电缆
Muti-layer available, Used to fix cables with C-profile supporter



*请扫描二维码登录我们的网站查询 Please scan the QR code to log in to our website: www.csb-ep.com

塑料电缆拖链

www.csb-ep.com
sales@csb-ep.com

电话: 0573 84186133/84185527
Tel: 0086 573 84187009

DURAMOV® 波纹管 Bellows

系列 Series	类型 Type	内径 Bi Inner diameter [mm]	外径 Ba Outer diameter [mm]	弯曲半径 R Bend radius [mm]	架空长度 Unsupported length [m]	二维码 QR code
BL01 波纹管电缆拖链 Quiet and cleanroom cable chains						
用于多种场合保护电缆并可实现柔性运动 Used to protect cables in mutiple applications and flexible movement						
	封闭 Close	10-48	13-54.5	20-90	≤0.3	
	开口 Open	10-48	13-54.5	20-90	≤0.3	
BL02 波纹管电缆拖链 Quiet and cleanroom cable chains						
用于多种场合保护电缆并可实现柔性运动 Used to protect cables in mutiple applications and flexible movement						
	封闭 Close	10-48	13-54.5	20-90	≤0.3	
	开口 Open	10-48	13-54.5	20-90	≤0.3	

波纹管附件 Accessories						
	支架 Brackets 用于长行程支撑波纹管 Used to support bellows in long-travall applications			快速接头 Quick connectors 快速连接无需工具 Quickly connected without tools		
	防水接头 Water-proof connectors 用于潮湿或液体飞溅环境 Used for wet or liquids environment			直角接头 Right-angle connectors 用于需要直角转向应用 Used for right-angle applications		

*请扫描二维码登录我们的网站查询 Please scan the QR code to log in to our website: www.csb-ep.com

声明:

本产品目录中的信息数据是基于我们当前对CSB产品的现有了解，仅作为用户设计参考使用；本产品目录中的信息数据不能直接引用至用户实际工况。CSB建议用户通过特定的试验来验证CSB产品是否适用于用户实际工况。对于使用CSB产品所可能导致的任何损失，CSB公司不承担赔偿责任。由于材料和产品技术不断更新，我们保留变更产品信息数据的权利。

Acknowledgement:

The information and data, contained in the catalogue, are induced by our understanding of the stated products. These information and data are only references during the user designation and application. The designation and application data provided by CSB could not be directly applied to the real application conditions. A specific test is recommended for the practical application environment to ensuring the suitable use of CSB products. Any damages or lost caused by improper use of CSB bearings will not be warranted by CSB. Due to the materials and techniques are continuously updated, we reserve the right to change the necessary data and information without advanced notice in time.

[Https: //www.csb-ep.com](https://www.csb-ep.com)

浙江长盛塑料轴承技术有限公司
地址: 浙江省嘉善惠民街道汾湖路6号
邮编: 314100
Tel: 0573-84186133/84185527
E-mail: sales@csb-ep.com

Zhejiang CSB Plastic Bearing Technology Co.,Ltd.
Add: No.6, Fenu Road, Huimin Sub-district, Jiashan, Zhejiang, China
Zip Code: 314100
Tel: 0086 573 84187009/84187672
E-mail: sales@csb-ep.com

总部: 浙江长盛滑动轴承股份有限公司
地址: 浙江嘉善经济开发区鑫达路6号
[Https: //www.csb.com.cn](https://www.csb.com.cn)

Zhejiang Changsheng Sliding Bearing Co., Ltd.
Add: No.6 Xinda Road, Economic Development Zone,
Jiashan, Zhejiang, China.

▣ CSB PLASTIC agent or distributor



CSB/CAT.063
Print: 04/2023